

24
MAGALOG

BRUMBERG

Light.
For generations.

EFFICIENT.

SUSTAINABLE..

INNOVATIV.

**Light.
Highlights.**

DIVERSE.

LOOP.
100% recycled
ocean plastic.

Hotel and restaurant.
Stylish, efficient,
inviting.

Product highlights.
LED panels, down-
lights and much
more.

PRICES VALID FROM 01/04/2024

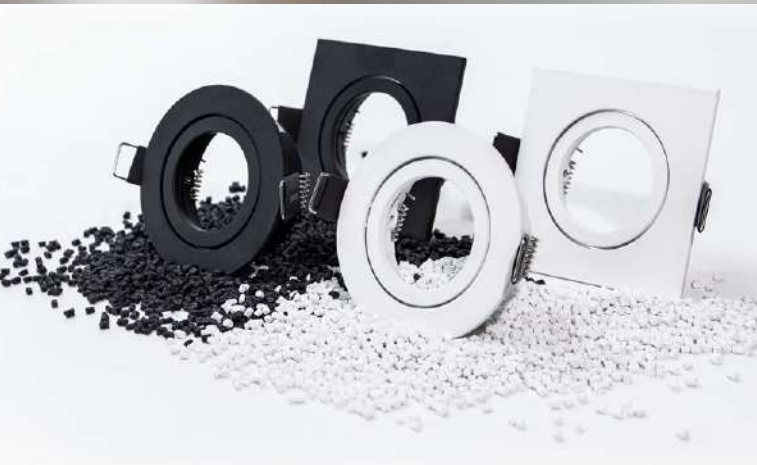
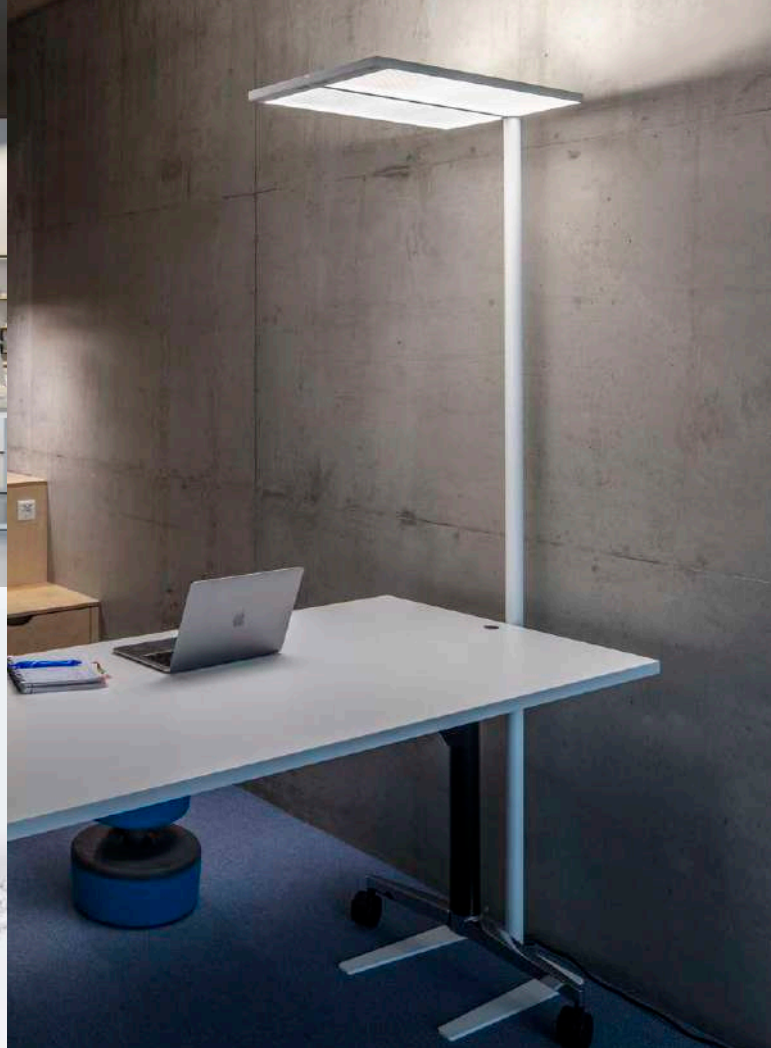
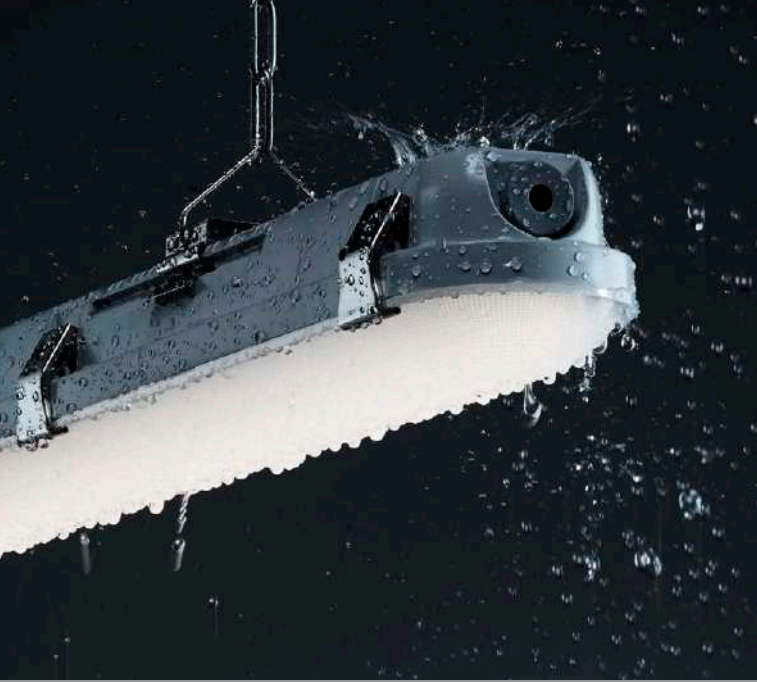

Contents

Indoor lighting

| | |
|------------------------------------|--------|
| 01 LED panel luminaires | p. 08 |
| 02 Spots and spotlight systems | p. 14 |
| 03 Free-standing office luminaires | p. 78 |
| 04 Ring lights and light channel | p. 100 |
| 05 Lights and light sets | p. 130 |
| 06 Industrial luminaires | p. 210 |
| 07 QUALITYFLEX LED flex stripes | p. 234 |

Outdoor lighting

| | |
|--------------------------------|--------|
| 08 Ceiling-recessed luminaires | p. 298 |
| 09 Ceiling-mounted luminaires | p. 308 |
| 10 Wall-recessed luminaires | p. 316 |
| 11 Wall luminaires | p. 320 |
| 12 Solar luminaires | p. 370 |
| 13 Ground-recessed luminaires | p. 380 |
| 14 Ground spike luminaires | p. 394 |
| 15 Bollard luminaires | p. 404 |
| 16 LED floodlights | p. 434 |
| Terms and Conditions | p. 486 |



Editorial



Light. Highlights.

Versatile lighting solutions for your projects.

At BRUMBERG, our vision is not only to create light, but also to shape a sustainable and efficient future.

At a time when environmental protection is a top priority, we are constantly preparing our company and our products for the requirements of today and the future and adapting them step by step. We see energy efficiency as a key factor for a sustainable future. We therefore rely on state-of-the-art technologies that not only extend the service life of our luminaires, but also minimise energy consumption.

Progress is unstoppable, and at BRUMBERG we are committed to continuous innovation. We are constantly working on developing products that are not only aesthetically pleasing, but also set new standards in terms of technology. From intelligent lighting control systems to designs that blend harmoniously into modern environments, innovation is the engine that drives us. As a company, we are aware of our responsibility towards the environment and future generations.

In this catalogue you will find not only tried and tested

classics, but also brand new products based on the latest technological developments. From energy-efficient LED technologies to intelligent solutions for flexible interior design – our innovations set new standards in terms of functionality and design.

You can rely on our project expertise to develop customised solutions for your individual requirements. Discover the future of lighting and be inspired by our products and project insights – design the lighting landscape of your projects together with us!

Johannes and Benedikt Brumberg

Handwritten signatures of Johannes and Benedikt Brumberg in black ink. The signatures are fluid and cursive, written in a professional style.

Light. For a better quality of life.

Brumberg – your partner for sustainable lighting.



Ecological success, conservation of natural resources and social commitment.

“Finding the right balance for the future. For us, sustainability means future viability. Or simply do the right thing. And if something is sustainable, it is sensible in the long term.

For us, this means finding the right balance between ecology, economy and social responsibility and making it an integral part of the family-run company.

In all our endeavours, we look beyond the end of our nose: for future generations.”

- Johannes and Benedikt Brumberg, *Managing Directors*



Efficient, clean and sustainable lighting solutions.

Brumberg in concrete terms.

Ökoprofit certification.

Resource-efficient management.
We're taking part.

Goal: To significantly reduce our CO2 footprint. At company level, we have been certifying our entire company processes with Ökoprofit since December 2021. This affects our CO2 footprint at the site, from transport routes to product development.



WaldLokal.

Regional support for the Sauerland forest.

Forestry that creates forests for tomorrow that are naturally suitable for the future, can be cultivated and can become indigenous to the region.



Cradle-2-Cradle certification.

Designing products sustainably.

We are pursuing C2C certification with our first product developments. The cradle-to-cradle principle describes an integrated and consistent circular economy. In this process, products are broken down into pure source materials after use, whereby the material quality is retained and returned to technical cycles.



LOOP®. Light Of Ocean Plastic.

The first certified LED recessed luminaire housing made from 100% Recycled Ocean Plastic.

Plastic waste in the sea is a global catastrophe that we need to do something about. We contribute to this with the first luminaire whose plastic content consists of 100 per cent "Recycled Ocean Plastic".

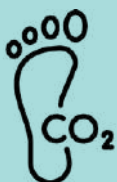

40.2 tonnes



45,399 kWh

We are on our way.

Savings. Forecast figures for the year 2024.

Further information about sustainability at Brumberg can be found online:

www.brumberg.com/de/nachhaltigkeit





01

LED panel luminaires.

Excellent lighting and
simple installation.



LED panel luminaires.

Always the right light.

The square and rectangular panel luminaires are suitable **for all modular ceiling systems**. The microprismatic version (UGR<19) is also optimally suited for use **as workplace lighting**. This Unified Glare Rating is authoritative for office rooms and guarantees **glare-free work at the VDU workstation**. The ultra-flat design with stepped frame not only allows it to merge with the ceiling, but also enables simple installation.

LED LIGHTING
FUNDING

BEG

Excellent in
price-performance



Eligible for BEG.

Up to 141 lm/W
at L80B10 > 50,000 hrs.



VDU workstation-compatible / compliant with workplace regulations.

UGR < 19 according to EN 12464-1.
Luminance limitation < 3,000 cd/m² at 65°.



Supremely efficient.

System efficiency up to 141 lm / W.
High light transmission 90%.



Durable.

Optimal thermal management due to
aluminium frame system.



Ultra-flat and torsionally rigid.

Despite slender design with
a height of 11 mm.



Stepped frame system.

Visually appealing due to seamless
integration into the OWA ceiling appearance.



High-quality light guide.

Made of non-yellowing PMMA.
In microprism or opal.



Multi-lumen.

Brightness/luminous flux adjustable in 4
stages (switchable) or 8 stages (DALI).



Various light colours.

3,000 K, 4,000 K or Tunable White:
Dynamic white light from 2,700 K - 6,500 K.
(HCL-capable for light with feel-good effect).



Extremely cost-effective.

Lower operating costs due to fewer
luminaires on account of high light power up
to 5,600 lm.



230 V AC & DC operation.

Operating units are both AC- and
DC-capable and can therefore also be
integrated into emergency power supply
systems.



Fast installation.

Generously-sized connection compartment
on primary side optimally suited for
through-wiring.
Reverse polarity-protected plug connection
with latch on secondary side.



Control.

on/off,
DALI-2 (push dim),
DALI DT8,
TunableWhite.



5 mounting options.

Usable as pendant luminaire, lay-in ceiling
luminaire, ceiling-mounted or
ceiling-recessed luminaire in two versions
(spring and frame technology).



Available in various sizes.

595 x 595 mm, 620 x 620 mm,
1,245 x 308 mm, 1,495 x 295 mm,
1,545 x 308 mm



Standards/checks.

ENEC, D classification, TÜV Süd, SELV, CE,
EL (IEC 61347-2-13 standard).



Flicker-free.

100 % light intensity on switch-on.
No flickering, no fluttering.



Optimal replacement for fluorescent lamps.

Saving of energy and maintenance costs.

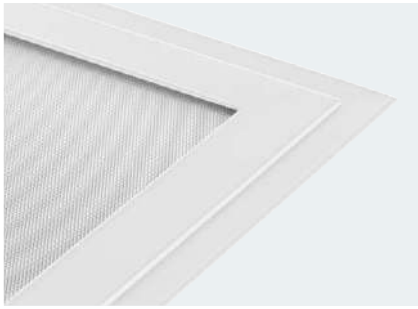

Microprismatic cover. The structured surface is homogeneous at a viewing distance of 50 cm or more.

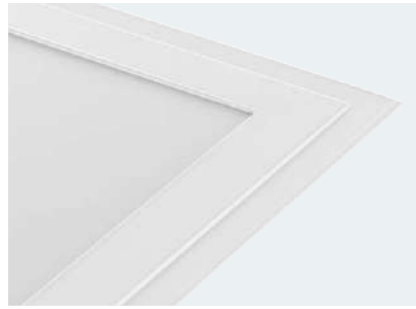

Opal cover.



Power supply unit with large connection compartment for simple, fast and convenient commissioning (photo: switchable version).

Did you know?

Since 2021, the Federal Ministry for Economic Affairs and Climate Action has bundled the previous schemes for the funding of energy efficiency and renewable energies within the framework of the Climate Action Programme 2030. The BEG (Federal Funding for Efficient Buildings) subsidises and supports the energy-related renovation of buildings for a further reduction in CO₂ emissions – including the replacement of lighting installations in non-residential buildings.

Take advantage of the funding possibilities now and secure a grant of up to 15 %.

Further information is available at: www.brumberg.com/de/produkte/li-cht-highlights/beg-foerderung/



Ultra-flat design.
11 mm.

The elegant LED panel luminaires. Functional and efficient.

The delicate frame design blends almost seamlessly and inconspicuously into the ceiling appearance. The silk m look gives the LED panel a noble appearance.

The inner values also impress: the performance values exceed today's requirements. The high efficiency of the luminaire of at least 120 lm/W makes it eligible for an LED lighting fund according to BEG and thus makes the LED panels particularly interesting for use in non-residential buildings.

LED LIGHTING
FUNDING

BEG

Areas of application.

Offices, reception and meeting areas, retail and wholesale premises, hotels, health service, showrooms, corridors, side rooms, modern living rooms or bathrooms.

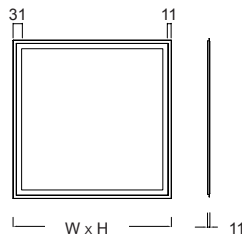

Set incl. converter for 230 V mains voltage

Lamp: LED, colour: white (RAL 9016),
input voltage: 220 – 240 V AC, 220-240 V DC, 50 – 60 Hz,
colour rendering: CRI > 80, SDCM < 3, material: aluminium / PMMA

Switchable: Multi-lumen operating unit with through-wiring
DALI-2: Multi-lumen operating unit with through-wiring
DALI (DT8): Multi-lumen operating unit with through-wiring

Service life: L80/B10, > 50,000 hrs. (ta: +25 °C)

| Article no. | Series name | Dimensions in mm | Colour temp. | Beam angle | Cover | UGR | Control | Power output | Luminous flux | System efficiency | Price in € |
|-------------|-------------|------------------|-------------------|------------|------------|----------|-----------------------|--------------|---------------|-------------------|------------|
| 32050073 | PINOS | 595 x 595 | 3,000 K | 85° | Microprism | UGR < 19 | switchable | 32 W | 4,000 lm | 125 lm/W | 109.90 |
| 32050074 | PINOS | 595 x 595 | 4,000 K | 85° | Microprism | UGR < 19 | switchable | 32 W | 4,200 lm | 131 lm/W | 109.90 |
| 32051073 | PINOS | 595 x 595 | 3,000 K | 85° | Microprism | UGR < 19 | DALI-2 | 32 W | 4,000 lm | 125 lm/W | 129.90 |
| 32051074 | PINOS | 595 x 595 | 4,000 K | 85° | Microprism | UGR < 19 | DALI-2 | 32 W | 4,200 lm | 131 lm/W | 129.90 |
| 32052073 | PINOS | 595 x 595 | 3,000 K | 120° | Opal | UGR < 22 | switchable | 32 W | 4,200 lm | 131 lm/W | 99.90 |
| 32052074 | PINOS | 595 x 595 | 4,000 K | 120° | Opal | UGR < 22 | switchable | 32 W | 4,500 lm | 141 lm/W | 99.90 |
| 32053073 | PINOS | 595 x 595 | 3,000 K | 120° | Opal | UGR < 22 | DALI-2 | 32 W | 4,200 lm | 131 lm/W | 119.90 |
| 32053074 | PINOS | 595 x 595 | 4,000 K | 120° | Opal | UGR < 22 | DALI-2 | 32 W | 4,500 lm | 141 lm/W | 119.90 |
| 32054074 | PINOS | 595 x 595 | 2,700 K – 6,500 K | 85° | Microprism | UGR < 19 | DALI-2, DALI DT8 (TW) | 32 W | 4,200 lm* | 131 lm/W | 209.90 |
| 32055074 | AGGY | 620 x 620 | 4,000 K | 85° | Microprism | UGR < 19 | switchable | 32 W | 4,200 lm | 131 lm/W | 99.90 |
| 32055073 | AGGY | 620 x 620 | 3,000 K | 85° | Microprism | UGR < 19 | switchable | 32 W | 4,000 lm | 125 lm/W | 99.90 |
| 32056074 | AGGY | 620 x 620 | 4,000 K | 85° | Microprism | UGR < 19 | DALI-2 | 32 W | 4,200 lm | 131 lm/W | 119.90 |
| 32056073 | AGGY | 620 x 620 | 3,000 K | 85° | Microprism | UGR < 19 | DALI-2 | 32 W | 4,000 lm | 125 lm/W | 119.90 |
| 32057073 | AGGY | 620 x 620 | 3,000 K | 120° | Opal | UGR < 22 | switchable | 32 W | 4,200 lm | 131 lm/W | 89.90 |
| 32057074 | AGGY | 620 x 620 | 4,000 K | 120° | Opal | UGR < 22 | switchable | 32 W | 4,500 lm | 141 lm/W | 89.90 |
| 32058073 | AGGY | 620 x 620 | 3,000 K | 120° | Opal | UGR < 22 | DALI-2 | 32 W | 4,200 lm | 131 lm/W | 109.90 |
| 32058074 | AGGY | 620 x 620 | 4,000 K | 120° | Opal | UGR < 22 | DALI-2 | 32 W | 4,500 lm | 141 lm/W | 109.90 |
| 32059074 | AGGY | 620 x 620 | 2,700 K – 6,500 K | 85° | Microprism | UGR < 19 | DALI-2, DALI DT8 (TW) | 32 W | 4,200 lm* | 131 lm/W | 199.90 |



60 pcs / pallet *at 4,000 K

tunable
(TW) = Tunable White

These items are subject to discount group 2.

Example of multi-lumen setting for 4,000 K version with microprismatic cover:

| Series | Stage 1 (800 mA) | | | Stage 2 (900 mA) | | | Stage 3 (950 mA) | | | Stage 4 (1050 mA) | | |
|--------------|------------------|------------------|-------------------|------------------|------------------|-------------------|------------------|------------------|-------------------|-------------------|------------------|-------------------|
| | Light power (lm) | System power (W) | System efficiency | Light power (lm) | System power (W) | System efficiency | Light power (lm) | System power (W) | System efficiency | Light power (lm) | System power (W) | System efficiency |
| PINOS / AGGY | 3100 | 25 | 124 | 3500 | 28 | 125 | 3600 | 29 | 124 | 4200 | 32 | 131 |
| OREN | 3600 | 29 | 124 | 4100 | 33 | 124 | 4300 | 35 | 123 | 4700 | 38 | 124 |
| TIMOR | 4350 | 35 | 124 | 4850 | 39 | 124 | 5080 | 41 | 124 | 5600 | 45 | 124 |
| CEBU | 4350 | 35 | 124 | 4850 | 39 | 124 | 5080 | 41 | 124 | 5600 | 45 | 124 |



The different stages are set using DIP switches on the converter.

Standard setting: Stage 4.



Simple installation. Flexible and time-saving.

The installation of the luminaires is child's play with our innovative LED panels. Thanks to the simple plug connection and tool-free cabling, you save time and effort.

Depending on requirements, you can choose between installation without a frame, with an installation frame or with a mounting frame – so you always stay flexible.

Direct installation without installation frame.

In so-called grid ceilings you can insert the individual panels directly without additional frames. This saves time and also enables a virtually seamless ceiling appearance.

Installation with installation frame.

Using installation frames, LED panels can be inserted into an appropriate ceiling cut-out and, as a result, can be visually integrated into a room without influencing the overall appearance of the room in terms of design.

Installation with mounting frame.

A mounting frame makes it possible to mount the panel directly below the ceiling or on the wall. The big advantage of this frame is the possibility to stow all attached parts such as the power supply unit out of sight in the frame.



**Set incl. converter for 230 V mains voltage**

Lamp: LED, colour: white (RAL 9016),
input voltage: 220 – 240 V AC, 220-240 V DC, 50 – 60 Hz,
colour rendering: CRI > 80, SDCM < 3, material: aluminium / PMMA

Switchable: Multi-lumen operating unit with through-wiring
DALI-2: Multi-lumen operating unit with through-wiring
DALI (DT8): Multi-lumen operating unit with through-wiring

Service life: L80/B10, > 50,000 hrs. (ta: +25 °C)

| Article no. | Series name | Dimensions in mm | Colour temp. | Beam angle | Cover | UGR | Control | Power output | Luminous flux | System efficiency | Price in € |
|-------------|-------------|------------------|-------------------|------------|------------|----------|-----------------------|--------------|---------------|-------------------|------------|
| 32060073 | OREN | 1,245 x 308 | 3,000 K | 85° | Microprism | UGR < 19 | switchable | 38 W | 4,500 lm | 120 lm/W | 139.90 |
| 32060074 | OREN | 1,245 x 308 | 4,000 K | 85° | Microprism | UGR < 19 | switchable | 38 W | 4,700 lm | 124 lm/W | 139.90 |
| 32061073 | OREN | 1,245 x 308 | 3,000 K | 85° | Microprism | UGR < 19 | DALI-2 | 38 W | 4,500 lm | 120 lm/W | 179.90 |
| 32061074 | OREN | 1,245 x 308 | 4,000 K | 85° | Microprism | UGR < 19 | DALI-2 | 38 W | 4,700 lm | 124 lm/W | 179.90 |
| 32062073 | OREN | 1,245 x 308 | 3,000 K | 120° | Opal | UGR < 22 | switchable | 38 W | 4,700 lm | 124 lm/W | 134.90 |
| 32062074 | OREN | 1,245 x 308 | 4,000 K | 120° | Opal | UGR < 22 | switchable | 38 W | 4,900 lm | 129 lm/W | 134.90 |
| 32063073 | OREN | 1,245 x 308 | 3,000 K | 120° | Opal | UGR < 22 | DALI-2 | 38 W | 4,700 lm | 124 lm/W | 169.90 |
| 32063074 | OREN | 1,245 x 308 | 4,000 K | 120° | Opal | UGR < 22 | DALI-2 | 38 W | 4,900 lm | 129 lm/W | 169.90 |
| 32064074 | OREN | 1,245 x 308 | 2,700 K – 6,500 K | 85° | Microprism | UGR < 19 | DALI-2, DALI DT8 (TW) | 38 W | 4,700 lm* | 124 lm/W | 249.90 |
| 32065073 | TIMOR | 1,495 x 295 | 3,000 K | 85° | Microprism | UGR < 19 | switchable | 45 W | 5,400 lm | 120 lm/W | 179.90 |
| 32065074 | TIMOR | 1,495 x 295 | 4,000 K | 85° | Microprism | UGR < 19 | switchable | 45 W | 5,600 lm | 124 lm/W | 179.90 |
| 32066073 | TIMOR | 1,495 x 295 | 3,000 K | 85° | Microprism | UGR < 19 | DALI-2 | 45 W | 5,400 lm | 120 lm/W | 219.90 |
| 32066074 | TIMOR | 1,495 x 295 | 4,000 K | 85° | Microprism | UGR < 19 | DALI-2 | 45 W | 5,600 lm | 124 lm/W | 219.90 |
| 32067073 | TIMOR | 1,495 x 295 | 3,000 K | 120° | Opal | UGR < 22 | switchable | 45 W | 5,600 lm | 124 lm/W | 174.90 |
| 32067074 | TIMOR | 1,495 x 295 | 4,000 K | 120° | Opal | UGR < 22 | switchable | 45 W | 5,800 lm | 129 lm/W | 174.90 |
| 32068073 | TIMOR | 1,495 x 295 | 3,000 K | 85° | Opal | UGR < 22 | DALI-2 | 45 W | 5,600 lm | 124 lm/W | 209.90 |
| 32068074 | TIMOR | 1,495 x 295 | 4,000 K | 85° | Opal | UGR < 22 | DALI-2 | 45 W | 5,800 lm | 129 lm/W | 209.90 |
| 32069074 | TIMOR | 1,495 x 295 | 2,700 K – 6,500 K | 85° | Microprism | UGR < 19 | DALI-2, DALI DT8 (TW) | 45 W | 5,600 lm* | 124 lm/W | 299.90 |
| 32070073 | CEBU | 1,545 x 308 | 3,000 K | 85° | Microprism | UGR < 19 | switchable | 45 W | 5,400 lm | 120 lm/W | 199.90 |
| 32070074 | CEBU | 1,545 x 308 | 4,000 K | 85° | Microprism | UGR < 19 | switchable | 45 W | 5,600 lm | 124 lm/W | 199.90 |
| 32071073 | CEBU | 1,545 x 308 | 3,000 K | 85° | Microprism | UGR < 19 | DALI-2 | 45 W | 5,400 lm | 120 lm/W | 239.90 |
| 32071074 | CEBU | 1,545 x 308 | 4,000 K | 85° | Microprism | UGR < 19 | DALI-2 | 45 W | 5,600 lm | 124 lm/W | 239.90 |
| 32072073 | CEBU | 1,545 x 308 | 3,000 K | 120° | Opal | UGR < 22 | switchable | 45 W | 5,600 lm | 124 lm/W | 195.90 |
| 32072074 | CEBU | 1,545 x 308 | 4,000 K | 120° | Opal | UGR < 22 | switchable | 45 W | 5,800 lm | 129 lm/W | 195.90 |
| 32073073 | CEBU | 1,545 x 308 | 3,000 K | 85° | Opal | UGR < 22 | DALI-2 | 45 W | 5,600 lm | 124 lm/W | 229.90 |
| 32073074 | CEBU | 1,545 x 308 | 4,000 K | 85° | Opal | UGR < 22 | DALI-2 | 45 W | 5,800 lm | 129 lm/W | 229.90 |
| 32074074 | CEBU | 1,545 x 308 | 2,700 K – 6,500 K | 85° | Microprism | UGR < 19 | DALI-2, DALI DT8 (TW) | 45 W | 5,600 lm* | 124 lm/W | 329.90 |



60 pcs / pallet *at 4,000 K

(TW) = Tunable White WHITE

These items are subject to discount group 2.

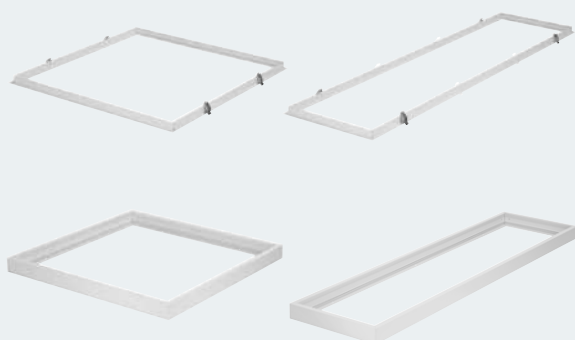
**Installation with cable suspension**

With the appropriate cable suspension, the LED panel can be used as a pendant luminaire.



| Article no. | Material | Dimensions in mm | To fit | Price in € |
|---|---|------------------|---------------------|------------|
| Installation frame white (RAL 9016) | | | | |
| 81032050 | aluminium / plastic | 655 x 655 x 30 | PINOS | 43.00 |
| 81032055 | aluminium / plastic | 680 x 680 x 30 | AGGY | 43.00 |
| 81032063 | aluminium / steel | 1,303 x 366 x 30 | OREN | 47.50 |
| 81032066 | aluminium / steel | 1,553 x 353 x 30 | TIMOR | 58.00 |
| 81032071 | aluminium / steel | 1,625 x 388 x 30 | CEBU | 59.00 |
| Mounting frame white (RAL 9016) | | | | |
| 81032051 | aluminium / plastic | 620 x 620 x 50 | PINOS | 39.00 |
| 81032056 | aluminium / plastic | 640 x 640 x 50 | AGGY | 39.00 |
| 81032064 | aluminium / steel | 1,265 x 328 x 50 | OREN | 45.00 |
| 81032067 | aluminium / steel | 1,515 x 295 x 50 | TIMOR | 55.50 |
| 81032072 | aluminium / steel | 1,564 x 327 x 50 | CEBU | 56.50 |
| Y-cable suspension universal 2 m | | | | |
| 81032068 | steel (set consisting of 2 suspensions) | | PINOS / AGGY | 15.00 |
| 81032069 | steel (set consisting of 2 suspensions) | | OREN / TIMOR / CEBU | 15.00 |
| Installation springs, set of 4 for LED panel incl. bracket | | | | |
| 00532900 | steel | | For all versions | 12.00 |

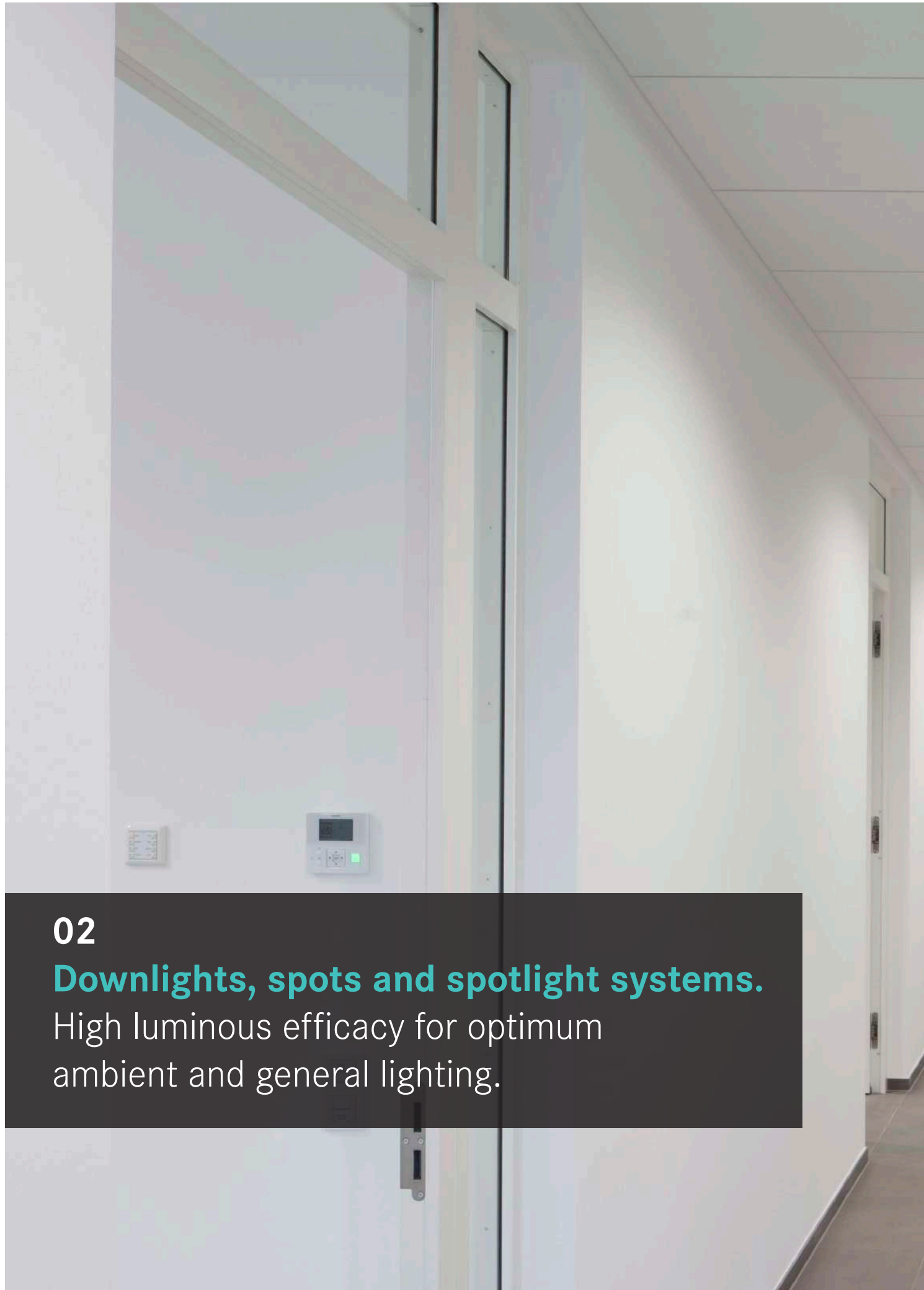

02

Downlights, spots and spotlight systems.

High luminous efficacy for optimum ambient and general lighting.



LED LIGHTING
FUNDING

BEG

Now new as
surface-mounted
version
in 4 sizes.

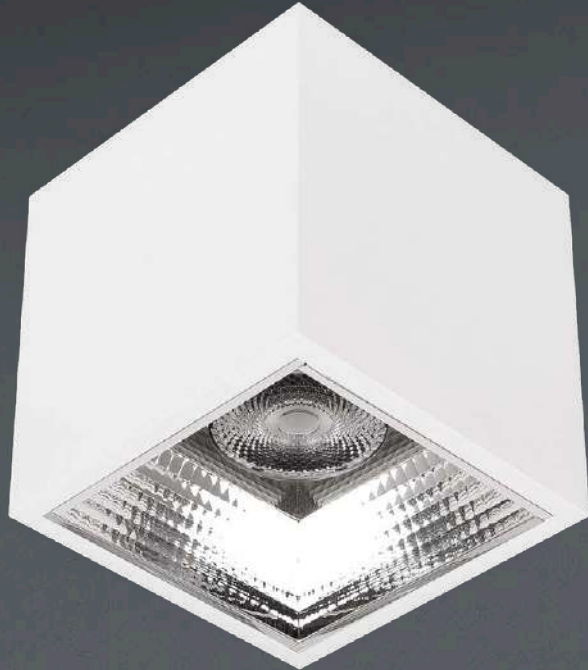

Effective lens and reflector technology for high efficiency and luminous efficacy.

APOLLO.

LED downlights.

The downlight family for homogeneous illumination through to setting precise accents.

Thanks to the wide variety of models and shapes, APOLLO can fulfil various lighting tasks. From homogeneous illumination to setting precise accents. In combination with its formal restraint, APOLLO is a perfect lighting tool for electricians, designers and planners. The possible applications are endless: Whether reception or corridor, office, conference room, shop or museum – the luminaires create the right lighting effect in any environment, fulfilling all standards and ensuring high system efficiency.

Product advantages:

- 5-year Brumberg light guarantee.
- High luminaire efficiency.
- High luminous efficacy: up to 134 lm / Watt.
- BEG LED lighting funding.
- UGR < 19 = compatible with VDU/computer workstations.
- COB-LED for long service lives.
- Effective lens and reflector technology for high efficiency and luminous efficacy.
- Two versions (round and square) in four surface-mounted and five recessed sizes.

Quick configuration table (for high-gloss reflector):

| | | switchable | | | | | | | | DALI-2 dimmable |
|-----------------------|--------|------------|-----------------|-----------------|----------------|----------------|--------------|---------|---------|-----------------|
| | | Recessed | Surface-mounted | Housing colour | | | Colour temp. | | | |
| | | | | Textured silver | Textured white | Textured black | 3,000 K | 3,500 K | 4,000 K | |
| Micro 7 W | round | 40611 | 42611 | 16 | 17 | 18 | 3 | 5 | 4 | DA |
| | square | 40641 | 42641 | 16 | 17 | 18 | 3 | 5 | 4 | DA |
| Mini 10.5 W | round | 40612 | 42612 | 16 | 17 | 18 | 3 | 5 | 4 | DA |
| | square | 40642 | 42642 | 16 | 17 | 18 | 3 | 5 | 4 | DA |
| Midi 14.5 W | round | 40613 | 42613 | 16 | 17 | 18 | 3 | 5 | 4 | DA |
| | square | 40643 | 42643 | 16 | 17 | 18 | 3 | 5 | 4 | DA |
| Maxi 20.5 W | round | 40614 | 42614 | 16 | 17 | 18 | 3 | 5 | 4 | DA |
| | square | 40644 | 42644 | 16 | 17 | 18 | 3 | 5 | 4 | DA |
| Mega 24.5 W | round | 40615 | | 16 | 17 | 18 | 3 | 5 | 4 | DA |
| | square | 40645 | | 16 | 17 | 18 | 3 | 5 | 4 | DA |

1

2

3

4

Example: Micro size, square version in textured white with 3,500 K = art. no.: 40641175
The previous selection in DALI-2 dimmable = art. no.: 40641175DA

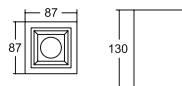
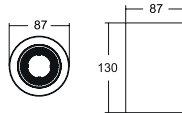

54%
Energy saving*

APOLLO MICRO LED surface-mounted downlight, reflector silver high-gloss

NEW

Lamp: LED, colour rendering: CRI > 90, glare rating: UGR < 19, power: 7 W, beam angle: Wide Flood (50°-60°), material: aluminium / plastic, incl. converter for connection to 230 V mains supply, reflector silver high-gloss

Service life:

L80/B10, 50,000 hrs. (ta: +25 °C)

42611...

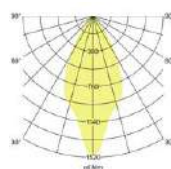

42641...

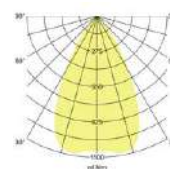

LED LIGHTING FUNDING

BEG

| Article no. textured silver | Article no. textured white | Article no. textured black | Beam angle | Shape | Colour temp. | Luminous flux | Colour rendering | Control | System efficiency | Price in € |
|-----------------------------|----------------------------|----------------------------|------------|--------|--------------|---------------|------------------|------------|-------------------|------------|
| 42611163 | 42611173 | 42611183 | 55° | round | 3,000 K | 893 lm | CRI > 90 | switchable | 128 lm/W | 159.90 |
| 42611165 | 42611175 | 42611185 | 55° | round | 3,500 K | 873 lm | CRI > 90 | switchable | 125 lm/W | 159.90 |
| 42611164 | 42611174 | 42611184 | 55° | round | 4,000 K | 873 lm | CRI > 90 | switchable | 125 lm/W | 159.90 |
| 42611163DA | 42611173DA | 42611183DA | 55° | round | 3,000 K | 893 lm | CRI > 90 | DALI-2 | 128 lm/W | 219.90 |
| 42611165DA | 42611175DA | 42611185DA | 55° | round | 3,500 K | 873 lm | CRI > 90 | DALI-2 | 125 lm/W | 219.90 |
| 42611164DA | 42611174DA | 42611184DA | 55° | round | 4,000 K | 873 lm | CRI > 90 | DALI-2 | 125 lm/W | 219.90 |
| 42641163 | 42641173 | 42641183 | 55° | square | 3,000 K | 893 lm | CRI > 90 | switchable | 128 lm/W | 159.90 |
| 42641165 | 42641175 | 42641185 | 55° | square | 3,500 K | 873 lm | CRI > 90 | switchable | 125 lm/W | 159.90 |
| 42641164 | 42641174 | 42641184 | 55° | square | 4,000 K | 873 lm | CRI > 90 | switchable | 125 lm/W | 159.90 |
| 42641163DA | 42641173DA | 42641183DA | 55° | square | 3,000 K | 893 lm | CRI > 90 | DALI-2 | 128 lm/W | 219.90 |
| 42641165DA | 42641175DA | 42641185DA | 55° | square | 3,500 K | 873 lm | CRI > 90 | DALI-2 | 125 lm/W | 219.90 |
| 42641164DA | 42641174DA | 42641184DA | 55° | square | 4,000 K | 873 lm | CRI > 90 | DALI-2 | 125 lm/W | 219.90 |



These items are subject to discount group 1.

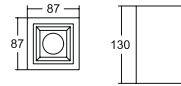
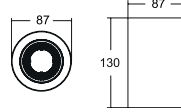

54%
Energy saving*

APOLLO MICRO LED surface-mounted downlight, reflector silver faceted

NEW

Lamp: LED, colour rendering: CRI > 90, glare rating: UGR < 19, power: 7 W, beam angle: Wide Flood (50°-60°), material: aluminium / plastic, incl. converter for connection to 230 V mains supply, reflector silver faceted

Service life:

L80/B10, 50,000 hrs. (ta: +25 °C)

43611...

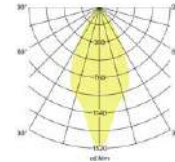

43641...

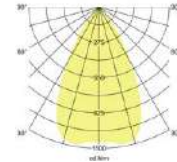

| Article no. textured silver | Article no. textured white | Article no. textured black | Beam angle | Shape | Colour temp. | Luminous flux | Colour rendering | Control | System efficiency | Price in € |
|-----------------------------|----------------------------|----------------------------|------------|--------|--------------|---------------|------------------|------------|-------------------|------------|
| 43611163 | 43611173 | 43611183 | 55° | round | 3,000 K | 893 lm | CRI>90 | switchable | 128 lm/W | 159.90 |
| 43611165 | 43611175 | 43611185 | 55° | round | 3,500 K | 873 lm | CRI>90 | switchable | 125 lm/W | 159.90 |
| 43611164 | 43611174 | 43611184 | 55° | round | 4,000 K | 873 lm | CRI>90 | switchable | 125 lm/W | 159.90 |
| 43611163DA | 43611173DA | 43611183DA | 55° | round | 3,000 K | 893 lm | CRI>90 | DALI-2 | 128 lm/W | 219.90 |
| 43611165DA | 43611175DA | 43611185DA | 55° | round | 3,500 K | 873 lm | CRI>90 | DALI-2 | 125 lm/W | 219.90 |
| 43611164DA | 43611174DA | 43611184DA | 55° | round | 4,000 K | 873 lm | CRI>90 | DALI-2 | 125 lm/W | 219.90 |
| 43641163 | 43641173 | 43641183 | 55° | square | 3,000 K | 893 lm | CRI>90 | switchable | 128 lm/W | 159.90 |
| 43641165 | 43641175 | 43641185 | 55° | square | 3,500 K | 873 lm | CRI>90 | switchable | 125 lm/W | 159.90 |
| 43641164 | 43641174 | 43641184 | 55° | square | 4,000 K | 873 lm | CRI>90 | switchable | 125 lm/W | 159.90 |
| 43641163DA | 43641173DA | 43641183DA | 55° | square | 3,000 K | 893 lm | CRI>90 | DALI-2 | 128 lm/W | 219.90 |
| 43641165DA | 43641175DA | 43641185DA | 55° | square | 3,500 K | 873 lm | CRI>90 | DALI-2 | 125 lm/W | 219.90 |
| 43641164DA | 43641174DA | 43641184DA | 55° | square | 4,000 K | 873 lm | CRI>90 | DALI-2 | 125 lm/W | 219.90 |



These items are subject to discount group 1.

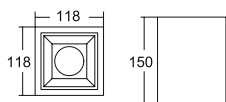
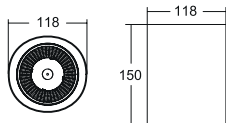

APOLLO MINI LED surface-mounted downlight, reflector silver high-gloss

NEW

Lamp: LED, colour rendering: CRI > 90, glare rating: UGR < 19, power: 10.5 W, beam angle: Wide Flood (50°-60°), material: aluminium / plastic, incl. converter for connection to 230 V mains supply, reflector silver high-gloss

Service life:

L80/B10, 50,000 hrs. (ta: +25 °C)

42612...

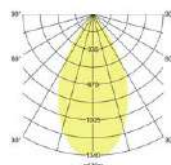

42642...

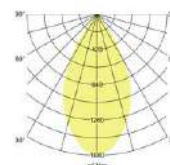

| Article no. textured silver | Article no. textured white | Article no. textured black | Beam angle | Shape | Colour temp. | Luminous flux | Colour rendering | Control | System efficiency | Price in € |
|-----------------------------|----------------------------|----------------------------|------------|--------|--------------|---------------|------------------|------------|-------------------|------------|
| 42612163 | 42612173 | 42612183 | 55° | round | 3,000 K | 1,408 lm | CRI > 90 | switchable | 134 lm/W | 190.90 |
| 42612165 | 42612175 | 42612185 | 55° | round | 3,500 K | 1,391 lm | CRI > 90 | switchable | 132 lm/W | 190.90 |
| 42612164 | 42612174 | 42612184 | 55° | round | 4,000 K | 1,385 lm | CRI > 90 | switchable | 132 lm/W | 190.90 |
| 42612163DA | 42612173DA | 42612183DA | 55° | round | 3,000 K | 1,408 lm | CRI > 90 | DALI-2 | 134 lm/W | 250.90 |
| 42612165DA | 42612175DA | 42612185DA | 55° | round | 3,500 K | 1,391 lm | CRI > 90 | DALI-2 | 132 lm/W | 250.90 |
| 42612164DA | 42612174DA | 42612184DA | 55° | round | 4,000 K | 1,385 lm | CRI > 90 | DALI-2 | 132 lm/W | 250.90 |
| 42642163 | 42642173 | 42642183 | 55° | square | 3,000 K | 1,408 lm | CRI > 90 | switchable | 134 lm/W | 190.90 |
| 42642165 | 42642175 | 42642185 | 55° | square | 3,500 K | 1,391 lm | CRI > 90 | switchable | 132 lm/W | 190.90 |
| 42642164 | 42642174 | 42642184 | 55° | square | 4,000 K | 1,385 lm | CRI > 90 | switchable | 132 lm/W | 190.90 |
| 42642163DA | 42642173DA | 42642183DA | 55° | square | 3,000 K | 1,408 lm | CRI > 90 | DALI-2 | 134 lm/W | 250.90 |
| 42642165DA | 42642175DA | 42642185DA | 55° | square | 3,500 K | 1,391 lm | CRI > 90 | DALI-2 | 132 lm/W | 250.90 |
| 42642164DA | 42642174DA | 42642184DA | 55° | square | 4,000 K | 1,385 lm | CRI > 90 | DALI-2 | 132 lm/W | 250.90 |



These items are subject to discount group 1.

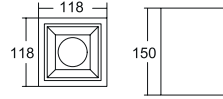
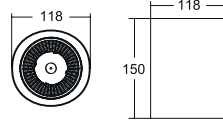

52%
Energy saving*

APOLLO MINI LED surface-mounted downlight, reflector silver faceted

NEW

Lamp: LED, colour rendering: CRI > 90, glare rating: UGR < 19, power: 10.5 W, beam angle: Wide Flood (50°-60°), material: aluminium / plastic, incl. converter for connection to 230 V mains supply, reflector silver faceted

Service life:
L80/B10, 50,000 hrs. (ta: +25 °C)

43612...

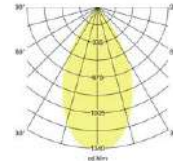

43642...

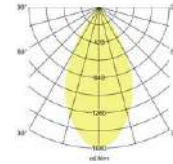

| Article no. textured silver | Article no. textured white | Article no. textured black | Beam angle | Shape | Colour temp. | Luminous flux | Colour rendering | Control | System efficiency | Price in € |
|-----------------------------|----------------------------|----------------------------|------------|--------|--------------|---------------|------------------|------------|-------------------|------------|
| 43612163 | 43612173 | 43612183 | 55° | round | 3,000 K | 1,408 lm | CRI>90 | switchable | 134 lm/W | 190.90 |
| 43612165 | 43612175 | 43612185 | 55° | round | 3,500 K | 1,391 lm | CRI>90 | switchable | 132 lm/W | 190.90 |
| 43612164 | 43612174 | 43612184 | 55° | round | 4,000 K | 1,385 lm | CRI>90 | switchable | 132 lm/W | 190.90 |
| 43612163DA | 43612173DA | 43612183DA | 55° | round | 3,000 K | 1,408 lm | CRI>90 | DALI-2 | 134 lm/W | 250.90 |
| 43612165DA | 43612175DA | 43612185DA | 55° | round | 3,500 K | 1,391 lm | CRI>90 | DALI-2 | 132 lm/W | 250.90 |
| 43612164DA | 43612174DA | 43612184DA | 55° | round | 4,000 K | 1,385 lm | CRI>90 | DALI-2 | 132 lm/W | 250.90 |
| 43642163 | 43642173 | 43642183 | 55° | square | 3,000 K | 1,408 lm | CRI>90 | switchable | 134 lm/W | 190.90 |
| 43642165 | 43642175 | 43642185 | 55° | square | 3,500 K | 1,391 lm | CRI>90 | switchable | 132 lm/W | 190.90 |
| 43642164 | 43642174 | 43642184 | 55° | square | 4,000 K | 1,385 lm | CRI>90 | switchable | 132 lm/W | 190.90 |
| 43642163DA | 43642173DA | 43642183DA | 55° | square | 3,000 K | 1,408 lm | CRI>90 | DALI-2 | 134 lm/W | 250.90 |
| 43642165DA | 43642175DA | 43642185DA | 55° | square | 3,500 K | 1,391 lm | CRI>90 | DALI-2 | 132 lm/W | 250.90 |
| 43642164DA | 43642174DA | 43642184DA | 55° | square | 4,000 K | 1,385 lm | CRI>90 | DALI-2 | 132 lm/W | 250.90 |



These items are subject to discount group 1.

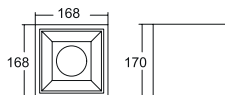
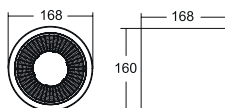

APOLLO MIDI LED surface-mounted downlight, reflector silver high-gloss

NEW

Lamp: LED, colour rendering: CRI > 90, glare rating: UGR < 19, power: 14.5 W, beam angle: Wide Flood (50°-60°), material: aluminium / plastic, incl. converter for connection to 230 V mains supply, reflector silver high-gloss

Service life:

L80/B10, 50,000 hrs. (ta: +25 °C)

42613...

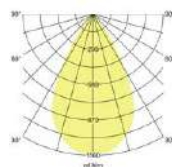

42643...

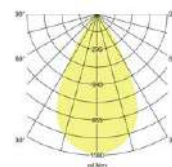

LED LIGHTING FUNDING

BEG

| Article no. textured silver | Article no. textured white | Article no. textured black | Beam angle | Shape | Colour temp. | Luminous flux | Colour rendering | Control | System efficiency | Price in € |
|-----------------------------|----------------------------|----------------------------|------------|--------|--------------|---------------|------------------|------------|-------------------|------------|
| 42613163 | 42613173 | 42613183 | 55° | round | 3,000 K | 1,869 lm | CRI > 90 | switchable | 129 lm/W | 245.90 |
| 42613165 | 42613175 | 42613185 | 55° | round | 3,500 K | 1,916 lm | CRI > 90 | switchable | 132 lm/W | 245.90 |
| 42613164 | 42613174 | 42613184 | 55° | round | 4,000 K | 1,915 lm | CRI > 90 | switchable | 132 lm/W | 245.90 |
| 42613163DA | 42613173DA | 42613183DA | 55° | round | 3,000 K | 1,869 lm | CRI > 90 | DALI-2 | 129 lm/W | 305.90 |
| 42613165DA | 42613175DA | 42613185DA | 55° | round | 3,500 K | 1,916 lm | CRI > 90 | DALI-2 | 132 lm/W | 305.90 |
| 42613164DA | 42613174DA | 42613184DA | 55° | round | 4,000 K | 1,915 lm | CRI > 90 | DALI-2 | 132 lm/W | 305.90 |
| 42643163 | 42643173 | 42643183 | 55° | square | 3,000 K | 1,869 lm | CRI > 90 | switchable | 129 lm/W | 245.90 |
| 42643165 | 42643175 | 42643185 | 55° | square | 3,500 K | 1,916 lm | CRI > 90 | switchable | 132 lm/W | 245.90 |
| 42643164 | 42643174 | 42643184 | 55° | square | 4,000 K | 1,915 lm | CRI > 90 | switchable | 132 lm/W | 245.90 |
| 42643163DA | 42643173DA | 42643183DA | 55° | square | 3,000 K | 1,869 lm | CRI > 90 | DALI-2 | 129 lm/W | 305.90 |
| 42643165DA | 42643175DA | 42643185DA | 55° | square | 3,500 K | 1,916 lm | CRI > 90 | DALI-2 | 132 lm/W | 305.90 |
| 42643164DA | 42643174DA | 42643184DA | 55° | square | 4,000 K | 1,915 lm | CRI > 90 | DALI-2 | 132 lm/W | 305.90 |



These items are subject to discount group 1.

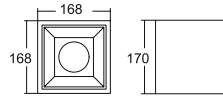
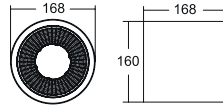

APOLLO MIDI LED surface-mounted downlight, reflector silver faceted

NEW

Lamp: LED, colour rendering: CRI > 90, glare rating: UGR < 19, power: 14.5 W, beam angle: Wide Flood (50°-60°), material: aluminium / plastic, incl. converter for connection to 230 V mains supply, reflector silver faceted

Service life:

L80/B10, 50,000 hrs. (ta: +25 °C)

43613...

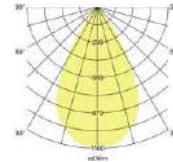

43643...

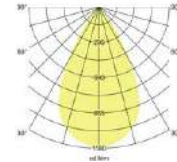

LED LIGHTING FUNDING

BEG

| Article no. textured silver | Article no. textured white | Article no. textured black | Beam angle | Shape | Colour temp. | Luminous flux | Colour rendering | Control | System efficiency | Price in € |
|-----------------------------|----------------------------|----------------------------|------------|--------|--------------|---------------|------------------|------------|-------------------|------------|
| 43613163 | 43613173 | 43613183 | 55° | round | 3,000 K | 1,869 lm | CRI>90 | switchable | 129 lm/W | 245.90 |
| 43613165 | 43613175 | 43613185 | 55° | round | 3,500 K | 1,916 lm | CRI>90 | switchable | 132 lm/W | 245.90 |
| 43613164 | 43613174 | 43613184 | 55° | round | 4,000 K | 1,915 lm | CRI>90 | switchable | 132 lm/W | 245.90 |
| 43613163DA | 43613173DA | 43613183DA | 55° | round | 3,000 K | 1,869 lm | CRI>90 | DALI-2 | 129 lm/W | 305.90 |
| 43613165DA | 43613175DA | 43613185DA | 55° | round | 3,500 K | 1,916 lm | CRI>90 | DALI-2 | 132 lm/W | 305.90 |
| 43613164DA | 43613174DA | 43613184DA | 55° | round | 4,000 K | 1,915 lm | CRI>90 | DALI-2 | 132 lm/W | 305.90 |
| 43643163 | 43643173 | 43643183 | 55° | square | 3,000 K | 1,869 lm | CRI>90 | switchable | 129 lm/W | 245.90 |
| 43643165 | 43643175 | 43643185 | 55° | square | 3,500 K | 1,916 lm | CRI>90 | switchable | 132 lm/W | 245.90 |
| 43643164 | 43643174 | 43643184 | 55° | square | 4,000 K | 1,915 lm | CRI>90 | switchable | 132 lm/W | 245.90 |
| 43643163DA | 43643173DA | 43643183DA | 55° | square | 3,000 K | 1,869 lm | CRI>90 | DALI-2 | 129 lm/W | 305.90 |
| 43643165DA | 43643175DA | 43643185DA | 55° | square | 3,500 K | 1,916 lm | CRI>90 | DALI-2 | 132 lm/W | 305.90 |
| 43643164DA | 43643174DA | 43643184DA | 55° | square | 4,000 K | 1,915 lm | CRI>90 | DALI-2 | 132 lm/W | 305.90 |



These items are subject to discount group 1.

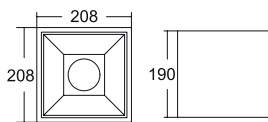
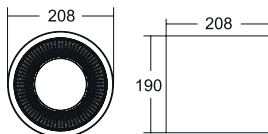

42%
Energy saving*

APOLLO MAXI LED surface-mounted downlight, reflector silver high-gloss NEW

Lamp: LED, colour rendering: CRI > 90, glare rating: UGR < 19, power: 20.5 W, beam angle: Wide Flood (50°-60°), material: aluminium / plastic, incl. converter for connection to 230 V mains supply, reflector silver high-gloss

Service life:
L80/B10, 50,000 hrs. (ta: +25 °C)

42614...

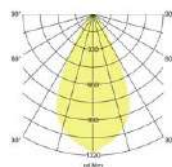

42644...

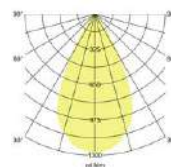

| Article no. textured silver | Article no. textured white | Article no. textured black | Beam angle | Shape | Colour temp. | Luminous flux | Colour rendering | Control | System efficiency | Price in € |
|-----------------------------|----------------------------|----------------------------|------------|--------|--------------|---------------|------------------|------------|-------------------|------------|
| 42614163 | 42614173 | 42614183 | 55° | round | 3,000 K | 2,632 lm | CRI > 90 | switchable | 128 lm/W | 299.90 |
| 42614165 | 42614175 | 42614185 | 55° | round | 3,500 K | 2,655 lm | CRI > 90 | switchable | 130 lm/W | 299.90 |
| 42614164 | 42614174 | 42614184 | 55° | round | 4,000 K | 2,618 lm | CRI > 90 | switchable | 128 lm/W | 299.90 |
| 42614163DA | 42614173DA | 42614183DA | 55° | round | 3,000 K | 2,632 lm | CRI > 90 | DALI-2 | 128 lm/W | 359.90 |
| 42614165DA | 42614175DA | 42614185DA | 55° | round | 3,500 K | 2,655 lm | CRI > 90 | DALI-2 | 130 lm/W | 359.90 |
| 42614164DA | 42614174DA | 42614184DA | 55° | round | 4,000 K | 2,618 lm | CRI > 90 | DALI-2 | 128 lm/W | 359.90 |
| 42644163 | 42644173 | 42644183 | 55° | square | 3,000 K | 2,632 lm | CRI > 90 | switchable | 128 lm/W | 299.90 |
| 42644165 | 42644175 | 42644185 | 55° | square | 3,500 K | 2,655 lm | CRI > 90 | switchable | 130 lm/W | 299.90 |
| 42644164 | 42644174 | 42644184 | 55° | square | 4,000 K | 2,618 lm | CRI > 90 | switchable | 128 lm/W | 299.90 |
| 42644163DA | 42644173DA | 42644183DA | 55° | square | 3,000 K | 2,632 lm | CRI > 90 | DALI-2 | 128 lm/W | 359.90 |
| 42644165DA | 42644175DA | 42644185DA | 55° | square | 3,500 K | 2,655 lm | CRI > 90 | DALI-2 | 130 lm/W | 359.90 |
| 42644164DA | 42644174DA | 42644184DA | 55° | square | 4,000 K | 2,618 lm | CRI > 90 | DALI-2 | 128 lm/W | 359.90 |



These items are subject to discount group 1.

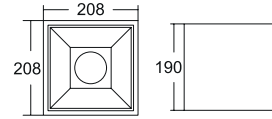
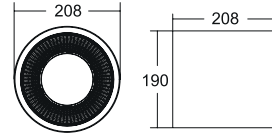

42%
Energy saving*

APOLLO MAXI LED surface-mounted downlight, reflector silver faceted NEW

Lamp: LED, colour rendering: CRI > 90, glare rating: UGR < 19, power: 20.5 W, beam angle: Wide Flood (50°-60°), material: aluminium / plastic, incl. converter for connection to 230 V mains supply, reflector silver faceted

Service life:
L80/B10, 50,000 hrs. (ta: +25 °C)

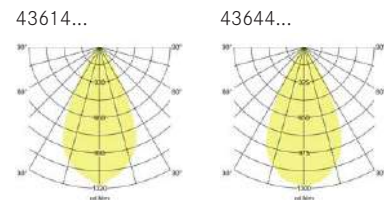

| Article no. textured silver | Article no. textured white | Article no. textured black | Beam angle | Shape | Colour temp. | Luminous flux | Colour rendering | Control | System efficiency | Price in € |
|-----------------------------|----------------------------|----------------------------|------------|--------|--------------|---------------|------------------|------------|-------------------|------------|
| 43614163 | 43614173 | 43614183 | 55° | round | 3,000 K | 2,632 lm | CRI>90 | switchable | 128 lm/W | 299.90 |
| 43614165 | 43614175 | 43614185 | 55° | round | 3,500 K | 2,655 lm | CRI>90 | switchable | 130 lm/W | 299.90 |
| 43614164 | 43614174 | 43614184 | 55° | round | 4,000 K | 2,618 lm | CRI>90 | switchable | 128 lm/W | 299.90 |
| 43614163DA | 43614173DA | 43614183DA | 55° | round | 3,000 K | 2,632 lm | CRI>90 | DALI-2 | 128 lm/W | 359.90 |
| 43614165DA | 43614175DA | 43614185DA | 55° | round | 3,500 K | 2,655 lm | CRI>90 | DALI-2 | 130 lm/W | 359.90 |
| 43614164DA | 43614174DA | 43614184DA | 55° | round | 4,000 K | 2,618 lm | CRI>90 | DALI-2 | 128 lm/W | 359.90 |
| 43644163 | 43644173 | 43644183 | 55° | square | 3,000 K | 2,632 lm | CRI>90 | switchable | 128 lm/W | 299.90 |
| 43644165 | 43644175 | 43644185 | 55° | square | 3,500 K | 2,655 lm | CRI>90 | switchable | 130 lm/W | 299.90 |
| 43644164 | 43644174 | 43644184 | 55° | square | 4,000 K | 2,618 lm | CRI>90 | switchable | 128 lm/W | 299.90 |
| 43644163DA | 43644173DA | 43644183DA | 55° | square | 3,000 K | 2,632 lm | CRI>90 | DALI-2 | 128 lm/W | 359.90 |
| 43644165DA | 43644175DA | 43644185DA | 55° | square | 3,500 K | 2,655 lm | CRI>90 | DALI-2 | 130 lm/W | 359.90 |
| 43644164DA | 43644174DA | 43644184DA | 55° | square | 4,000 K | 2,618 lm | CRI>90 | DALI-2 | 128 lm/W | 359.90 |



These items are subject to discount group 1.

Exemplary profitability calculation.

Corridor lighting in an office building.

100 existing luminaires with 1-to-1 replacement compared to APOLLO MIDI recessed downlight, 14.5 W, 4,000 K.

| Luminaires | Luminaire | Art. no.: | Number of luminaires | Service life lamp | Luminaire power in W | Gross price in € | Price in |
|--------------------|-------------------------|-----------------------|----------------------|-------------------|----------------------|------------------------------|----------|
| Luminaire LED | APOLLO MIDI | 40613174 | 100 | 50,000 | 14.5 | 199.90 | 199.90 |
| Existing luminaire | Downlight, TC-TEL 1x26W | 26W+el. ballast = 28W | 100 | 15,000 | 28 | 0.00 as already available | |

| Luminaire operation | | | | | |
|--------------------------------|------|---------------|---|--------------------------|------|
| Number of hours per day | 10 | Days per week | 6 | Operating hours per year | 3120 |
| Electricity price per kWh in € | 0.39 | | | | |

| Maintenance costs | | | Costs per lamp | Maintenance costs € |
|--------------------|-------------------------|-----------------------|----------------|---------------------|
| Luminaire LED | APOLLO MIDI | 40613174 | 0 | 0 |
| Existing luminaire | Downlight, TC-TEL 1x26W | 26W+el. ballast = 28W | 15.00 | 15.00 |

RESULTS

| Acquisition | Luminaire LED | Existing luminaire |
|--------------------------------------|---------------|--------------------|
| Acquisition costs of the system in € | 24,590.00 | 0.00 |
| Difference price LED to stock in € | 24,590.00 | |
| Difference in % | 100% | |

| System power | | | Electricity/year in kWh | Reduction in kWh | Electricity costs in €/year |
|--------------------|-------------------------|-----------------------|-------------------------|------------------|-----------------------------|
| Luminaire LED | APOLLO MIDI | 40613174 | 4,368 | 4,368 | 1,703.52 |
| Existing luminaire | Downlight, TC-TEL 1x26W | 26W+el. ballast = 28W | 8,736 | | 3,407.04 |

Electricity savings/year
1,703.52 €

| Maintenance intervals / service life lamp | | | Replacement interval existing vs. LED | Replacement costs Total operating time in € | Replacement costs per interval in € |
|---|-------------------------|-----------------------|---------------------------------------|---|-------------------------------------|
| Luminaire LED | APOLLO MIDI | 40613174 | 16.03 years | 4 years | 12,000.00 |
| Existing luminaire | Downlight, TC-TEL 1x26W | 26W+el. ballast = 28W | 4.81 years | | 3,000.00 |

Resulting amortisation period
5.23 years

| CO ₂ balance in tonnes/year | |
|--|-------|
| LED luminaire | 2.346 |
| Existing luminaires | 4.691 |

CO₂ savings/year
2.346 tonnes

CO₂ balance (according to the Federal Environment Agency) 0.537 kg/kWh



DA: 68 mm

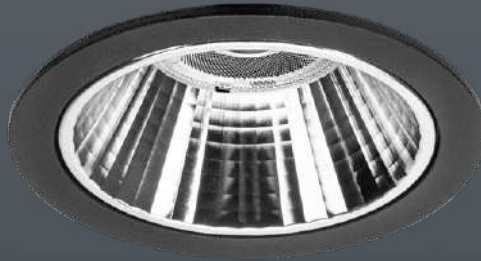

DA: 100 mm

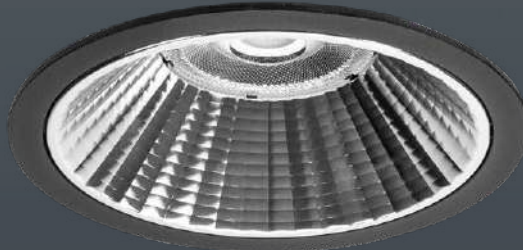

DA: 150 mm

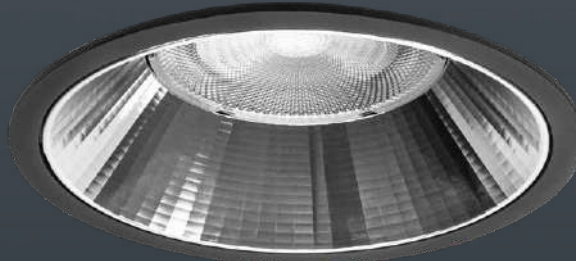

DA: 190 mm

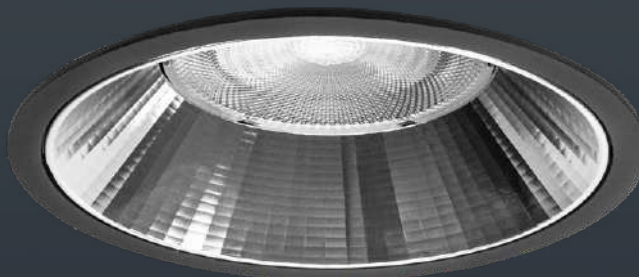

DA: 240 mm

APOLLO. LED recessed down- lights.

Energy-efficient lighting for new
and existing buildings.

3-year BrightLight guarantee after registration.

- High luminaire efficiency up to 134 lm/Watt.
- UGR < 19 = compatible with VDU/computer workstations.
- COB-LED for long service lives.
- Two shapes (round / square).
- Five sizes for all common ceiling cut-outs.
- High-gloss or faceted reflector.
- Matching reduction rings available for intermediate sizes.

Up to
134
lm/W

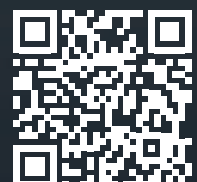

Find out more.

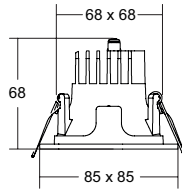
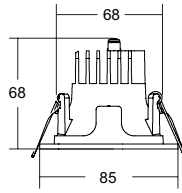

APOLLO MICRO LED recessed downlight, reflector silver high-gloss

Lamp: LED, colour rendering: CRI > 90, glare rating: UGR < 19, power: 7 W, beam angle: Wide Flood (50°-60°), material: aluminium / plastic, incl. converter for connection to 230 V mains supply, reflector silver high-gloss

Service life:
L80/B10, 50,000 hrs. (ta: +25 °C)

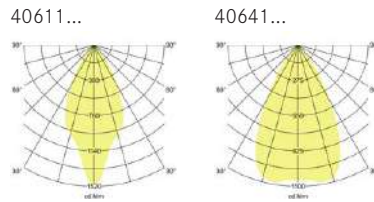

| Article no. textured silver | Article no. textured white | Article no. textured black | Beam angle | Shape | Colour temp. | Luminous flux | Colour rendering | Control | System efficiency | Price in € |
|-----------------------------|----------------------------|----------------------------|------------|--------|--------------|---------------|------------------|------------|-------------------|------------|
| 40611163 | 40611173 | 40611183 | 55° | round | 3,000 K | 893 lm | CRI > 90 | switchable | 128 lm/W | 139.90 |
| 40611165 | 40611175 | 40611185 | 55° | round | 3,500 K | 873 lm | CRI > 90 | switchable | 125 lm/W | 139.90 |
| 40611164 | 40611174 | 40611184 | 55° | round | 4,000 K | 873 lm | CRI > 90 | switchable | 125 lm/W | 139.90 |
| 40611163DA | 40611173DA | 40611183DA | 55° | round | 3,000 K | 893 lm | CRI > 90 | DALI-2 | 128 lm/W | 199.90 |
| 40611165DA | 40611175DA | 40611185DA | 55° | round | 3,500 K | 873 lm | CRI > 90 | DALI-2 | 125 lm/W | 199.90 |
| 40611164DA | 40611174DA | 40611184DA | 55° | round | 4,000 K | 873 lm | CRI > 90 | DALI-2 | 125 lm/W | 199.90 |
| 40641163 | 40641173 | 40641183 | 55° | square | 3,000 K | 893 lm | CRI > 90 | switchable | 128 lm/W | 139.90 |
| 40641165 | 40641175 | 40641185 | 55° | square | 3,500 K | 873 lm | CRI > 90 | switchable | 125 lm/W | 139.90 |
| 40641164 | 40641174 | 40641184 | 55° | square | 4,000 K | 873 lm | CRI > 90 | switchable | 125 lm/W | 139.90 |
| 40641163DA | 40641173DA | 40641183DA | 55° | square | 3,000 K | 893 lm | CRI > 90 | DALI-2 | 128 lm/W | 199.90 |
| 40641165DA | 40641175DA | 40641185DA | 55° | square | 3,500 K | 873 lm | CRI > 90 | DALI-2 | 125 lm/W | 199.90 |
| 40641164DA | 40641174DA | 40641184DA | 55° | square | 4,000 K | 873 lm | CRI > 90 | DALI-2 | 125 lm/W | 199.90 |

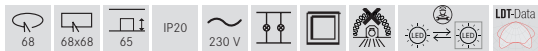

These items are subject to discount group 1.

Reducing elements for APOLLO MICRO:

Reducing ring round:

outside dia. = 150 mm, inside dia. = 68 mm, thickness 1.5 mm, with three fixing springs for the ring itself at a distance of 100 mm

| Article no. | Colour | Price in € |
|-------------|-----------------|------------|
| 81123160 | textured silver | 26.20 |
| 81123170 | textured white | 26.20 |
| 81123180 | textured black | 26.20 |

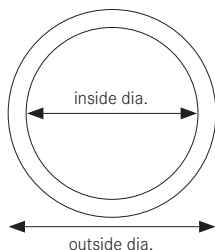

These items are subject to discount group 1.

Reducing frame square:

L x W outside = 150 mm x 150 mm, L x W inside = 68 mm x 68 mm, thickness 1.5 mm, with four fixing springs for the ring itself at 100 mm intervals

| Article no. | Colour | Price in € |
|-------------|-----------------|------------|
| 81143160 | textured silver | 29.70 |
| 81143170 | textured white | 29.70 |
| 81143180 | textured black | 29.70 |

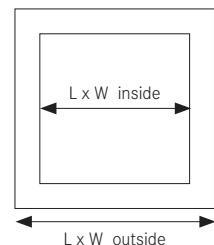

These items are subject to discount group 1.

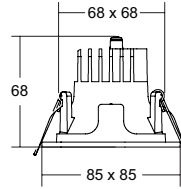
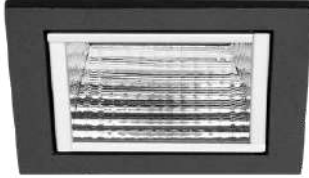
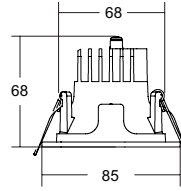

APOLLO MICRO LED recessed downlight, reflector silver faceted

Lamp: LED, colour rendering: CRI > 90, glare rating: UGR < 19, power: 7 W, beam angle: Wide Flood (50°-60°), material: aluminium / plastic, incl. converter for connection to 230 V mains supply, reflector silver faceted

Service life:

L80/B10, 50,000 hrs. (ta: +25 °C)

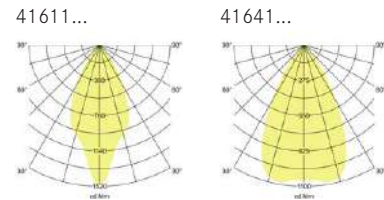

| Article no. textured silver | Article no. textured white | Article no. textured black | Beam angle | Shape | Colour temp. | Luminous flux | Colour rendering | Control | System efficiency | Price in € |
|-----------------------------|----------------------------|----------------------------|------------|--------|--------------|---------------|------------------|------------|-------------------|------------|
| 41611163 | 41611173 | 41611183 | 55° | round | 3,000 K | 893 lm | CRI > 90 | switchable | 128 lm/W | 139.90 |
| 41611165 | 41611175 | 41611185 | 55° | round | 3,500 K | 873 lm | CRI > 90 | switchable | 125 lm/W | 139.90 |
| 41611164 | 41611174 | 41611184 | 55° | round | 4,000 K | 873 lm | CRI > 90 | switchable | 125 lm/W | 139.90 |
| 41611163DA | 41611173DA | 41611183DA | 55° | round | 3,000 K | 893 lm | CRI > 90 | DALI-2 | 128 lm/W | 199.90 |
| 41611165DA | 41611175DA | 41611185DA | 55° | round | 3,500 K | 873 lm | CRI > 90 | DALI-2 | 125 lm/W | 199.90 |
| 41611164DA | 41611174DA | 41611184DA | 55° | round | 4,000 K | 873 lm | CRI > 90 | DALI-2 | 125 lm/W | 199.90 |
| 41641163 | 41641173 | 41641183 | 55° | square | 3,000 K | 893 lm | CRI > 90 | switchable | 128 lm/W | 139.90 |
| 41641165 | 41641175 | 41641185 | 55° | square | 3,500 K | 873 lm | CRI > 90 | switchable | 125 lm/W | 139.90 |
| 41641164 | 41641174 | 41641184 | 55° | square | 4,000 K | 873 lm | CRI > 90 | switchable | 125 lm/W | 139.90 |
| 41641163DA | 41641173DA | 41641183DA | 55° | square | 3,000 K | 893 lm | CRI > 90 | DALI-2 | 128 lm/W | 199.90 |
| 41641165DA | 41641175DA | 41641185DA | 55° | square | 3,500 K | 873 lm | CRI > 90 | DALI-2 | 125 lm/W | 199.90 |
| 41641164DA | 41641174DA | 41641184DA | 55° | square | 4,000 K | 873 lm | CRI > 90 | DALI-2 | 125 lm/W | 199.90 |

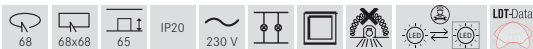

These items are subject to discount group 1.

Reducing elements for APOLLO MICRO:

Reducing ring round:

outside dia. = 150 mm, inside dia. = 68 mm, thickness 1.5 mm, with three fixing springs for the ring itself at a distance of 100 mm

| Article no. | Colour | Price in € |
|-------------|-----------------|------------|
| 81123160 | textured silver | 26.20 |
| 81123170 | textured white | 26.20 |
| 81123180 | textured black | 26.20 |

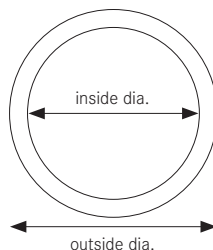

These items are subject to discount group 1.

Reducing frame square:

L x W outside = 150 mm x 150 mm, L x W inside = 68 mm x 68 mm, thickness 1.5 mm, with four fixing springs for the ring itself at 100 mm intervals

| Article no. | Colour | Price in € |
|-------------|-----------------|------------|
| 81143160 | textured silver | 29.70 |
| 81143170 | textured white | 29.70 |
| 81143180 | textured black | 29.70 |

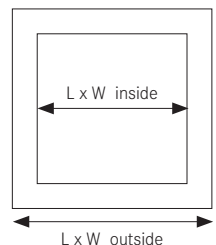

These items are subject to discount group 1.

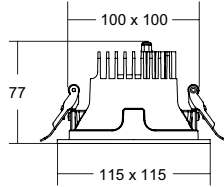
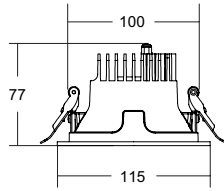

APOLLO MINI LED recessed downlight, reflector silver high-gloss

Lamp: LED, colour rendering: CRI > 90, glare rating: UGR < 19, power: 10.5 W, beam angle: Wide Flood (50°-60°), material: aluminium / plastic, incl. converter for connection to 230 V mains supply, reflector silver high-gloss

Service life:

L80/B10, 50,000 hrs. (ta: +25 °C)

40612...

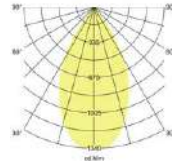

40642...

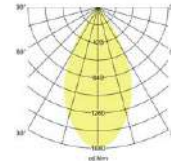

| Article no. textured silver | Article no. textured white | Article no. textured black | Beam angle | Shape | Colour temp. | Luminous flux | Colour rendering | Control | System efficiency | Price in € |
|-----------------------------|----------------------------|----------------------------|------------|--------|--------------|---------------|------------------|------------|-------------------|------------|
| 40612163 | 40612173 | 40612183 | 55° | round | 3,000 K | 1,408 lm | CRI > 90 | switchable | 134 lm/W | 169.90 |
| 40612165 | 40612175 | 40612185 | 55° | round | 3,500 K | 1,391 lm | CRI > 90 | switchable | 132 lm/W | 169.90 |
| 40612164 | 40612174 | 40612184 | 55° | round | 4,000 K | 1,385 lm | CRI > 90 | switchable | 132 lm/W | 169.90 |
| 40612163DA | 40612173DA | 40612183DA | 55° | round | 3,000 K | 1,408 lm | CRI > 90 | DALI-2 | 134 lm/W | 239.90 |
| 40612165DA | 40612175DA | 40612185DA | 55° | round | 3,500 K | 1,391 lm | CRI > 90 | DALI-2 | 132 lm/W | 239.90 |
| 40612164DA | 40612174DA | 40612184DA | 55° | round | 4,000 K | 1,385 lm | CRI > 90 | DALI-2 | 132 lm/W | 239.90 |
| 40642163 | 40642173 | 40642183 | 55° | square | 3,000 K | 1,408 lm | CRI > 90 | switchable | 134 lm/W | 169.90 |
| 40642165 | 40642175 | 40642185 | 55° | square | 3,500 K | 1,391 lm | CRI > 90 | switchable | 132 lm/W | 169.90 |
| 40642164 | 40642174 | 40642184 | 55° | square | 4,000 K | 1,385 lm | CRI > 90 | switchable | 132 lm/W | 169.90 |
| 40642163DA | 40642173DA | 40642183DA | 55° | square | 3,000 K | 1,408 lm | CRI > 90 | DALI-2 | 134 lm/W | 239.90 |
| 40642165DA | 40642175DA | 40642185DA | 55° | square | 3,500 K | 1,391 lm | CRI > 90 | DALI-2 | 132 lm/W | 239.90 |
| 40642164DA | 40642174DA | 40642184DA | 55° | square | 4,000 K | 1,385 lm | CRI > 90 | DALI-2 | 132 lm/W | 239.90 |

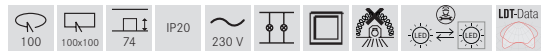

These items are subject to discount group 1.

Reducing elements for APOLLO MINI:

Reducing ring round:

outside dia. = 180 mm, inside dia. = 100 mm, thickness 1.5 mm, with three fixing springs for the ring itself at a distance of 130 mm

| Article no. | Colour | Price in € |
|-------------|-----------------|------------|
| 81124160 | textured silver | 33.10 |
| 81124170 | textured white | 33.10 |
| 81124180 | textured black | 33.10 |

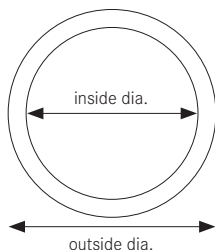

These items are subject to discount group 1.

Reducing frame square:

L x W outside = 180 mm x 180 mm, L x W inside = 100 mm x 100 mm, thickness 1.5 mm, with four fixing springs for the ring itself at 130 mm intervals

| Article no. | Colour | Price in € |
|-------------|-----------------|------------|
| 81144160 | textured silver | 36.60 |
| 81144170 | textured white | 36.60 |
| 81144180 | textured black | 36.60 |

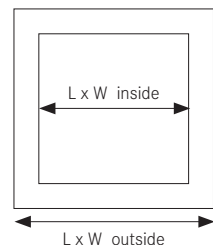

These items are subject to discount group 1.

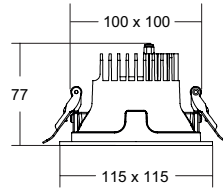
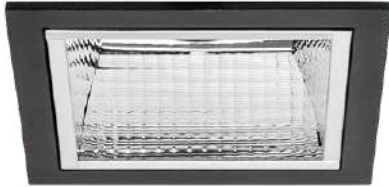
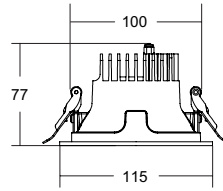

APOLLO MINI LED recessed downlight, reflector silver faceted

Lamp: LED, colour rendering: CRI > 90, glare rating: UGR < 19, power: 10.5 W, beam angle: Wide Flood (50°-60°), material: aluminium / plastic, incl. converter for connection to 230 V mains supply, reflector silver faceted

Service life:

L80/B10, 50,000 hrs. (ta: +25 °C)

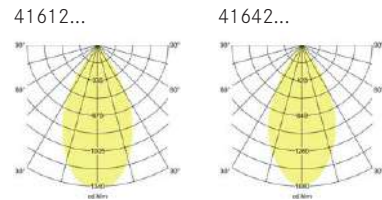

| Article no. textured silver | Article no. textured white | Article no. textured black | Beam angle | Shape | Colour temp. | Luminous flux | Colour rendering | Control | System efficiency | Price in € |
|-----------------------------|----------------------------|----------------------------|------------|--------|--------------|---------------|------------------|------------|-------------------|------------|
| 41612163 | 41612173 | 41612183 | 55° | round | 3,000 K | 1,408 lm | CRI>90 | switchable | 134 lm/W | 169.90 |
| 41612165 | 41612175 | 41612185 | 55° | round | 3,500 K | 1,391 lm | CRI>90 | switchable | 132 lm/W | 169.90 |
| 41612164 | 41612174 | 41612184 | 55° | round | 4,000 K | 1,385 lm | CRI>90 | switchable | 132 lm/W | 169.90 |
| 41612163DA | 41612173DA | 41612183DA | 55° | round | 3,000 K | 1,408 lm | CRI>90 | DALI-2 | 134 lm/W | 239.90 |
| 41612165DA | 41612175DA | 41612185DA | 55° | round | 3,500 K | 1,391 lm | CRI>90 | DALI-2 | 132 lm/W | 239.90 |
| 41612164DA | 41612174DA | 41612184DA | 55° | round | 4,000 K | 1,385 lm | CRI>90 | DALI-2 | 132 lm/W | 239.90 |
| 41642163 | 41642173 | 41642183 | 55° | square | 3,000 K | 1,408 lm | CRI>90 | switchable | 134 lm/W | 169.90 |
| 41642165 | 41642175 | 41642185 | 55° | square | 3,500 K | 1,391 lm | CRI>90 | switchable | 132 lm/W | 169.90 |
| 41642164 | 41642174 | 41642184 | 55° | square | 4,000 K | 1,385 lm | CRI>90 | switchable | 132 lm/W | 169.90 |
| 41642163DA | 41642173DA | 41642183DA | 55° | square | 3,000 K | 1,408 lm | CRI>90 | DALI-2 | 134 lm/W | 239.90 |
| 41642165DA | 41642175DA | 41642185DA | 55° | square | 3,500 K | 1,391 lm | CRI>90 | DALI-2 | 132 lm/W | 239.90 |
| 41642164DA | 41642174DA | 41642184DA | 55° | square | 4,000 K | 1,385 lm | CRI>90 | DALI-2 | 132 lm/W | 239.90 |

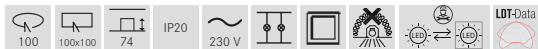

These items are subject to discount group 1.

Reducing elements for APOLLO MINI:

Reducing ring round:

outside dia. = 180 mm, inside dia. = 100 mm, thickness 1.5 mm, with three fixing springs for the ring itself at a distance of 130 mm

| Article no. | Colour | Price in € |
|-------------|-----------------|------------|
| 81124160 | textured silver | 33.10 |
| 81124170 | textured white | 33.10 |
| 81124180 | textured black | 33.10 |

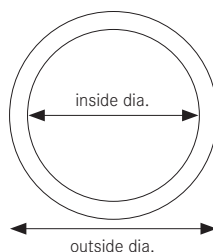

These items are subject to discount group 1.

Reducing frame square:

L x W outside = 180 mm x 180 mm, L x W inside = 100 mm x 100 mm, thickness 1.5 mm, with four fixing springs for the ring itself at 130 mm intervals

| Article no. | Colour | Price in € |
|-------------|-----------------|------------|
| 81144160 | textured silver | 36.60 |
| 81144170 | textured white | 36.60 |
| 81144180 | textured black | 36.60 |

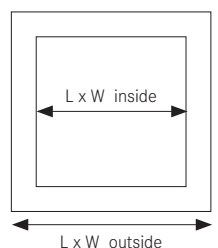

These items are subject to discount group 1.

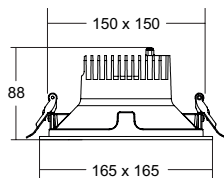
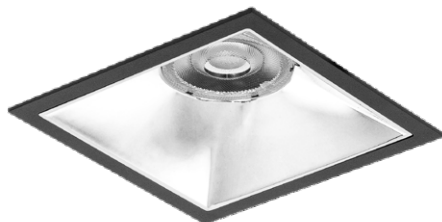
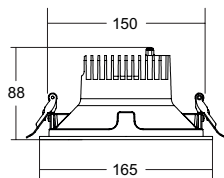

APOLLO MIDI LED recessed downlight, reflector silver high-gloss

Lamp: LED, colour rendering: CRI > 90, glare rating: UGR < 19, power: 14.5 W, beam angle: Wide Flood (50°-60°), material: aluminium / plastic, incl. converter for connection to 230 V mains supply, reflector silver high-gloss

Service life:

L80/B10, 50,000 hrs. (ta: +25 °C)

40613...

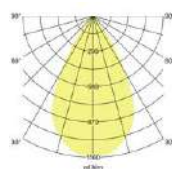

40643...

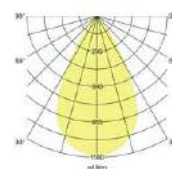

| Article no. textured silver | Article no. textured white | Article no. textured black | Beam angle | Shape | Colour temp. | Luminous flux | Colour rendering | Control | System efficiency | Price in € |
|-----------------------------|----------------------------|----------------------------|------------|--------|--------------|---------------|------------------|------------|-------------------|------------|
| 40613163 | 40613173 | 40613183 | 55° | round | 3,000 K | 1,869 lm | CRI > 90 | switchable | 129 lm/W | 199.90 |
| 40613165 | 40613175 | 40613185 | 55° | round | 3,500 K | 1,916 lm | CRI > 90 | switchable | 132 lm/W | 199.90 |
| 40613164 | 40613174 | 40613184 | 55° | round | 4,000 K | 1,915 lm | CRI > 90 | switchable | 132 lm/W | 199.90 |
| 40613163DA | 40613173DA | 40613183DA | 55° | round | 3,000 K | 1,869 lm | CRI > 90 | DALI-2 | 129 lm/W | 289.90 |
| 40613165DA | 40613175DA | 40613185DA | 55° | round | 3,500 K | 1,916 lm | CRI > 90 | DALI-2 | 132 lm/W | 289.90 |
| 40613164DA | 40613174DA | 40613184DA | 55° | round | 4,000 K | 1,915 lm | CRI > 90 | DALI-2 | 132 lm/W | 289.90 |
| 40643163 | 40643173 | 40643183 | 55° | square | 3,000 K | 1,869 lm | CRI > 90 | switchable | 129 lm/W | 199.90 |
| 40643165 | 40643175 | 40643185 | 55° | square | 3,500 K | 1,916 lm | CRI > 90 | switchable | 132 lm/W | 199.90 |
| 40643164 | 40643174 | 40643184 | 55° | square | 4,000 K | 1,915 lm | CRI > 90 | switchable | 132 lm/W | 199.90 |
| 40643163DA | 40643173DA | 40643183DA | 55° | square | 3,000 K | 1,869 lm | CRI > 90 | DALI-2 | 129 lm/W | 289.90 |
| 40643165DA | 40643175DA | 40643185DA | 55° | square | 3,500 K | 1,916 lm | CRI > 90 | DALI-2 | 132 lm/W | 289.90 |
| 40643164DA | 40643174DA | 40643184DA | 55° | square | 4,000 K | 1,915 lm | CRI > 90 | DALI-2 | 132 lm/W | 289.90 |

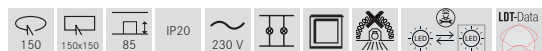

These items are subject to discount group 1.

Reducing elements for APOLLO MIDI:

Reducing ring round:

outside dia. = 230 mm, inside dia. = 150 mm, thickness 1.5 mm, with three fixing springs for the ring itself at a distance of 180 mm

| Article no. | Colour | Price in € |
|-------------|-----------------|------------|
| 81125160 | textured silver | 40.10 |
| 81125170 | textured white | 40.10 |
| 81125180 | textured black | 40.10 |

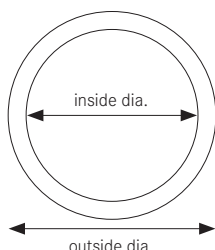

These items are subject to discount group 1.

Reducing frame square:

L x W outside = 230 mm x 230 mm, L x W inside = 150 mm x 150 mm, thickness 1.5 mm, with four fixing springs for the ring itself at 100 mm intervals

| Article no. | Colour | Price in € |
|-------------|-----------------|------------|
| 81145160 | textured silver | 43.60 |
| 81145170 | textured white | 43.60 |
| 81145180 | textured black | 43.60 |

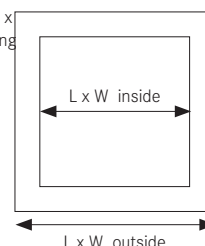

These items are subject to discount group 1.

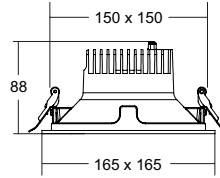
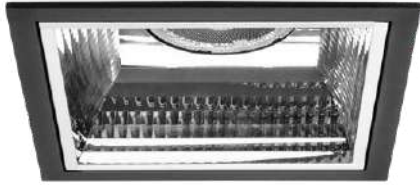
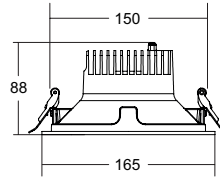

APOLLO MIDI LED recessed downlight, reflector silver faceted

Lamp: LED, colour rendering: CRI > 90, glare rating: UGR < 19, power: 14.5 W, beam angle: Wide Flood (50°-60°), material: aluminium / plastic, incl. converter for connection to 230 V mains supply, reflector silver faceted

Service life:

L80/B10, 50,000 hrs. (ta: +25 °C)

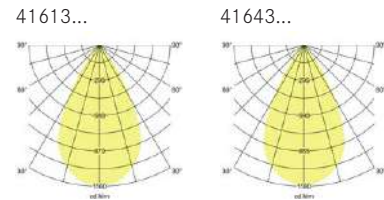

| Article no. textured silver | Article no. textured white | Article no. textured black | Beam angle | Shape | Colour temp. | Luminous flux | Colour rendering | Control | System efficiency | Price in € |
|-----------------------------|----------------------------|----------------------------|------------|--------|--------------|---------------|------------------|------------|-------------------|------------|
| 41613163 | 41613173 | 41613183 | 55° | round | 3,000 K | 1,869 lm | CRI>90 | switchable | 129 lm/W | 199.90 |
| 41613165 | 41613175 | 41613185 | 55° | round | 3,500 K | 1,916 lm | CRI>90 | switchable | 132 lm/W | 199.90 |
| 41613164 | 41613174 | 41613184 | 55° | round | 4,000 K | 1,915 lm | CRI>90 | switchable | 132 lm/W | 199.90 |
| 41613163DA | 41613173DA | 41613183DA | 55° | round | 3,000 K | 1,869 lm | CRI>90 | DALI-2 | 129 lm/W | 289.90 |
| 41613165DA | 41613175DA | 41613185DA | 55° | round | 3,500 K | 1,916 lm | CRI>90 | DALI-2 | 132 lm/W | 289.90 |
| 41613164DA | 41613174DA | 41613184DA | 55° | round | 4,000 K | 1,915 lm | CRI>90 | DALI-2 | 132 lm/W | 289.90 |
| 41643163 | 41643173 | 41643183 | 55° | square | 3,000 K | 1,869 lm | CRI>90 | switchable | 129 lm/W | 199.90 |
| 41643165 | 41643175 | 41643185 | 55° | square | 3,500 K | 1,916 lm | CRI>90 | switchable | 132 lm/W | 199.90 |
| 41643164 | 41643174 | 41643184 | 55° | square | 4,000 K | 1,915 lm | CRI>90 | switchable | 132 lm/W | 199.90 |
| 41643163DA | 41643173DA | 41643183DA | 55° | square | 3,000 K | 1,869 lm | CRI>90 | DALI-2 | 129 lm/W | 289.90 |
| 41643165DA | 41643175DA | 41643185DA | 55° | square | 3,500 K | 1,916 lm | CRI>90 | DALI-2 | 132 lm/W | 289.90 |
| 41643164DA | 41643174DA | 41643184DA | 55° | square | 4,000 K | 1,915 lm | CRI>90 | DALI-2 | 132 lm/W | 289.90 |

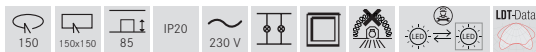

These items are subject to discount group 1.

Reducing elements for APOLLO MIDI:

Reducing ring round:

outside dia. = 230 mm, inside dia. = 150 mm, thickness 1.5 mm, with three fixing springs for the ring itself at a distance of 180 mm

| Article no. | Colour | Price in € |
|-------------|-----------------|------------|
| 81125160 | textured silver | 40.10 |
| 81125170 | textured white | 40.10 |
| 81125180 | textured black | 40.10 |

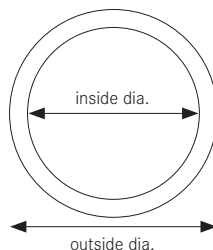

These items are subject to discount group 1.

Reducing frame square:

L x W outside = 230 mm x 230 mm, L x W inside = 150 mm x 150 mm, thickness 1.5 mm, with four fixing springs for the ring itself at 100 mm intervals

| Article no. | Colour | Price in € |
|-------------|-----------------|------------|
| 81145160 | textured silver | 43.60 |
| 81145170 | textured white | 43.60 |
| 81145180 | textured black | 43.60 |

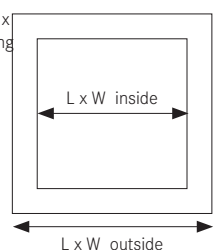

These items are subject to discount group 1.

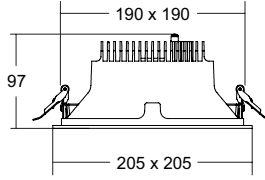
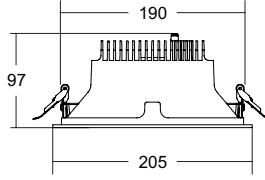

42%
Energy saving*

APOLLO MAXI LED recessed downlight, reflector silver high-gloss

Lamp: LED, colour rendering: CRI > 90, glare rating: UGR < 19, power: 20.5 W, beam angle: Wide Flood (50°-60°), material: aluminium / plastic, incl. converter for connection to 230 V mains supply, reflector silver high-gloss

Service life:

L80/B10, 50,000 hrs. (ta: +25 °C)

40614...

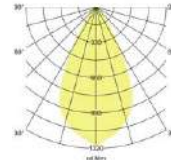

40644...

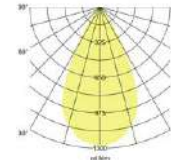

| Article no. textured silver | Article no. textured white | Article no. textured black | Beam angle | Shape | Colour temp. | Luminous flux | Colour rendering | Control | System efficiency | Price in € |
|-----------------------------|----------------------------|----------------------------|------------|--------|--------------|---------------|------------------|------------|-------------------|------------|
| 40614163 | 40614173 | 40614183 | 55° | round | 3,000 K | 2,632 lm | CRI>90 | switchable | 128 lm/W | 239.90 |
| 40614165 | 40614175 | 40614185 | 55° | round | 3,500 K | 2,655 lm | CRI>90 | switchable | 129 lm/W | 239.90 |
| 40614164 | 40614174 | 40614184 | 55° | round | 4,000 K | 2,618 lm | CRI>90 | switchable | 127 lm/W | 239.90 |
| 40614163DA | 40614173DA | 40614183DA | 55° | round | 3,000 K | 2,632 lm | CRI>90 | DALI-2 | 128 lm/W | 339.90 |
| 40614165DA | 40614175DA | 40614185DA | 55° | round | 3,500 K | 2,655 lm | CRI>90 | DALI-2 | 129 lm/W | 339.90 |
| 40614164DA | 40614174DA | 40614184DA | 55° | round | 4,000 K | 2,618 lm | CRI>90 | DALI-2 | 127 lm/W | 339.90 |
| 40644163 | 40644173 | 40644183 | 55° | square | 3,000 K | 2,632 lm | CRI>90 | switchable | 128 lm/W | 239.90 |
| 40644165 | 40644175 | 40644185 | 55° | square | 3,500 K | 2,655 lm | CRI>90 | switchable | 129 lm/W | 239.90 |
| 40644164 | 40644174 | 40644184 | 55° | square | 4,000 K | 2,618 lm | CRI>90 | switchable | 127 lm/W | 239.90 |
| 40644163DA | 40644173DA | 40644183DA | 55° | square | 3,000 K | 2,632 lm | CRI>90 | DALI-2 | 128 lm/W | 339.90 |
| 40644165DA | 40644175DA | 40644185DA | 55° | square | 3,500 K | 2,655 lm | CRI>90 | DALI-2 | 129 lm/W | 339.90 |
| 40644164DA | 40644174DA | 40644184DA | 55° | square | 4,000 K | 2,618 lm | CRI>90 | DALI-2 | 127 lm/W | 339.90 |

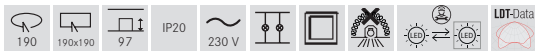

These items are subject to discount group 1.

Reducing elements for APOLLO MAXI:

Reducing ring round:

outside dia. = 270 mm, inside dia. = 190 mm, thickness 1.5 mm, with three fixing springs for the ring itself at a distance of 220 mm

| Article no. | Colour | Price in € |
|-------------|-----------------|------------|
| 81026160 | textured silver | 47.10 |
| 81026170 | textured white | 47.10 |
| 81026180 | textured black | 47.10 |

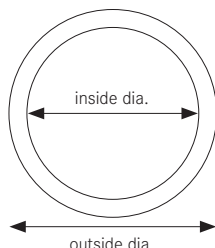

These items are subject to discount group 1.

Reducing frame square:

L x W outside = 270 mm x 270 mm, L x W inside = 190 mm x 190 mm, thickness 1.5 mm, with four fixing springs for the ring itself at 220 mm intervals

| Article no. | Colour | Price in € |
|-------------|-----------------|------------|
| 81146160 | textured silver | 50.60 |
| 81146170 | textured white | 50.60 |
| 81146180 | textured black | 50.60 |

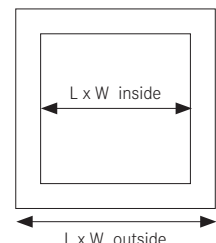

These items are subject to discount group 1.

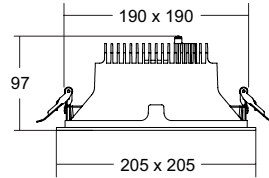
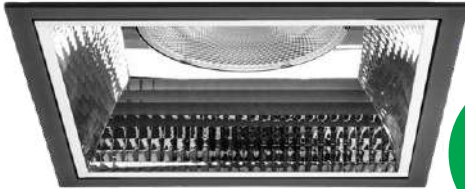
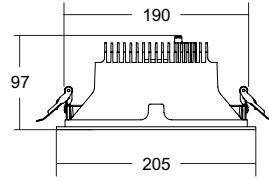

42%
Energy saving*

APOLLO MAXI LED recessed downlight, reflector silver faceted

Lamp: LED, colour rendering: CRI > 90, glare rating: UGR < 19, power: 20.5 W, beam angle: Wide Flood (50°-60°), material: aluminium / plastic, incl. converter for connection to 230 V mains supply, reflector silver faceted

Service life:

L80/B10, 50,000 hrs. (ta: +25 °C)

41614...

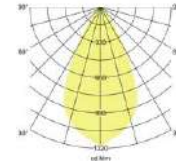

41644...

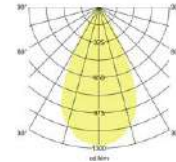

| Article no. textured silver | Article no. textured white | Article no. textured black | Beam angle | Shape | Colour temp. | Luminous flux | Colour rendering | Control | System efficiency | Price in € |
|-----------------------------|----------------------------|----------------------------|------------|--------|--------------|---------------|------------------|------------|-------------------|------------|
| 41614163 | 41614173 | 41614183 | 55° | round | 3,000 K | 2,632 lm | CRI>90 | switchable | 128 lm/W | 239.90 |
| 41614165 | 41614175 | 41614185 | 55° | round | 3,500 K | 2,655 lm | CRI>90 | switchable | 129 lm/W | 239.90 |
| 41614164 | 41614174 | 41614184 | 55° | round | 4,000 K | 2,618 lm | CRI>90 | switchable | 127 lm/W | 239.90 |
| 41614163DA | 41614173DA | 41614183DA | 55° | round | 3,000 K | 2,632 lm | CRI>90 | DALI-2 | 128 lm/W | 339.90 |
| 41614165DA | 41614175DA | 41614185DA | 55° | round | 3,500 K | 2,655 lm | CRI>90 | DALI-2 | 129 lm/W | 339.90 |
| 41614164DA | 41614174DA | 41614184DA | 55° | round | 4,000 K | 2,618 lm | CRI>90 | DALI-2 | 127 lm/W | 339.90 |
| 41644163 | 41644173 | 41644183 | 55° | square | 3,000 K | 2,632 lm | CRI>90 | switchable | 128 lm/W | 239.90 |
| 41644165 | 41644175 | 41644185 | 55° | square | 3,500 K | 2,655 lm | CRI>90 | switchable | 129 lm/W | 239.90 |
| 41644164 | 41644174 | 41644184 | 55° | square | 4,000 K | 2,618 lm | CRI>90 | switchable | 127 lm/W | 239.90 |
| 41644163DA | 41644173DA | 41644183DA | 55° | square | 3,000 K | 2,632 lm | CRI>90 | DALI-2 | 128 lm/W | 339.90 |
| 41644165DA | 41644175DA | 41644185DA | 55° | square | 3,500 K | 2,655 lm | CRI>90 | DALI-2 | 129 lm/W | 339.90 |
| 41644164DA | 41644174DA | 41644184DA | 55° | square | 4,000 K | 2,618 lm | CRI>90 | DALI-2 | 127 lm/W | 339.90 |

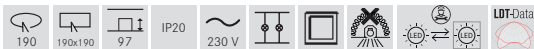

These items are subject to discount group 1.

Reducing elements for APOLLO MAXI:

Reducing ring round:

outside dia. = 270 mm, inside dia. = 190 mm, thickness 1.5 mm, with three fixing springs for the ring itself at a distance of 220 mm

| Article no. | Colour | Price in € |
|-------------|-----------------|------------|
| 81026160 | textured silver | 47.10 |
| 81026170 | textured white | 47.10 |
| 81026180 | textured black | 47.10 |

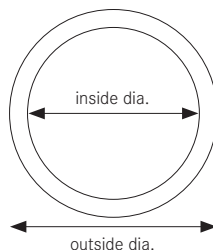

These items are subject to discount group 1.

Reducing frame square:

L x W outside = 270 mm x 270 mm, L x W inside = 190 mm x 190 mm, thickness 1.5 mm, with four fixing springs for the ring itself at 220 mm intervals

| Article no. | Colour | Price in € |
|-------------|-----------------|------------|
| 81146160 | textured silver | 50.60 |
| 81146170 | textured white | 50.60 |
| 81146180 | textured black | 50.60 |

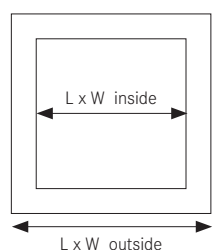

These items are subject to discount group 1.

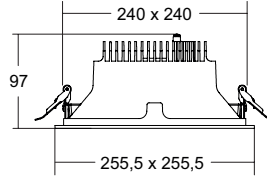
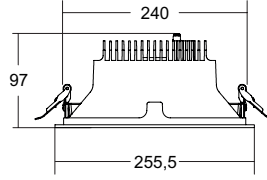

42%
Energy saving*

APOLLO MEGA LED recessed downlight, reflector silver high-gloss

Lamp: LED, colour rendering: CRI > 90, glare rating: UGR < 19, power: 24.5 W, beam angle: Wide Flood (50°-60°), material: aluminium / plastic, incl. converter for connection to 230 V mains supply, reflector silver high-gloss

Service life:
L80/B10, 50,000 hrs. (ta: +25 °C)

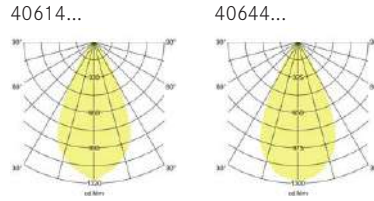

| Article no. textured silver | Article no. textured white | Article no. textured black | Beam angle | Shape | Colour temp. | Luminous flux | Colour rendering | Control | System efficiency | Price in € |
|-----------------------------|----------------------------|----------------------------|------------|--------|--------------|---------------|------------------|------------|-------------------|------------|
| 40615163 | 40615173 | 40615183 | 55° | round | 3,000 K | 3,192 lm | CRI > 90 | switchable | 130 lm/W | 299.90 |
| 40615165 | 40615175 | 40615185 | 55° | round | 3,500 K | 3,202 lm | CRI > 90 | switchable | 131 lm/W | 299.90 |
| 40615164 | 40615174 | 40615184 | 55° | round | 4,000 K | 3,194 lm | CRI > 90 | switchable | 130 lm/W | 299.90 |
| 40615163DA | 40615173DA | 40615183DA | 55° | round | 3,000 K | 3,192 lm | CRI > 90 | DALI-2 | 130 lm/W | 399.90 |
| 40615165DA | 40615175DA | 40615185DA | 55° | round | 3,500 K | 3,202 lm | CRI > 90 | DALI-2 | 131 lm/W | 399.90 |
| 40615164DA | 40615174DA | 40615184DA | 55° | round | 4,000 K | 3,194 lm | CRI > 90 | DALI-2 | 130 lm/W | 399.90 |
| 40645163 | 40645173 | 40645183 | 55° | square | 3,000 K | 3,192 lm | CRI > 90 | switchable | 130 lm/W | 299.90 |
| 40645165 | 40645175 | 40645185 | 55° | square | 3,500 K | 3,202 lm | CRI > 90 | switchable | 131 lm/W | 299.90 |
| 40645164 | 40645174 | 40645184 | 55° | square | 4,000 K | 3,194 lm | CRI > 90 | switchable | 130 lm/W | 299.90 |
| 40645163DA | 40645173DA | 40645183DA | 55° | square | 3,000 K | 3,192 lm | CRI > 90 | DALI-2 | 130 lm/W | 399.90 |
| 40645165DA | 40645175DA | 40645185DA | 55° | square | 3,500 K | 3,202 lm | CRI > 90 | DALI-2 | 131 lm/W | 399.90 |
| 40645164DA | 40645174DA | 40645184DA | 55° | square | 4,000 K | 3,194 lm | CRI > 90 | DALI-2 | 130 lm/W | 399.90 |

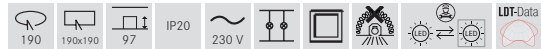

These items are subject to discount group 1.

Reducing elements for APOLLO MEGA:

Reducing ring round:

outside dia. = 320 mm, inside dia. = 240 mm, thickness 1.5 mm, with three fixing springs for the ring itself at a distance of 270 mm

| Article no. | Colour | Price in € |
|-------------|-----------------|------------|
| 81127160 | textured silver | 54.00 |
| 81127170 | textured white | 54.00 |
| 81127180 | textured black | 54.00 |

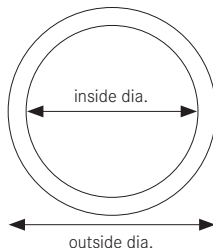

These items are subject to discount group 1.

Reducing frame square:

L x W outside = 320 mm x 320 mm, L x W inside = 240 mm x 240 mm, thickness 1.5 mm, with four fixing springs for the ring itself at 270 mm intervals

| Article no. | Colour | Price in € |
|-------------|-----------------|------------|
| 81147160 | textured silver | 57.50 |
| 81147170 | textured white | 57.50 |
| 81147180 | textured black | 57.50 |

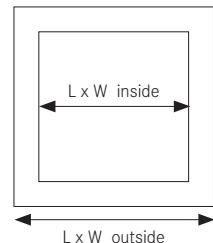

These items are subject to discount group 1.

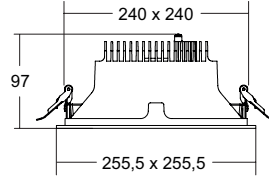
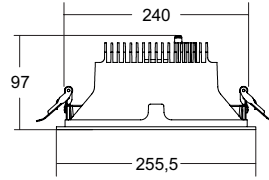

42%
Energy saving*

APOLLO MEGA LED recessed downlight, reflector silver faceted

Lamp: LED, colour rendering: CRI > 90, glare rating: UGR < 19, power: 24.5 W, beam angle: Wide Flood (50°-60°), material: aluminium / plastic, incl. converter for connection to 230 V mains supply, reflector: silver faceted

Service life:

L80/B10, 50,000 hrs. (ta: +25 °C)

41614...

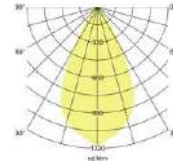

41644...

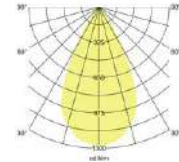

| Article no. textured silver | Article no. textured white | Article no. textured black | Beam angle | Shape | Colour temp. | Luminous flux | Colour rendering | Control | System efficiency | Price in € |
|-----------------------------|----------------------------|----------------------------|------------|--------|--------------|---------------|------------------|------------|-------------------|------------|
| 41615163 | 41615173 | 41615183 | 55° | round | 3,000 K | 3,192 lm | CRI>90 | switchable | 130 lm/W | 299.90 |
| 41615165 | 41615175 | 41615185 | 55° | round | 3,500 K | 3,202 lm | CRI>90 | switchable | 131 lm/W | 299.90 |
| 41615164 | 41615174 | 41615184 | 55° | round | 4,000 K | 3,194 lm | CRI>90 | switchable | 130 lm/W | 299.90 |
| 41615163DA | 41615173DA | 41615183DA | 55° | round | 3,000 K | 3,192 lm | CRI>90 | DALI-2 | 130 lm/W | 399.90 |
| 41615165DA | 41615175DA | 41615185DA | 55° | round | 3,500 K | 3,202 lm | CRI>90 | DALI-2 | 131 lm/W | 399.90 |
| 41615164DA | 41615174DA | 41615184DA | 55° | round | 4,000 K | 3,194 lm | CRI>90 | DALI-2 | 130 lm/W | 399.90 |
| 41645163 | 41645173 | 41645183 | 55° | square | 3,000 K | 3,192 lm | CRI>90 | switchable | 130 lm/W | 299.90 |
| 41645165 | 41645175 | 41645185 | 55° | square | 3,500 K | 3,202 lm | CRI>90 | switchable | 131 lm/W | 299.90 |
| 41645164 | 41645174 | 41645184 | 55° | square | 4,000 K | 3,194 lm | CRI>90 | switchable | 130 lm/W | 299.90 |
| 41645163DA | 41645173DA | 41645183DA | 55° | square | 3,000 K | 3,192 lm | CRI>90 | DALI-2 | 130 lm/W | 399.90 |
| 41645165DA | 41645175DA | 41645185DA | 55° | square | 3,500 K | 3,202 lm | CRI>90 | DALI-2 | 131 lm/W | 399.90 |
| 41645164DA | 41645174DA | 41645184DA | 55° | square | 4,000 K | 3,194 lm | CRI>90 | DALI-2 | 130 lm/W | 399.90 |

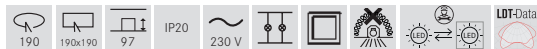

These items are subject to discount group 1.

Reducing elements for APOLLO MEGA:

Reducing ring round:

outside dia. = 320 mm, inside dia. = 240 mm, thickness 1.5 mm, with three fixing springs for the ring itself at a distance of 270 mm

| Article no. | Colour | Price in € |
|-------------|-----------------|------------|
| 81127160 | textured silver | 54.00 |
| 81127170 | textured white | 54.00 |
| 81127180 | textured black | 54.00 |

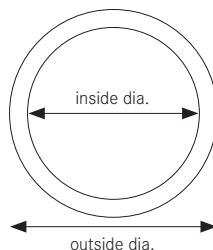

These items are subject to discount group 1.

Reducing frame square:

L x W outside = 320 mm x 320 mm, L x W inside = 240 mm x 240 mm, thickness 1.5 mm, with four fixing springs for the ring itself at 270 mm intervals

| Article no. | Colour | Price in € |
|-------------|-----------------|------------|
| 81147160 | textured silver | 57.50 |
| 81147170 | textured white | 57.50 |
| 81147180 | textured black | 57.50 |

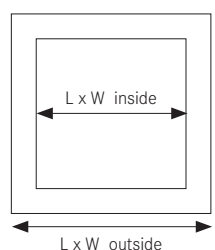

These items are subject to discount group 1.



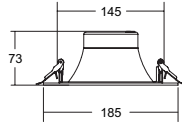

DIOS MICRO LED recessed downlight, multi-lumen, reflector matt

NEW

Lamp: LED, colour rendering: CRI > 90, glare rating: UGR < 16, power: 7.9 W, beam angle: Wide Flood (60°), material: aluminium / plastic, incl. converter for input voltage: 220 - 240 V AC, 220-240 V DC, 50 - 60 Hz, control: on/off, DALI-2 (Push Dim), reflector matt, standards/ checks: ENEC, TÜV Süd, SELV, CE, EL (IEC 61347-2-13 standard), suitable for through-wiring.

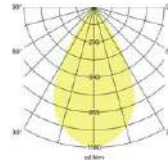

Service life:

L80/B10, 50,000 hrs. (ta: +25 °C)

| Article no. textured silver | Article no. textured white | Article no. textured black | Beam angle | Colour temp. | Luminous flux | Colour rendering | Control | System efficiency | Price in € |
|-----------------------------|----------------------------|----------------------------|------------|--------------|---------------|------------------|------------|-------------------|------------|
| 40670163 | 40670173 | 40670183 | 60° | 3,000 K | 1,000 lm | CRI>90 | switchable | 127 lm/W | 109.90 |
| 40670164 | 40670174 | 40670184 | 60° | 4,000 K | 1,130 lm | CRI>90 | switchable | 143 lm/W | 109.90 |
| 40670163DA | 40670173DA | 40670183DA | 60° | 3,000 K | 1,000 lm | CRI>90 | DALI | 127 lm/W | 164.90 |
| 40670164DA | 40670174DA | 40670184DA | 60° | 4,000 K | 1,130 lm | CRI>90 | DALI | 143 lm/W | 164.90 |

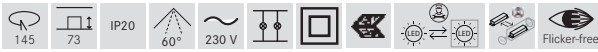

These items are subject to discount group 1.



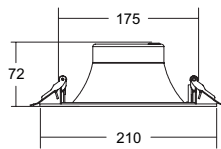

DIOS MINI LED recessed downlight, multi-lumen, reflector matt

NEW

Lamp: LED, colour rendering: CRI > 90, glare rating: UGR < 16, power: 9.7 W, beam angle: Wide Flood (58°), material: aluminium / plastic, incl. converter for input voltage: 220 - 240 V AC, 220-240 V DC, 50 - 60 Hz, control: on/off, DALI-2 (Push Dim), reflector matt, standards/ checks: ENEC, TÜV Süd, SELV, CE, EL (IEC 61347-2-13 standard), suitable for through-wiring.

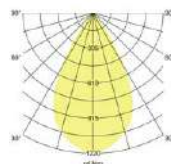

Service life:

L80/B10, 50,000 hrs. (ta: +25 °C)

| Article no. textured silver | Article no. textured white | Article no. textured black | Beam angle | Colour temp. | Luminous flux | Colour rendering | Control | System efficiency | Price in € |
|-----------------------------|----------------------------|----------------------------|------------|--------------|---------------|------------------|------------|-------------------|------------|
| 40671163 | 40671173 | 40671183 | 58° | 3,000 K | 1,250 lm | CRI>90 | switchable | 129 lm/W | 129.90 |
| 40671164 | 40671174 | 40671184 | 58° | 4,000 K | 1,365 lm | CRI>90 | switchable | 141 lm/W | 129.90 |
| 40671163DA | 40671173DA | 40671183DA | 58° | 3,000 K | 1,250 lm | CRI>90 | DALI | 129 lm/W | 184.90 |
| 40671164DA | 40671174DA | 40671184DA | 58° | 4,000 K | 1,365 lm | CRI>90 | DALI | 141 lm/W | 184.90 |



These items are subject to discount group 1.

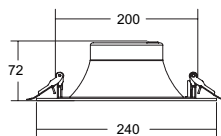

DIOS MIDI LED recessed downlight, multi-lumen, reflector matt

NEW

Lamp: LED, colour rendering: CRI > 90, glare rating: UGR < 16, power: 13.9 W, beam angle: Wide Flood (55°), material: aluminium / plastic, incl. converter for input voltage: 220 - 240 V AC, 220-240 V DC, 50 - 60 Hz, control: on/off, DALI-2 (Push Dim), reflector matt, standards/ checks: ENEC, TÜV Süd, SELV, CE, EL (IEC 61347-2-13 standard), suitable for through-wiring.

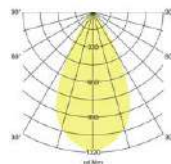

Service life:

L80/B10, 50,000 hrs. (ta: +25 °C)

| Article no. textured silver | Article no. textured white | Article no. textured black | Beam angle | Colour temp. | Luminous flux | Colour rendering | Control | System efficiency | Price in € |
|-----------------------------|----------------------------|----------------------------|------------|--------------|---------------|------------------|------------|-------------------|------------|
| 40672163 | 40672173 | 40672183 | 55° | 3,000 K | 1,725 lm | CRI>90 | switchable | 124 lm/W | 159.90 |
| 40672164 | 40672174 | 40672184 | 55° | 4,000 K | 1,840 lm | CRI>90 | switchable | 132 lm/W | 159.90 |
| 40672163DA | 40672173DA | 40672183DA | 55° | 3,000 K | 1,725 lm | CRI>90 | DALI | 124 lm/W | 214.90 |
| 40672164DA | 40672174DA | 40672184DA | 55° | 4,000 K | 1,840 lm | CRI>90 | DALI | 132 lm/W | 214.90 |



These items are subject to discount group 1.

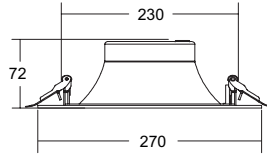

DIOS MAXI LED recessed downlight, multi-lumen, reflector matt

NEW

40614...

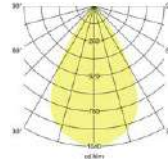

LED LIGHTING FUNDING

BEG

Lamp: LED, colour rendering: CRI > 90, glare rating: UGR < 16, power: 20.2 W, beam angle: Wide Flood (60°), material: aluminium / plastic, incl. converter for input voltage: 220 - 240 V AC, 220-240 V DC, 50 - 60 Hz, control: on/off, DALI-2 (Push Dim), reflector matt, standards/ checks: ENEC, TÜV Süd, SELV, CE, EL (IEC 61347-2-13 standard), suitable for through-wiring.

Service life:

L80/B10, 50,000 hrs. (ta: +25 °C)

| Article no. textured silver | Article no. textured white | Article no. textured black | Beam angle | Colour temp. | Luminous flux | Colour rendering | Control | System efficiency | Price in € |
|-----------------------------|----------------------------|----------------------------|------------|--------------|---------------|------------------|------------|-------------------|------------|
| 40673163 | 40673173 | 40673183 | 60° | 3,000 K | 2,400 lm | CRI>90 | switchable | 126 lm/W | 189.90 |
| 40673164 | 40673174 | 40673184 | 60° | 4,000 K | 2,680 lm | CRI>90 | switchable | 140 lm/W | 189.90 |
| 40673163DA | 40673173DA | 40673183DA | 60° | 3,000 K | 2,400 lm | CRI>90 | DALI | 126 lm/W | 249.90 |
| 40673164DA | 40673174DA | 40673184DA | 60° | 4,000 K | 2,680 lm | CRI>90 | DALI | 140 lm/W | 249.90 |



These items are subject to discount group 1.

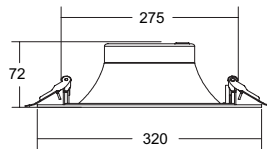

DIOS MEGA LED recessed downlight, multi-lumen, reflector matt

NEW

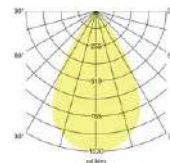

LED LIGHTING FUNDING

BEG

Lamp: LED, colour rendering: CRI > 90, glare rating: UGR < 16, power: 23.8 W, beam angle: Wide Flood (60°), material: aluminium / plastic, incl. converter for input voltage: 220 - 240 V AC, 220-240 V DC, 50 - 60 Hz, control: on/off, DALI-2 (Push Dim), reflector matt, standards/ checks: ENEC, TÜV Süd, SELV, CE, EL (IEC 61347-2-13 standard), suitable for through-wiring.

Service life:

L80/B10, 50,000 hrs. (ta: +25 °C)

| Article no. textured silver | Article no. textured white | Article no. textured black | Beam angle | Colour temp. | Luminous flux | Colour rendering | Control | System efficiency | Price in € |
|-----------------------------|----------------------------|----------------------------|------------|--------------|---------------|------------------|------------|-------------------|------------|
| 40674163 | 40674173 | 40674183 | 60° | 3,000 K | 2,862 lm | CRI>90 | switchable | 120 lm/W | 219.90 |
| 40674164 | 40674174 | 40674184 | 60° | 4,000 K | 3,180 lm | CRI>90 | switchable | 134 lm/W | 219.90 |
| 40674163DA | 40674173DA | 40674183DA | 60° | 3,000 K | 2,862 lm | CRI>90 | DALI | 120 lm/W | 279.90 |
| 40674164DA | 40674174DA | 40674184DA | 60° | 4,000 K | 3,180 lm | CRI>90 | DALI | 134 lm/W | 279.90 |



These items are subject to discount group 1.

BEG FUNDING PROGRAMME

Utilise funding opportunities.

Energy-efficient lighting for non-residential buildings.

Since 2021, the Federal Ministry for Economic Affairs and Climate Action has bundled the previous schemes for the funding of energy efficiency and renewable energies within the framework of the Climate Action Programme 2030. The BEG subsidises and supports the energy-efficient refurbishment of buildings to further reduce CO2 emissions.

Federal Funding for Efficient Buildings (BEG) covers energy-related measures for the modernisation and refurbishment of buildings. The aim of the funding is to improve the energy efficiency of residential and non-residential buildings, also with regard to the modernisation of lighting systems.



The requirements and our BEG-eligible luminaires can be found at www.brumberg.com/beg

In addition to use in non-residential buildings, these luminaires are also recommended for all other areas of application in terms of energy savings, but are not eligible for subsidies.



Secure a
15%
subsidy
now.



MUNA.

LED recessed downlight.

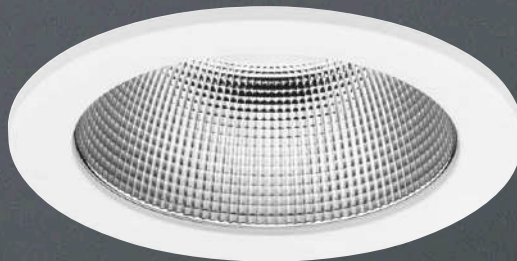
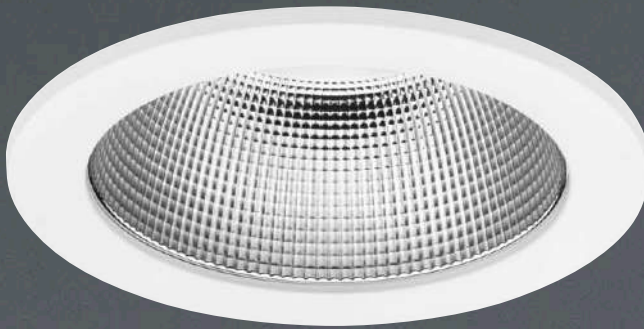
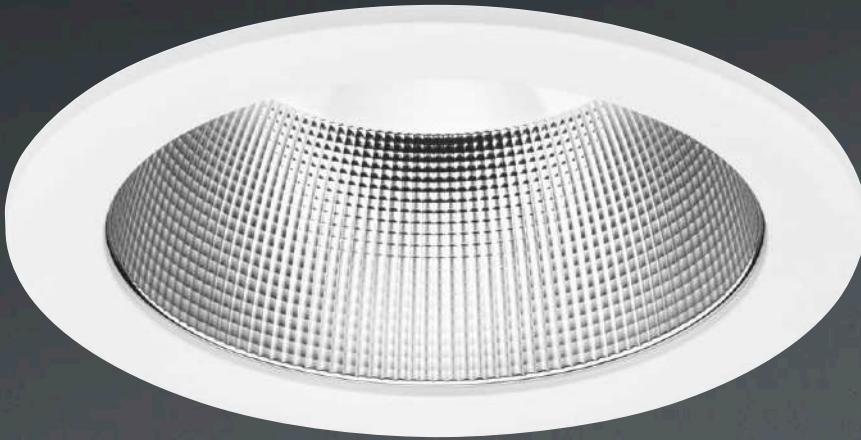

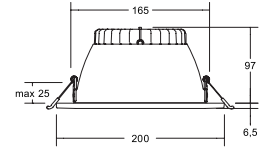
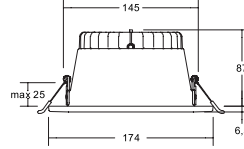
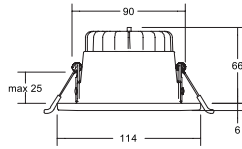
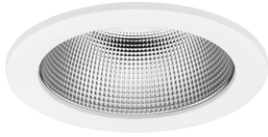

MUNA LED recessed downlight, 3CCT, UGR < 19, trailing-edge phase dimmable

NEW

Lamp: LED, colour rendering: CRI > 80, glare rating: UGR < 19, beam angle: 60°, material: aluminium / polycarbonate / steel, includes: incl. converter for connection to 230 V mains voltage, trailing-edge phase dimmable with switch for colour temperature selection. 3,000 K / 4,000 K / 5,700 K, attachment element removable (accessories see page 47)

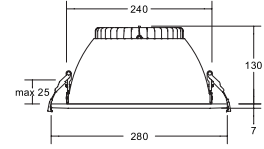
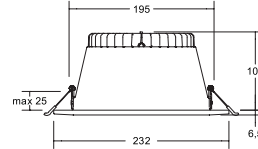

| Article no. matt white | Power | Outside diameter | Ceiling cut-out | Installation height | Colour temp. | Luminous flux | Control | System efficiency | Price in € |
|---------------------------|-------|------------------|-----------------|---------------------|-----------------------------|---------------|------------------------------|-------------------|------------|
| 12563073 | 10 W | 114 mm | 90 mm | 66 mm | 3,000 K / 4,000 K / 5,700 K | 950 lm | trailing-edge phase dimmable | 95 lm/W | 57.80 |
| 12564073 | 20 W | 174 mm | 145 mm | 87 mm | 3,000 K / 4,000 K / 5,700 K | 1,900 lm | trailing-edge phase dimmable | 95 lm/W | 83.90 |
| 12565073 | 28 W | 200 mm | 165 mm | 97 mm | 3,000 K / 4,000 K / 5,700 K | 2,660 lm | trailing-edge phase dimmable | 95 lm/W | 91.20 |
| 12567073 | 35 W | 232 mm | 195 mm | 110 mm | 3,000 K / 4,000 K / 5,700 K | 3,325 lm | trailing-edge phase dimmable | 95 lm/W | 140.40 |
| 12569073 | 50 W | 280 mm | 240 mm | 130 mm | 3,000 K / 4,000 K / 5,700 K | 4,750 lm | trailing-edge phase dimmable | 95 lm/W | 164.40 |



Luminous flux for colour temperature 4,000 K.
These items are subject to discount group 1.

MUNA.

LED recessed downlight.

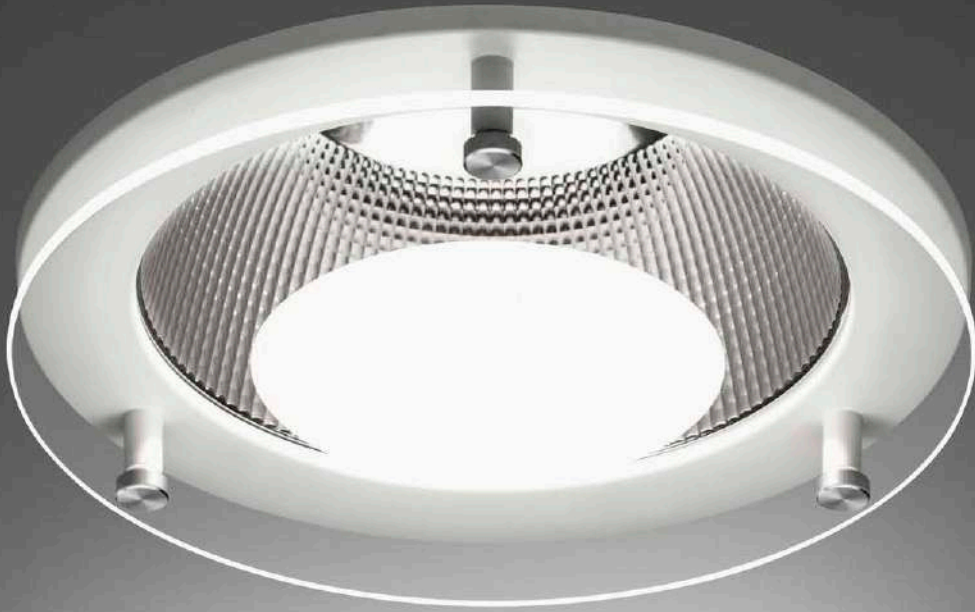

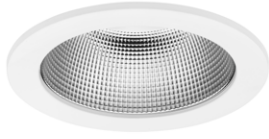

MUNA LED recessed downlight, accessories

NEW

Attachment elements and surface-mounted housing

| Article no. | Shape | Colour | Dimensions | Height | for luminaire | Price in € |
|-------------|---|------------|-----------------|---------|---------------|------------|
| 81210080 | Attachment element round | matt black | Ø 114 mm | 6 mm | 12563073 | 3.20 |
| 81215070 | Attachment element square | matt white | 114 mm x 114 mm | 6 mm | 12563073 | 3.60 |
| 81215080 | Attachment element square | matt black | 114 mm x 114 mm | 6 mm | 12563073 | 3.60 |
| 81220070 | Attachment element round, with suspended float glass partially matt | matt white | Ø 114 mm | 31 mm | 12563073 | 14.80 |
| 81220080 | Attachment element round, with suspended float glass partially matt | matt black | Ø 114 mm | 31 mm | 12563073 | 14.80 |
| 81211080 | Attachment element round | matt black | Ø 174 mm | 6.5 mm | 12564073 | 4.80 |
| 81216070 | Attachment element square | matt white | 174 mm x 174 mm | 6.5 mm | 12564073 | 6.40 |
| 81216080 | Attachment element square | matt black | 114 mm x 114 mm | 6.5 mm | 12564073 | 6.40 |
| 81221070 | Attachment element round, with suspended float glass partially matt | matt white | Ø 174 mm | 34 mm | 12564073 | 18.80 |
| 81221080 | Attachment element round, with suspended float glass partially matt | matt black | Ø 174 mm | 34 mm | 12564073 | 18.80 |
| 81230070 | Surface-mounted housing round | matt white | Ø 182 mm | 155 mm | 12564073 | 31.20 |
| 81230080 | Surface-mounted housing round | matt black | Ø 182 mm | 155 mm | 12564073 | 31.20 |
| 81212080 | Attachment element round | matt black | Ø 200 mm | 6.5 mm | 12565073 | 5.40 |
| 81217070 | Attachment element square | matt white | 200 mm x 200 mm | 6.5 mm | 12565073 | 8.00 |
| 81217080 | Attachment element square | matt black | 200 mm x 200 mm | 6.5 mm | 12565073 | 8.00 |
| 81222070 | Attachment element round, with suspended float glass partially matt | matt white | Ø 200 mm | 35 mm | 12565073 | 20.80 |
| 81222080 | Attachment element round, with suspended float glass partially matt | matt black | Ø 200 mm | 35 mm | 12565073 | 20.80 |
| 81213080 | Attachment element round | matt black | Ø 232 mm | 6.5 mm | 12567073 | 7.20 |
| 81218070 | Attachment element square | matt white | 232 mm x 232 mm | 6.5 mm | 12567073 | 9.60 |
| 81218080 | Attachment element square | matt black | 232 mm x 232 mm | 6.5 mm | 12567073 | 9.60 |
| 81223070 | Attachment element round, with suspended float glass partially matt | matt white | Ø 232 mm | 37.5 mm | 12567073 | 24.80 |
| 81223080 | Attachment element round, with suspended float glass partially matt | matt black | Ø 232 mm | 37.5 mm | 12567073 | 24.80 |
| 81231070 | Surface-mounted housing round | matt white | Ø 240 mm | 180 mm | 12567073 | 39.70 |
| 81231080 | Surface-mounted housing round | matt black | Ø 240 mm | 180 mm | 12567073 | 39.70 |
| 81214080 | Attachment element round | matt black | Ø 280 mm | 7 mm | 12569073 | 8.00 |
| 81219070 | Attachment element square | matt white | 280 mm x 280 mm | 7 mm | 12569073 | 11.20 |
| 81219080 | Attachment element square | matt black | 280 mm x 280 mm | 7 mm | 12569073 | 11.20 |
| 81224070 | Attachment element round, with suspended float glass partially matt | matt white | Ø 280 mm | 40 mm | 12569073 | 28.80 |
| 81224080 | Attachment element round, with suspended float glass partially matt | matt black | Ø 280 mm | 40 mm | 12569073 | 28.80 |

These items are subject to discount group 1.

Sizes in mm | All prices are recommended retail prices (RRP) in euros without VAT. Errors excepted. | Orders are placed in accordance with our General Terms and Conditions of Sale printed on page 486 onwards.



TRAXX spotlight system.

A light system for flexible use.

Quick configuration table:

LED track spotlight



| switchable | | | | | | | | |
|-----------------------|------------|-------|-----------------|----------------|----------------|--------------|---------|---------|
| | Beam angle | | Colour | | | Colour temp. | | |
| | | | Textured silver | Textured white | Textured black | 3,000 K | 3,500 K | 4,000 K |
| Micro 9.4 W | 30° | 88693 | 16 | 17 | 18 | 3 | 5 | 4 |
| | 40° | 88694 | 16 | 17 | 18 | 3 | 5 | 4 |
| | 60° | 88696 | 16 | 17 | 18 | 3 | 5 | 4 |
| Mini 12.5 W | 20° | 88702 | 16 | 17 | 18 | 3 | 5 | 4 |
| | 40° | 88704 | 16 | 17 | 18 | 3 | 5 | 4 |
| | 60° | 88706 | 16 | 17 | 18 | 3 | 5 | 4 |
| Midi 23 W | 25° | 88712 | 16 | 17 | 18 | 3 | 5 | 4 |
| | 30° | 88713 | 16 | 17 | 18 | 3 | 5 | 4 |
| | 50° | 88715 | 16 | 17 | 18 | 3 | 5 | 4 |
| Maxi 31 W | 20° | 88722 | 16 | 17 | 18 | 3 | 5 | 4 |
| | 30° | 88723 | 16 | 17 | 18 | 3 | 5 | 4 |
| | 40° | 88724 | 16 | 17 | 18 | 3 | 5 | 4 |

LED semi-recessed spotlights



| switchable | | | | | | | | |
|-----------------------|------------|-------|-----------------|----------------|----------------|--------------|---------|---------|
| | Beam angle | | Colour | | | Colour temp. | | |
| | | | Textured silver | Textured white | Textured black | 3,000 K | 3,500 K | 4,000 K |
| Micro 9.4 W | 30° | 88773 | 16 | 17 | 18 | 3 | 5 | 4 |
| | 40° | 88774 | 16 | 17 | 18 | 3 | 5 | 4 |
| | 60° | 88776 | 16 | 17 | 18 | 3 | 5 | 4 |
| Mini 12.5 W | 20° | 88782 | 16 | 17 | 18 | 3 | 5 | 4 |
| | 40° | 88784 | 16 | 17 | 18 | 3 | 5 | 4 |
| | 60° | 88786 | 16 | 17 | 18 | 3 | 5 | 4 |
| Midi 23 W | 25° | 88792 | 16 | 17 | 18 | 3 | 5 | 4 |
| | 30° | 88793 | 16 | 17 | 18 | 3 | 5 | 4 |
| | 50° | 88795 | 16 | 17 | 18 | 3 | 5 | 4 |
| Maxi 31 W | 20° | 88802 | 16 | 17 | 18 | 3 | 5 | 4 |
| | 30° | 88803 | 16 | 17 | 18 | 3 | 5 | 4 |
| | 40° | 88804 | 16 | 17 | 18 | 3 | 5 | 4 |

LED recessed spotlights



| switchable | | | | | | | | |
|-----------------------|------------|-------|-----------------|----------------|----------------|--------------|---------|---------|
| | Beam angle | | Colour | | | Colour temp. | | |
| | | | Textured silver | Textured white | Textured black | 3,000 K | 3,500 K | 4,000 K |
| Micro 6.8 W | 30° | 88733 | 16 | 17 | 18 | 3 | 5 | 4 |
| | 40° | 88734 | 16 | 17 | 18 | 3 | 5 | 4 |
| | 60° | 88736 | 16 | 17 | 18 | 3 | 5 | 4 |
| Mini 12.5 W | 20° | 88742 | 16 | 17 | 18 | 3 | 5 | 4 |
| | 40° | 88744 | 16 | 17 | 18 | 3 | 5 | 4 |
| | 60° | 88746 | 16 | 17 | 18 | 3 | 5 | 4 |
| Midi 19.5 W | 25° | 88752 | 16 | 17 | 18 | 3 | 5 | 4 |
| | 30° | 88753 | 16 | 17 | 18 | 3 | 5 | 4 |
| | 50° | 88755 | 16 | 17 | 18 | 3 | 5 | 4 |
| Maxi 26.4 W | 20° | 88762 | 16 | 17 | 18 | 3 | 5 | 4 |
| | 30° | 88763 | 16 | 17 | 18 | 3 | 5 | 4 |
| | 40° | 88764 | 16 | 17 | 18 | 3 | 5 | 4 |

LED surface-mounted downlights



| switchable | | | | | | | | |
|-----------------------|------------|-------|-----------------|----------------|----------------|--------------|---------|---------|
| | Beam angle | | Colour | | | Colour temp. | | |
| | | | Textured silver | Textured white | Textured black | 3,000 K | 3,500 K | 4,000 K |
| Micro 6.8 W | 30° | 88813 | 16 | 17 | 18 | 3 | 5 | 4 |
| | 40° | 88814 | 16 | 17 | 18 | 3 | 5 | 4 |
| | 60° | 88816 | 16 | 17 | 18 | 3 | 5 | 4 |
| Mini 12.5 W | 20° | 88822 | 16 | 17 | 18 | 3 | 5 | 4 |
| | 40° | 88824 | 16 | 17 | 18 | 3 | 5 | 4 |
| | 60° | 88826 | 16 | 17 | 18 | 3 | 5 | 4 |
| Midi 19.5 W | 25° | 88832 | 16 | 17 | 18 | 3 | 5 | 4 |
| | 30° | 88833 | 16 | 17 | 18 | 3 | 5 | 4 |
| | 50° | 88835 | 16 | 17 | 18 | 3 | 5 | 4 |
| Maxi 26.4 W | 20° | 88842 | 16 | 17 | 18 | 3 | 5 | 4 |
| | 30° | 88843 | 16 | 17 | 18 | 3 | 5 | 4 |
| | 40° | 88844 | 16 | 17 | 18 | 3 | 5 | 4 |

LED pendant luminaires



| switchable | | | | | | | | |
|-----------------------|------------|-------|-----------------|----------------|----------------|--------------|---------|---------|
| | Beam angle | | Colour | | | Colour temp. | | |
| | | | Textured silver | Textured white | Textured black | 3,000 K | 3,500 K | 4,000 K |
| Micro 6.8 W | 30° | 88853 | 16 | 17 | 18 | 3 | 5 | 4 |
| | 40° | 88854 | 16 | 17 | 18 | 3 | 5 | 4 |
| | 60° | 88856 | 16 | 17 | 18 | 3 | 5 | 4 |
| Mini 12.5 W | 20° | 88862 | 16 | 17 | 18 | 3 | 5 | 4 |
| | 40° | 88864 | 16 | 17 | 18 | 3 | 5 | 4 |
| | 60° | 88866 | 16 | 17 | 18 | 3 | 5 | 4 |
| Midi 19.5 W | 25° | 88872 | 16 | 17 | 18 | 3 | 5 | 4 |
| | 30° | 88873 | 16 | 17 | 18 | 3 | 5 | 4 |
| | 50° | 88875 | 16 | 17 | 18 | 3 | 5 | 4 |
| Maxi 26.4 W | 20° | 88882 | 16 | 17 | 18 | 3 | 5 | 4 |
| | 30° | 88883 | 16 | 17 | 18 | 3 | 5 | 4 |
| | 40° | 88884 | 16 | 17 | 18 | 3 | 5 | 4 |

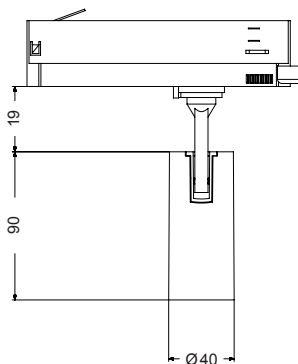

TRAXX MICRO LED track spotlights

Luminaire incl. Euro adapter for standard 3-phase tracks, lamp: LED, incl. converter for 230 V mains voltage, power: 11 W, control: switchable, material: aluminium / glass / plastic, includes: operating unit, switchable

Service life:

L80/B50, 50,000 hrs. (ta: +25 °C)

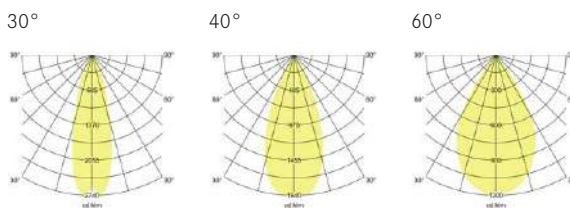

| Article no. textured silver | Article no. textured white | Article no. textured black | Beam angle | Colour temp. | Luminous flux | Colour rendering | System efficiency | Price in € |
|-----------------------------|----------------------------|----------------------------|------------|--------------|---------------|------------------|-------------------|------------|
| 88693163 | 88693173 | 88693183 | 30° | 3,000 K | 1,385 lm | CRI>90 | 126 lm/W | 119.90 |
| 88693165 | 88693175 | 88693185 | 30° | 3,500 K | 1,365 lm | CRI>90 | 124 lm/W | 119.90 |
| 88693164 | 88693174 | 88693184 | 30° | 4,000 K | 1,365 lm | CRI>90 | 124 lm/W | 119.90 |
| 88694163 | 88694173 | 88694183 | 40° | 3,000 K | 1,391 lm | CRI>90 | 126 lm/W | 119.90 |
| 88694165 | 88694175 | 88694185 | 40° | 3,500 K | 1,331 lm | CRI>90 | 121 lm/W | 119.90 |
| 88694164 | 88694174 | 88694184 | 40° | 4,000 K | 1,340 lm | CRI>90 | 121 lm/W | 119.90 |
| 88696163 | 88696173 | 88696183 | 60° | 3,000 K | 1,340 lm | CRI>90 | 121 lm/W | 119.90 |
| 88696165 | 88696175 | 88696185 | 60° | 3,500 K | 1,331 lm | CRI>90 | 121 lm/W | 119.90 |
| 88696164 | 88696174 | 88696184 | 60° | 4,000 K | 1,340 lm | CRI>90 | 121 lm/W | 119.90 |

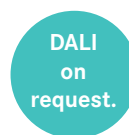

These items are subject to discount group 1.

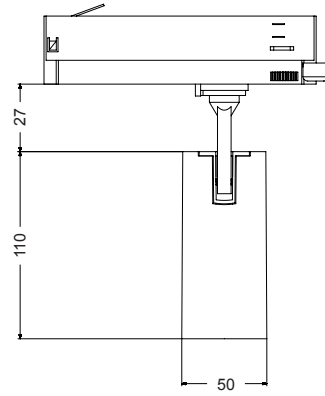

TRAXX MINI LED track spotlights

Luminaire incl. Euro adapter for standard 3-phase tracks, lamp: LED, incl. converter for 230 V mains voltage, power: 14.5 W, control: switchable, material: aluminium / glass / plastic, includes: operating unit, switchable

Service life:

L80/B50, 50,000 hrs. (ta: +25 °C)

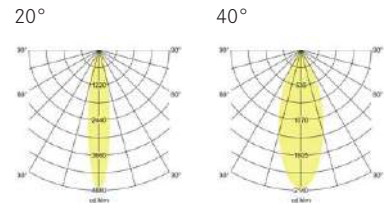

| Article no. textured silver | Article no. textured white | Article no. textured black | Beam angle | Colour temp. | Luminous flux | Colour rendering | System efficiency | Price in € |
|-----------------------------|----------------------------|----------------------------|------------|--------------|---------------|------------------|-------------------|------------|
| 88702163 | 88702173 | 88702183 | 20° | 3,000 K | 1,745 lm | CRI > 90 | 120 lm/W | 142.90 |
| 88702165 | 88702175 | 88702185 | 20° | 3,500 K | 1,757 lm | CRI > 90 | 121 lm/W | 142.90 |
| 88702164 | 88702174 | 88702184 | 20° | 4,000 K | 1,766 lm | CRI > 90 | 131 lm/W | 142.90 |
| 88704163 | 88704173 | 88704183 | 40° | 3,000 K | 1,733 lm | CRI > 90 | 120 lm/W | 142.90 |
| 88704165 | 88704175 | 88704185 | 40° | 3,500 K | 1,740 lm | CRI > 90 | 120 lm/W | 142.90 |
| 88704164 | 88704174 | 88704184 | 40° | 4,000 K | 1,745 lm | CRI > 90 | 120 lm/W | 142.90 |
| 88706163 | 88706173 | 88706183 | 60° | 3,000 K | 1,755 lm | CRI > 90 | 121 lm/W | 142.90 |
| 88706165 | 88706175 | 88706185 | 60° | 3,500 K | 1,773 lm | CRI > 90 | 122 lm/W | 142.90 |
| 88706164 | 88706174 | 88706184 | 60° | 4,000 K | 1,782 lm | CRI > 90 | 122 lm/W | 142.90 |



These items are subject to discount group 1.

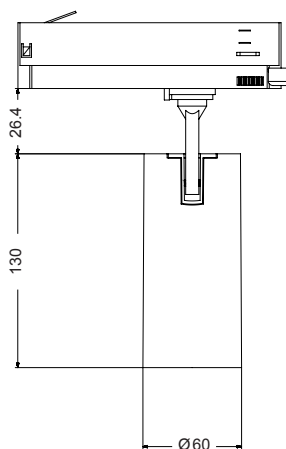

TRAXX MIDI LED track spotlights

Luminaire incl. Euro adapter for standard 3-phase tracks, lamp: LED, incl. converter for 230 V mains voltage, power: 21 W, control: switchable, material: aluminium / glass / plastic, includes: operating unit, switchable

Service life:

L80/B50, 50,000 hrs. (ta: +25 °C)

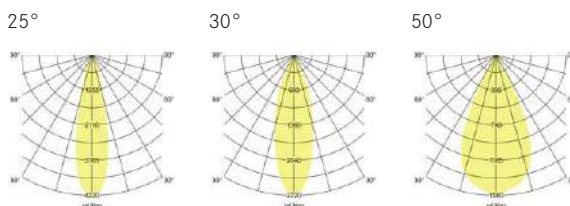

| Article no. textured silver | Article no. textured white | Article no. textured black | Beam angle | Colour temp. | Luminous flux | Colour rendering | System efficiency | Price in € |
|-----------------------------|----------------------------|----------------------------|------------|--------------|---------------|------------------|-------------------|------------|
| 88712163 | 88712173 | 88712183 | 25° | 3,000 K | 2,700 lm | CRI>90 | 129 lm/W | 182.90 |
| 88712165 | 88712175 | 88712185 | 25° | 3,500 K | 2,633 lm | CRI>90 | 125 lm/W | 182.90 |
| 88712164 | 88712174 | 88712184 | 25° | 4,000 K | 2,554 lm | CRI>90 | 122 lm/W | 182.90 |
| 88713163 | 88713173 | 88713183 | 30° | 3,000 K | 2,672 lm | CRI>90 | 127 lm/W | 182.90 |
| 88713165 | 88713175 | 88713185 | 30° | 3,500 K | 2,565 lm | CRI>90 | 122 lm/W | 182.90 |
| 88713164 | 88713174 | 88713184 | 30° | 4,000 K | 2,537 lm | CRI>90 | 121 lm/W | 182.90 |
| 88715163 | 88715173 | 88715183 | 50° | 3,000 K | 2,605 lm | CRI>90 | 124 lm/W | 182.90 |
| 88715165 | 88715175 | 88715185 | 50° | 3,500 K | 2,554 lm | CRI>90 | 122 lm/W | 182.90 |
| 88715164 | 88715174 | 88715184 | 50° | 4,000 K | 2,570 lm | CRI>90 | 122 lm/W | 182.90 |

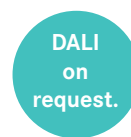

These items are subject to discount group 1.

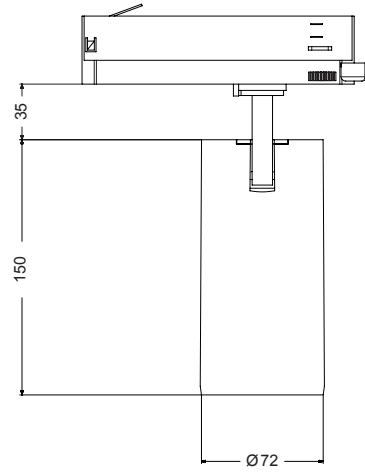

TRAXX MAXI LED track spotlights

Luminaire incl. Euro adapter for standard 3-phase tracks, lamp: LED, incl. converter for 230 V mains voltage, power: 24 W, control: switchable, material: aluminium / glass / plastic, includes: operating unit, switchable

Service life:

L80/B50, 50,000 hrs. (ta: +25 °C)

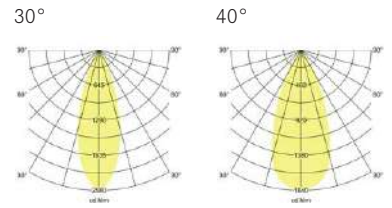

| Article no. textured silver | Article no. textured white | Article no. textured black | Beam angle | Colour temp. | Luminous flux | Colour rendering | System efficiency | Price in € |
|-----------------------------|----------------------------|----------------------------|------------|--------------|---------------|------------------|-------------------|------------|
| 88722163 | 88722173 | 88722183 | 20° | 3,000 K | 2,926 lm | CRI > 90 | 122 lm/W | 205.90 |
| 88722165 | 88722175 | 88722185 | 20° | 3,500 K | 2,943 lm | CRI > 90 | 123 lm/W | 205.90 |
| 88722164 | 88722174 | 88722184 | 20° | 4,000 K | 2,942 lm | CRI > 90 | 117 lm/W | 205.90 |
| 88723163 | 88723173 | 88723183 | 30° | 3,000 K | 2,880 lm | CRI > 90 | 120 lm/W | 205.90 |
| 88723165 | 88723175 | 88723185 | 30° | 3,500 K | 2,880 lm | CRI > 90 | 120 lm/W | 205.90 |
| 88723164 | 88723174 | 88723184 | 30° | 4,000 K | 2,888 lm | CRI > 90 | 120 lm/W | 205.90 |
| 88724163 | 88724173 | 88724183 | 40° | 3,000 K | 3,095 lm | CRI > 90 | 129 lm/W | 205.90 |
| 88724165 | 88724175 | 88724185 | 40° | 3,500 K | 3,044 lm | CRI > 90 | 127 lm/W | 205.90 |
| 88724164 | 88724174 | 88724184 | 40° | 4,000 K | 3,056 lm | CRI > 90 | 127 lm/W | 205.90 |



These items are subject to discount group 1.



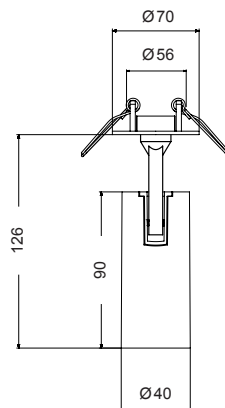

TRAXX MICRO LED semi-recessed spotlights

Lamp: LED, incl. converter for 230 V mains voltage, power: 11 W, control: switchable, material: aluminium / glass / plastic, includes: operating unit, switchable

Service life:

L80/B50, 50,000 hrs. (ta: +25 °C)

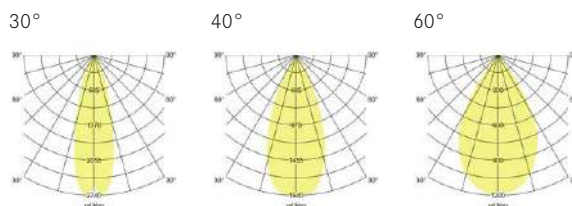

| Article no. textured silver | Article no. textured white | Article no. textured black | Beam angle | Colour temp. | Luminous flux | Colour rendering | System efficiency | Price in € |
|-----------------------------|----------------------------|----------------------------|------------|--------------|---------------|------------------|-------------------|------------|
| 88773163 | 88773173 | 88773183 | 30° | 3,000 K | 1,385 lm | CRI>90 | 126 lm/W | 99.90 |
| 88773165 | 88773175 | 88773185 | 30° | 3,500 K | 1,365 lm | CRI>90 | 124 lm/W | 99.90 |
| 88773164 | 88773174 | 88773184 | 30° | 4,000 K | 1.2365 lm | CRI>90 | 124 lm/W | 99.90 |
| 88774163 | 88774173 | 88774183 | 40° | 3,000 K | 1,391 lm | CRI>90 | 126 lm/W | 99.90 |
| 88774165 | 88774175 | 88774185 | 40° | 3,500 K | 1,320 lm | CRI>90 | 120 lm/W | 99.90 |
| 88774164 | 88774174 | 88774184 | 40° | 4,000 K | 1,320 lm | CRI>90 | 120 lm/W | 99.90 |
| 88776163 | 88776173 | 88776183 | 60° | 3,000 K | 1,340 lm | CRI>90 | 122 lm/W | 99.90 |
| 88776165 | 88776175 | 88776185 | 60° | 3,500 K | 1,320 lm | CRI>90 | 120 lm/W | 99.90 |
| 88776164 | 88776174 | 88776184 | 60° | 4,000 K | 1,320 lm | CRI>90 | 120 lm/W | 99.90 |

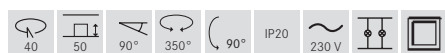
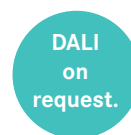

These items are subject to discount group 1.

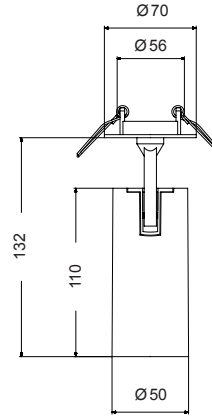

TRAXX MINI LED semi-recessed spotlights

Lamp: LED, incl. converter for 230 V mains voltage, power: 14.5 W, control: switchable, material: aluminium / glass / plastic, includes: operating unit, switchable

Service life:

L80/B50, 50,000 hrs. (ta: +25 °C)

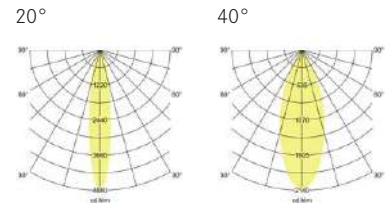

| Article no. textured silver | Article no. textured white | Article no. textured black | Beam angle | Colour temp. | Luminous flux | Colour rendering | System efficiency | Price in € |
|-----------------------------|----------------------------|----------------------------|------------|--------------|---------------|------------------|-------------------|------------|
| 88782163 | 88782173 | 88782183 | 20° | 3,000 K | 1,745 lm | CRI > 90 | 120 lm/W | 122.90 |
| 88782165 | 88782175 | 88782185 | 20° | 3,500 K | 1,757 lm | CRI > 90 | 121 lm/W | 122.90 |
| 88782164 | 88782174 | 88782184 | 20° | 4,000 K | 1,766 lm | CRI > 90 | 122 lm/W | 122.90 |
| 88784163 | 88784173 | 88784183 | 40° | 3,000 K | 1,740 lm | CRI > 90 | 120 lm/W | 122.90 |
| 88784165 | 88784175 | 88784185 | 40° | 3,500 K | 1,740 lm | CRI > 90 | 120 lm/W | 122.90 |
| 88784164 | 88784174 | 88784184 | 40° | 4,000 K | 1,745 lm | CRI > 90 | 120 lm/W | 122.90 |
| 88786163 | 88786173 | 88786183 | 60° | 3,000 K | 1,756 lm | CRI > 90 | 121 lm/W | 122.90 |
| 88786165 | 88786175 | 88786185 | 60° | 3,500 K | 1,773 lm | CRI > 90 | 122 lm/W | 122.90 |
| 88786164 | 88786174 | 88786184 | 60° | 4,000 K | 1,782 lm | CRI > 90 | 123 lm/W | 122.90 |



These items are subject to discount group 1.

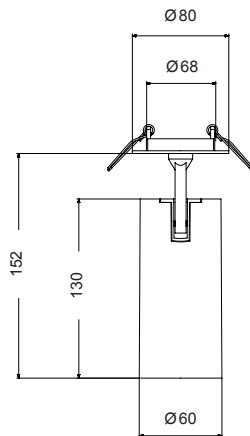

TRAXX MIDI LED semi-recessed spotlights

Lamp: LED, incl. converter for 230 V mains voltage, power: 21 W, control: switchable, material: aluminium / glass / plastic, includes: operating unit, switchable

Service life:

L80/B50, 50,000 hrs. (ta: +25 °C)

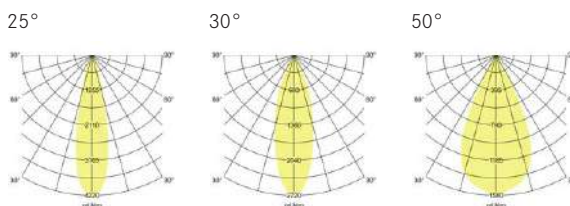

| Article no. textured silver | Article no. textured white | Article no. textured black | Beam angle | Colour temp. | Luminous flux | Colour rendering | System efficiency | Price in € |
|-----------------------------|----------------------------|----------------------------|------------|--------------|---------------|------------------|-------------------|------------|
| 88792163 | 88792173 | 88792183 | 25° | 3,000 K | 2,702 lm | CRI>90 | 129 lm/W | 168.90 |
| 88792165 | 88792175 | 88792185 | 25° | 3,500 K | 2,520 lm | CRI>90 | 120 lm/W | 168.90 |
| 88792164 | 88792174 | 88792184 | 25° | 4,000 K | 2,617 lm | CRI>90 | 125 lm/W | 168.90 |
| 88793163 | 88793173 | 88793183 | 30° | 3,000 K | 2,620 lm | CRI>90 | 125 lm/W | 168.90 |
| 88793165 | 88793175 | 88793185 | 30° | 3,500 K | 2,520 lm | CRI>90 | 120 lm/W | 168.90 |
| 88793164 | 88793174 | 88793184 | 30° | 4,000 K | 2,520 lm | CRI>90 | 120 lm/W | 168.90 |
| 88795163 | 88795173 | 88795183 | 50° | 3,000 K | 2,612 lm | CRI>90 | 124 lm/W | 168.90 |
| 88795165 | 88795175 | 88795185 | 50° | 3,500 K | 2,586 lm | CRI>90 | 123 lm/W | 168.90 |
| 88795164 | 88795174 | 88795184 | 50° | 4,000 K | 2,555 lm | CRI>90 | 122 lm/W | 168.90 |

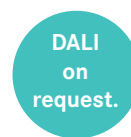

These items are subject to discount group 1.

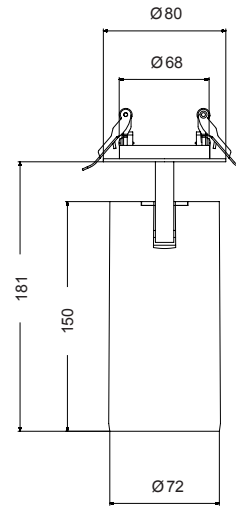

TRAXX MAXI LED semi-recessed spotlights

Lamp: LED, incl. converter for 230 V mains voltage, power: 24 W, control: switchable, material: aluminium / glass / plastic, includes: operating unit, switchable

Service life:

L80/B50, 50,000 hrs. (ta: +25 °C)

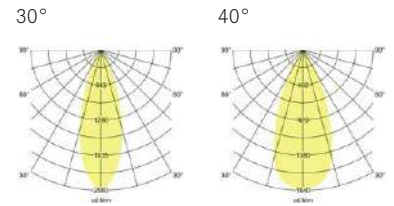

| Article no. textured silver | Article no. textured white | Article no. textured black | Beam angle | Colour temp. | Luminous flux | Colour rendering | System efficiency | Price in € |
|-----------------------------|----------------------------|----------------------------|------------|--------------|---------------|------------------|-------------------|------------|
| 88802163 | 88802173 | 88802183 | 20° | 3,000 K | 2,943 lm | CRI > 90 | 114 lm/W | 191.90 |
| 88802165 | 88802175 | 88802185 | 20° | 3,500 K | 2,935 lm | CRI > 90 | 115 lm/W | 191.90 |
| 88802164 | 88802174 | 88802184 | 20° | 4,000 K | 2,947 lm | CRI > 90 | 117 lm/W | 191.90 |
| 88803163 | 88803173 | 88803183 | 30° | 3,000 K | 2,842 lm | CRI > 90 | 123 lm/W | 191.90 |
| 88803165 | 88803175 | 88803185 | 30° | 3,500 K | 2,840 lm | CRI > 90 | 124 lm/W | 191.90 |
| 88803164 | 88803174 | 88803184 | 30° | 4,000 K | 2,857 lm | CRI > 90 | 126 lm/W | 191.90 |
| 88804163 | 88804173 | 88804183 | 40° | 3,000 K | 3,072 lm | CRI > 90 | 128 lm/W | 191.90 |
| 88804165 | 88804175 | 88804185 | 40° | 3,500 K | 3,085 lm | CRI > 90 | 130 lm/W | 191.90 |
| 88804164 | 88804174 | 88804184 | 40° | 4,000 K | 3,098 lm | CRI > 90 | 131 lm/W | 191.90 |



These items are subject to discount group 1.

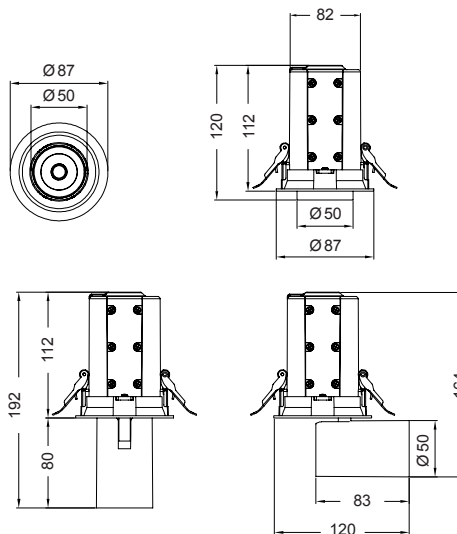

TRAXX MICRO LED recessed spotlight

Lamp: LED, incl. converter for 230 V mains voltage, power: 9 W, control: switchable, material: aluminium / glass / plastic, includes: operating unit, switchable

Service life:

L80/B50, 50,000 hrs. (ta: +25 °C)

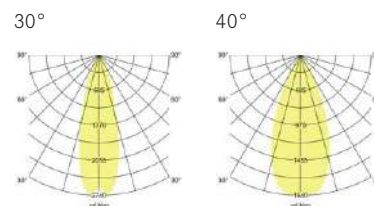

| Article no. textured silver | Article no. textured white | Article no. textured black | Beam angle | Colour temp. | Luminous flux | Colour rendering | System efficiency | Price in € |
|-----------------------------|----------------------------|----------------------------|------------|--------------|---------------|------------------|-------------------|------------|
| 88733163 | 88733173 | 88733183 | 30° | 3,000 K | 1,081 lm | CRI>90 | 120 lm/W | 99.90 |
| 88733165 | 88733175 | 88733185 | 30° | 3,500 K | 1,093 lm | CRI>90 | 121 lm/W | 99.90 |
| 88733164 | 88733174 | 88733184 | 30° | 4,000 K | 1,101 lm | CRI>90 | 122 lm/W | 99.90 |
| 88734163 | 88734173 | 88734183 | 40° | 3,000 K | 1,084 lm | CRI>90 | 120 lm/W | 99.90 |
| 88734165 | 88734175 | 88734185 | 40° | 3,500 K | 1,085 lm | CRI>90 | 121 lm/W | 99.90 |
| 88734164 | 88734174 | 88734184 | 40° | 4,000 K | 1,093 lm | CRI>90 | 121 lm/W | 99.90 |
| 88736163 | 88736173 | 88736183 | 60° | 3,000 K | 1,092 lm | CRI>90 | 121 lm/W | 99.90 |
| 88736165 | 88736175 | 88736185 | 60° | 3,500 K | 1,099 lm | CRI>90 | 122 lm/W | 99.90 |
| 88736164 | 88736174 | 88736184 | 60° | 4,000 K | 1,107 lm | CRI>90 | 123 lm/W | 99.90 |

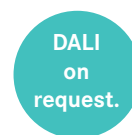

These items are subject to discount group 1.

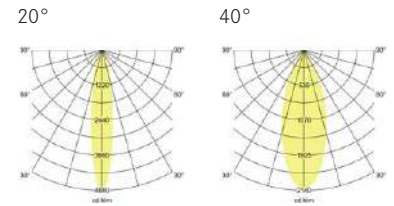
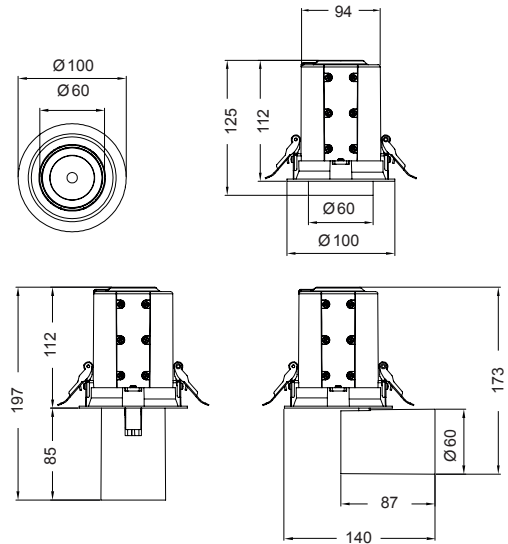

TRAXX MINI LED recessed spotlight

Lamp: LED, incl. converter for 230 V mains voltage, power: 15 W, control: switchable, material: aluminium / glass / plastic, includes: operating unit, switchable

Service life:

L80/B50, 50,000 hrs. (ta: +25 °C)

| Article no. textured silver | Article no. textured white | Article no. textured black | Beam angle | Colour temp. | Luminous flux | Colour rendering | System efficiency | Price in € |
|-----------------------------|----------------------------|----------------------------|------------|--------------|---------------|------------------|-------------------|------------|
| 88742163 | 88742173 | 88742183 | 20° | 3,000 K | 1,817 lm | CRI > 90 | 121 lm/W | 139.90 |
| 88742165 | 88742175 | 88742185 | 20° | 3,500 K | 1,800 lm | CRI > 90 | 120 lm/W | 139.90 |
| 88742164 | 88742174 | 88742184 | 20° | 4,000 K | 1,800 lm | CRI > 90 | 120 lm/W | 139.90 |
| 88744163 | 88744173 | 88744183 | 40° | 3,000 K | 1,859 lm | CRI > 90 | 124 lm/W | 139.90 |
| 88744165 | 88744175 | 88744185 | 40° | 3,500 K | 1,827 lm | CRI > 90 | 122 lm/W | 139.90 |
| 88744164 | 88744174 | 88744184 | 40° | 4,000 K | 1,819 lm | CRI > 90 | 122 lm/W | 139.90 |
| 88746163 | 88746173 | 88746183 | 60° | 3,000 K | 1,874 lm | CRI > 90 | 125 lm/W | 139.90 |
| 88746165 | 88746175 | 88746185 | 60° | 3,500 K | 1,800 lm | CRI > 90 | 120 lm/W | 139.90 |
| 88746164 | 88746174 | 88746184 | 60° | 4,000 K | 1,813 lm | CRI > 90 | 121 lm/W | 139.90 |



These items are subject to discount group 1.

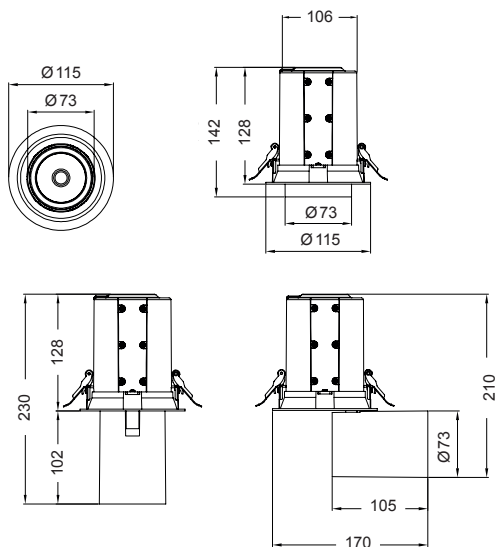

TRAXX MIDI LED recessed spotlight

Lamp: LED, incl. converter for 230 V mains voltage, power: 20 W, control: switchable, material: aluminium / glass / plastic, includes: operating unit, switchable

Service life:

L80/B50, 50,000 hrs. (ta: +25 °C)

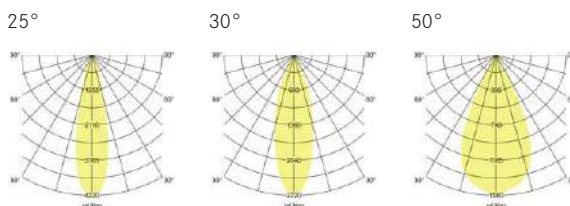

| Article no. textured silver | Article no. textured white | Article no. textured black | Beam angle | Colour temp. | Luminous flux | Colour rendering | System efficiency | Price in € |
|-----------------------------|----------------------------|----------------------------|------------|--------------|---------------|------------------|-------------------|------------|
| 88752163 | 88752173 | 88752183 | 25° | 3,000 K | 2,404 lm | CRI>90 | 120 lm/W | 179.90 |
| 88752165 | 88752175 | 88752185 | 25° | 3,500 K | 2,692 lm | CRI>90 | 135 lm/W | 179.90 |
| 88752164 | 88752174 | 88752184 | 25° | 4,000 K | 2,681 lm | CRI>90 | 134 lm/W | 179.90 |
| 88753163 | 88753173 | 88753183 | 30° | 3,000 K | 2,513 lm | CRI>90 | 126 lm/W | 179.90 |
| 88753165 | 88753175 | 88753185 | 30° | 3,500 K | 2,553 lm | CRI>90 | 128 lm/W | 179.90 |
| 88753164 | 88753174 | 88753184 | 30° | 4,000 K | 2,553 lm | CRI>90 | 128 lm/W | 179.90 |
| 88755163 | 88755173 | 88755183 | 50° | 3,000 K | 2,714 lm | CRI>90 | 136 lm/W | 179.90 |
| 88755165 | 88755175 | 88755185 | 50° | 3,500 K | 2,724 lm | CRI>90 | 136 lm/W | 179.90 |
| 88755164 | 88755174 | 88755184 | 50° | 4,000 K | 2,708 lm | CRI>90 | 135 lm/W | 179.90 |

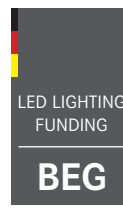

These items are subject to discount group 1.

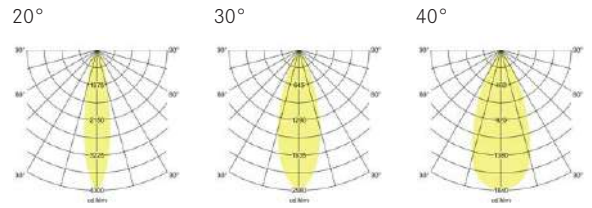
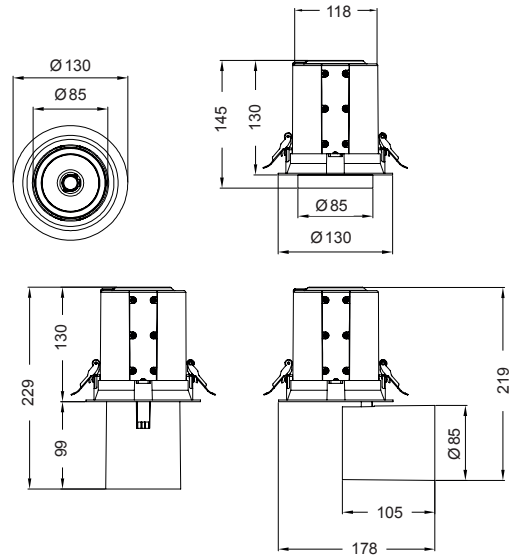

TRAXX MAXI LED recessed spotlight

Lamp: LED, incl. converter for 230 V mains voltage, power: 27 W, control: switchable, material: aluminium / glass / plastic, includes: operating unit, switchable

Service life:

L80/B50, 50,000 hrs. (ta: +25 °C)

| Article no. textured silver | Article no. textured white | Article no. textured black | Beam angle | Colour temp. | Luminous flux | Colour rendering | System efficiency | Price in € |
|-----------------------------|----------------------------|----------------------------|------------|--------------|---------------|------------------|-------------------|------------|
| 88762163 | 88762173 | 88762183 | 20° | 3,000 K | 3,555 lm | CRI >90 | 132 lm/W | 199.90 |
| 88762165 | 88762175 | 88762185 | 20° | 3,500 K | 3,529 lm | CRI >90 | 131 lm/W | 199.90 |
| 88762164 | 88762174 | 88762184 | 20° | 4,000 K | 3,555 lm | CRI >90 | 132 lm/W | 199.90 |
| 88763163 | 88763173 | 88763183 | 30° | 3,000 K | 3,546 lm | CRI >90 | 131 lm/W | 199.90 |
| 88763165 | 88763175 | 88763185 | 30° | 3,500 K | 3,550 lm | CRI >90 | 131 lm/W | 199.90 |
| 88763164 | 88763174 | 88763184 | 30° | 4,000 K | 3,567 lm | CRI >90 | 132 lm/W | 199.90 |
| 88764163 | 88764173 | 88764183 | 40° | 3,000 K | 3,709 lm | CRI >90 | 137 lm/W | 199.90 |
| 88764165 | 88764175 | 88764185 | 40° | 3,500 K | 3,693 lm | CRI >90 | 137 lm/W | 199.90 |
| 88764164 | 88764174 | 88764184 | 40° | 4,000 K | 3,748 lm | CRI >90 | 139 lm/W | 199.90 |



These items are subject to discount group 1.

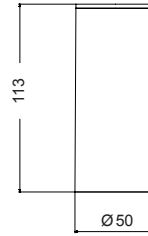

TRAXX MICRO LED surface-mounted downlight

Lamp: LED, incl. converter for 230 V mains voltage, power: 9 W, control: switchable, material: aluminium, includes: operating unit, switchable

Service life:

L80/B50, 50,000 hrs. (ta: +25 °C)

30°

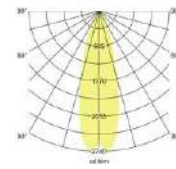

40°

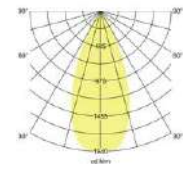

| Article no. textured silver | Article no. textured white | Article no. textured black | Beam angle | Colour temp. | Luminous flux | Colour rendering | System efficiency | Price in € |
|-----------------------------|----------------------------|----------------------------|------------|--------------|---------------|------------------|-------------------|------------|
| 88813163 | 88813173 | 88813183 | 30° | 3,000 K | 1,081 lm | CRI>90 | 120 lm/W | 94.90 |
| 88813165 | 88813175 | 88813185 | 30° | 3,500 K | 1,093 lm | CRI>90 | 121 lm/W | 94.90 |
| 88813164 | 88813174 | 88813184 | 30° | 4,000 K | 1,100 lm | CRI>90 | 122 lm/W | 94.90 |
| 88814163 | 88814173 | 88814183 | 40° | 3,000 K | 1,080 lm | CRI>90 | 120 lm/W | 94.90 |
| 88814165 | 88814175 | 88814185 | 40° | 3,500 K | 1,085 lm | CRI>90 | 120 lm/W | 94.90 |
| 88814164 | 88814174 | 88814184 | 40° | 4,000 K | 1,093 lm | CRI>90 | 121 lm/W | 94.90 |
| 88816163 | 88816173 | 88816183 | 60° | 3,000 K | 1,092 lm | CRI>90 | 121 lm/W | 94.90 |
| 88816165 | 88816175 | 88816185 | 60° | 3,500 K | 1,099 lm | CRI>90 | 122 lm/W | 94.90 |
| 88816164 | 88816174 | 88816184 | 60° | 4,000 K | 1,107 lm | CRI>90 | 123 lm/W | 94.90 |

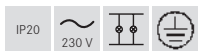

These items are subject to discount group 1.

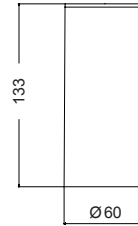

TRAXX MINI LED surface-mounted downlight

Lamp: LED, incl. converter for 230 V mains voltage, power: 14.5 W, control: switchable, material: aluminium, includes: operating unit, switchable

Service life:

L80/B50, 50,000 hrs. (ta: +25 °C)

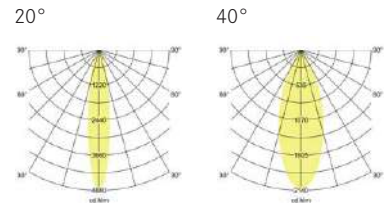

| Article no. textured silver | Article no. textured white | Article no. textured black | Beam angle | Colour temp. | Luminous flux | Colour rendering | System efficiency | Price in € |
|-----------------------------|----------------------------|----------------------------|------------|--------------|---------------|------------------|-------------------|------------|
| 88822163 | 88822173 | 88822183 | 20° | 3,000 K | 1,791 lm | CRI > 90 | 124 lm/W | 114.90 |
| 88822165 | 88822175 | 88822185 | 20° | 3,500 K | 1,785 lm | CRI > 90 | 123 lm/W | 114.90 |
| 88822164 | 88822174 | 88822184 | 20° | 4,000 K | 1,770 lm | CRI > 90 | 122 lm/W | 114.90 |
| 88824163 | 88824173 | 88824183 | 40° | 3,000 K | 1,846 lm | CRI > 90 | 127 lm/W | 114.90 |
| 88824165 | 88824175 | 88824185 | 40° | 3,500 K | 1,811 lm | CRI > 90 | 125 lm/W | 114.90 |
| 88824164 | 88824174 | 88824184 | 40° | 4,000 K | 1,822 lm | CRI > 90 | 126 lm/W | 114.90 |
| 88826163 | 88826173 | 88826183 | 60° | 3,000 K | 1,858 lm | CRI > 90 | 128 lm/W | 114.90 |
| 88826165 | 88826175 | 88826185 | 60° | 3,500 K | 1,833 lm | CRI > 90 | 126 lm/W | 114.90 |
| 88826164 | 88826174 | 88826184 | 60° | 4,000 K | 1,854 lm | CRI > 90 | 128 lm/W | 114.90 |



These items are subject to discount group 1.

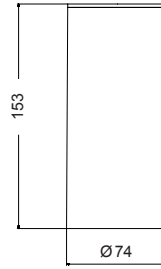

TRAXX MIDI LED surface-mounted downlight

Lamp: LED, incl. converter for 230 V mains voltage, power: 20 W, control: switchable, material: aluminium, includes: operating unit, switchable

Service life:

L80/B50, 50,000 hrs. (ta: +25 °C)

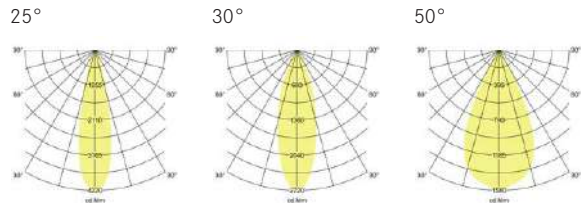

| Article no. textured silver | Article no. textured white | Article no. textured black | Beam angle | Colour temp. | Luminous flux | Colour rendering | System efficiency | Price in € |
|-----------------------------|----------------------------|----------------------------|------------|--------------|---------------|------------------|-------------------|------------|
| 88832163 | 88832173 | 88832183 | 25° | 3,000 K | 2,595 lm | CRI>90 | 130 lm/W | 155.90 |
| 88832165 | 88832175 | 88832185 | 25° | 3,500 K | 2,558 lm | CRI>90 | 128 lm/W | 155.90 |
| 88832164 | 88832174 | 88832184 | 25° | 4,000 K | 2,614 lm | CRI>90 | 131 lm/W | 155.90 |
| 88833163 | 88833173 | 88833183 | 30° | 3,000 K | 2,408 lm | CRI>90 | 120 lm/W | 155.90 |
| 88833165 | 88833175 | 88833185 | 30° | 3,500 K | 2,400 lm | CRI>90 | 120 lm/W | 155.90 |
| 88833164 | 88833174 | 88833184 | 30° | 4,000 K | 2,430 lm | CRI>90 | 122 lm/W | 155.90 |
| 88835163 | 88835173 | 88835183 | 50° | 3,000 K | 2,550 lm | CRI>90 | 128 lm/W | 155.90 |
| 88835165 | 88835175 | 88835185 | 50° | 3,500 K | 2,565 lm | CRI>90 | 128 lm/W | 155.90 |
| 88835164 | 88835174 | 88835184 | 50° | 4,000 K | 2,664 lm | CRI>90 | 133 lm/W | 155.90 |

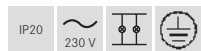

These items are subject to discount group 1.

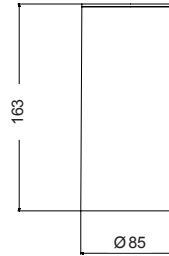

TRAXX MAXI LED surface-mounted downlight

Lamp: LED, incl. converter for 230 V mains voltage, power: 28 W, control: switchable, material: aluminium, includes: operating unit, switchable

Service life:

L80/B50, 50,000 hrs. (ta: +25 °C)

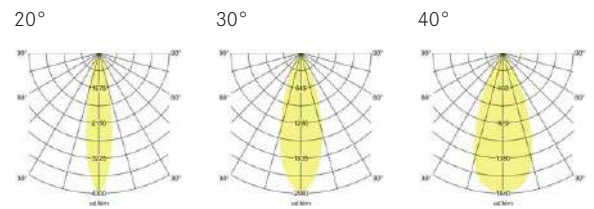

| Article no. textured silver | Article no. textured white | Article no. textured black | Beam angle | Colour temp. | Luminous flux | Colour rendering | System efficiency | Price in € |
|--------------------------------|-------------------------------|-------------------------------|---------------|-----------------|------------------|---------------------|----------------------|------------|
| 88842163 | 88842173 | 88842183 | 20° | 3,000 K | 3,545 lm | CRI > 90 | 127 lm/W | 172.90 |
| 88842165 | 88842175 | 88842185 | 20° | 3,500 K | 3,516 lm | CRI > 90 | 126 lm/W | 172.90 |
| 88842164 | 88842174 | 88842184 | 20° | 4,000 K | 3,589 lm | CRI > 90 | 128 lm/W | 172.90 |
| 88843163 | 88843173 | 88843183 | 30° | 3,000 K | 3,559 lm | CRI > 90 | 127 lm/W | 172.90 |
| 88843165 | 88843175 | 88843185 | 30° | 3,500 K | 3,544 lm | CRI > 90 | 127 lm/W | 172.90 |
| 88843164 | 88843174 | 88843184 | 30° | 4,000 K | 3,590 lm | CRI > 90 | 128 lm/W | 172.90 |
| 88844163 | 88844173 | 88844183 | 40° | 3,000 K | 3,710 lm | CRI > 90 | 132 lm/W | 172.90 |
| 88844165 | 88844175 | 88844185 | 40° | 3,500 K | 3,738 lm | CRI > 90 | 134 lm/W | 172.90 |
| 88844164 | 88844174 | 88844184 | 40° | 4,000 K | 3,711 lm | CRI > 90 | 133 lm/W | 172.90 |



These items are subject to discount group 1.



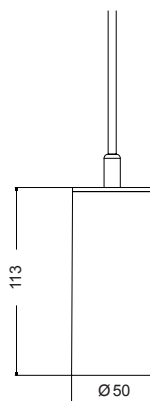

TRAXX MICRO LED pendant luminaire

Lamp: LED, incl. converter for 230 V mains voltage,
power: 9 W, control: switchable, material: aluminium / glass / plastic,
includes: operating unit, switchable, pendant length 1,500 mm

Service life:

L80/B50, 50,000 hrs. (ta: +25 °C)

30°

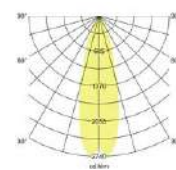

40°

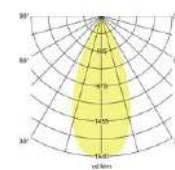

| Article no. textured silver | Article no. textured white | Article no. textured black | Beam angle | Colour temp. | Luminous flux | Colour rendering | System efficiency | Price in € |
|--------------------------------|-------------------------------|-------------------------------|---------------|-----------------|------------------|---------------------|----------------------|------------|
| 88853163 | 88853173 | 88853183 | 30° | 3,000 K | 1,081 lm | CRI>90 | 120 lm/W | 114.90 |
| 88853165 | 88853175 | 88853185 | 30° | 3,500 K | 1,093 lm | CRI>90 | 121 lm/W | 114.90 |
| 88853164 | 88853174 | 88853184 | 30° | 4,000 K | 1,101 lm | CRI>90 | 122 lm/W | 114.90 |
| 88854163 | 88854173 | 88854183 | 40° | 3,000 K | 1,080 lm | CRI>90 | 120 lm/W | 114.90 |
| 88854165 | 88854175 | 88854185 | 40° | 3,500 K | 1,085 lm | CRI>90 | 121 lm/W | 114.90 |
| 88854164 | 88854174 | 88854184 | 40° | 4,000 K | 1,093 lm | CRI>90 | 121 lm/W | 114.90 |
| 88856163 | 88856173 | 88856183 | 60° | 3,000 K | 1,092 lm | CRI>90 | 121 lm/W | 114.90 |
| 88856165 | 88856175 | 88856185 | 60° | 3,500 K | 1,099 lm | CRI>90 | 122 lm/W | 114.90 |
| 88856164 | 88856174 | 88856184 | 60° | 4,000 K | 1,107 lm | CRI>90 | 123 lm/W | 114.90 |

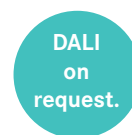

These items are subject to discount group 1.

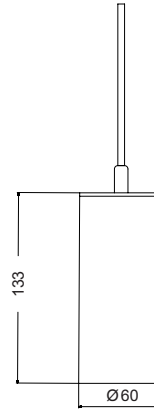

TRAXX MINI LED pendant luminaire

Lamp: LED, incl. converter for 230 V mains voltage, power: 14.5 W, control: switchable, material: aluminium / glass / plastic, includes: operating unit, switchable, pendant length 1,500 mm

Service life:

L80/B50, 50,000 hrs. (ta: +25 °C)

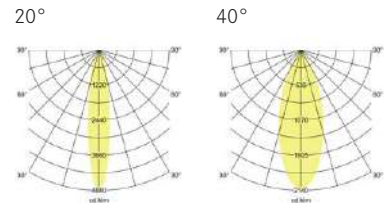

| Article no. textured silver | Article no. textured white | Article no. textured black | Beam angle | Colour temp. | Luminous flux | Colour rendering | System efficiency | Price in € |
|-----------------------------|----------------------------|----------------------------|------------|--------------|---------------|------------------|-------------------|------------|
| 88862163 | 88862173 | 88862183 | 20° | 3,000 K | 1,791 lm | CRI > 90 | 124 lm/W | 135.90 |
| 88862165 | 88862175 | 88862185 | 20° | 3,500 K | 1,785 lm | CRI > 90 | 123 lm/W | 135.90 |
| 88862164 | 88862174 | 88862184 | 20° | 4,000 K | 1,770 lm | CRI > 90 | 122 lm/W | 135.90 |
| 88864163 | 88864173 | 88864183 | 40° | 3,000 K | 1,846 lm | CRI > 90 | 127 lm/W | 135.90 |
| 88864165 | 88864175 | 88864185 | 40° | 3,500 K | 1,811 lm | CRI > 90 | 125 lm/W | 135.90 |
| 88864164 | 88864174 | 88864184 | 40° | 4,000 K | 1,822 lm | CRI > 90 | 126 lm/W | 135.90 |
| 88866163 | 88866173 | 88866183 | 60° | 3,000 K | 1,858 lm | CRI > 90 | 128 lm/W | 135.90 |
| 88866165 | 88866175 | 88866185 | 60° | 3,500 K | 1,833 lm | CRI > 90 | 126 lm/W | 135.90 |
| 88866164 | 88866174 | 88866184 | 60° | 4,000 K | 1,854 lm | CRI > 90 | 128 lm/W | 135.90 |

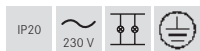

These items are subject to discount group 1.



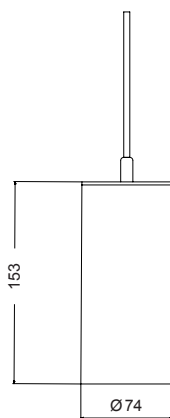

TRAXX MIDI LED pendant luminaire

Lamp: LED, incl. converter for 230 V mains voltage, power: 20 W, control: switchable, material: aluminium / glass / plastic, includes: operating unit, switchable, pendant length 1,500 mm

Service life:

L80/B50, 50,000 hrs. (ta: +25 °C)

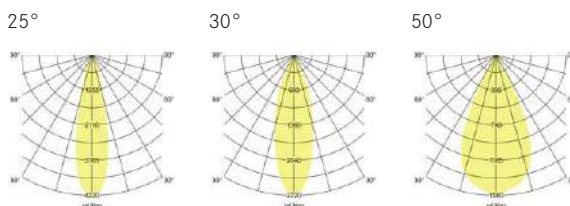

| Article no. textured silver | Article no. textured white | Article no. textured black | Beam angle | Colour temp. | Luminous flux | Colour rendering | System efficiency | Price in € |
|-----------------------------|----------------------------|----------------------------|------------|--------------|---------------|------------------|-------------------|------------|
| 88872163 | 88872173 | 88872183 | 25° | 3,000 K | 2,595 lm | CRI>90 | 130 lm/W | 175.90 |
| 88872165 | 88872175 | 88872185 | 25° | 3,500 K | 2,558 lm | CRI>90 | 128 lm/W | 175.90 |
| 88872164 | 88872174 | 88872184 | 25° | 4,000 K | 2,614 lm | CRI>90 | 131 lm/W | 175.90 |
| 88873163 | 88873173 | 88873183 | 30° | 3,000 K | 2,408 lm | CRI>90 | 120 lm/W | 175.90 |
| 88873165 | 88873175 | 88873185 | 30° | 3,500 K | 2,400 lm | CRI>90 | 120 lm/W | 175.90 |
| 88873164 | 88873174 | 88873184 | 30° | 4,000 K | 2,430 lm | CRI>90 | 122 lm/W | 175.90 |
| 88875163 | 88875173 | 88875183 | 50° | 3,000 K | 2,550 lm | CRI>90 | 128 lm/W | 175.90 |
| 88875165 | 88875175 | 88875185 | 50° | 3,500 K | 2,565 lm | CRI>90 | 128 lm/W | 175.90 |
| 88875164 | 88875174 | 88875184 | 50° | 4,000 K | 2,664 lm | CRI>90 | 133 lm/W | 175.90 |

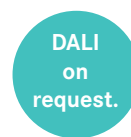

These items are subject to discount group 1.

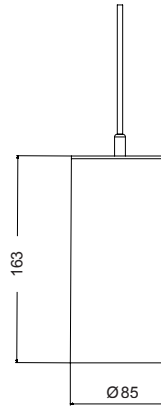

TRAXX MAXI LED pendant luminaire

Lamp: LED, incl. converter for 230 V mains voltage, power: 28 W, control: switchable, material: aluminium / glass / plastic, includes: operating unit, switchable, pendant length 1,500 mm

Service life:

L80/B50, 50,000 hrs. (ta: +25 °C)

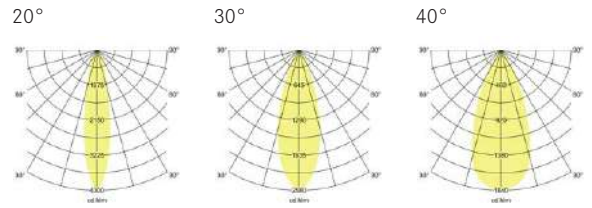

| Article no. textured silver | Article no. textured white | Article no. textured black | Beam angle | Colour temp. | Luminous flux | Colour rendering | System efficiency | Price in € |
|-----------------------------|----------------------------|----------------------------|------------|--------------|---------------|------------------|-------------------|------------|
| 88882163 | 88882173 | 88882183 | 20° | 3,000 K | 3,545 lm | CRI > 90 | 127 lm/W | 193.90 |
| 88882165 | 88882175 | 88882185 | 20° | 3,500 K | 3,516 lm | CRI > 90 | 126 lm/W | 193.90 |
| 88882164 | 88882174 | 88882184 | 20° | 4,000 K | 3,589 lm | CRI > 90 | 128 lm/W | 193.90 |
| 88883163 | 88883173 | 88883183 | 30° | 3,000 K | 3,559 lm | CRI > 90 | 127 lm/W | 193.90 |
| 88883165 | 88883175 | 88883185 | 30° | 3,500 K | 3,543 lm | CRI > 90 | 127 lm/W | 193.90 |
| 88883164 | 88883174 | 88883184 | 30° | 4,000 K | 3,590 lm | CRI > 90 | 128 lm/W | 193.90 |
| 88884163 | 88884173 | 88884183 | 40° | 3,000 K | 3,710 lm | CRI > 90 | 132 lm/W | 193.90 |
| 88884165 | 88884175 | 88884185 | 40° | 3,500 K | 3,738 lm | CRI > 90 | 134 lm/W | 193.90 |
| 88884164 | 88884174 | 88884184 | 40° | 4,000 K | 3,711 lm | CRI > 90 | 133 lm/W | 193.90 |

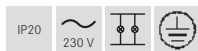

These items are subject to discount group 1.

LED LIGHTING
FUNDING

BEG



Luminous flux up to 5,713 lm
(size Maxi, 4,000 K)

Can be swivelled in and out flexibly.



ARTEMIS

LED recessed ceiling directional spotlights.

Innovative swivelling mechanism for targeted illumination.

The powerful and efficient ARTEMIS recessed directional spotlight scores with four installation sizes and can be flexibly swivelled in and out. It is also available in three to a maximum of 5 beam angles in three colour temperatures and a high colour rendering index (CRI > 90), making this spotlight an absolute all-rounder for almost any application.

Product advantages:

- 5-year Brumberg light guarantee.
- Long service life: L80B50 > 50,000 hours at +25 °C.
- High luminous efficacy: up to 138 lm / Watt.
- Four sizes available in up to five beam angles.

Quick configuration table:

| switchable | | | | | | | | |
|-----------------------|------------|-------|-----------------|----------------|----------------|--------------|---------|---------|
| | Beam angle | | Colour | | | Colour temp. | | |
| | | | Textured silver | Textured white | Textured black | 3,000 K | 3,500 K | 4,000 K |
| Micro 15 W | 24° | 88242 | 16 | 17 | 18 | 3 | 5 | 4 |
| | 40° | 88244 | 16 | 17 | 18 | 3 | 5 | 4 |
| | 60° | 88246 | 16 | 17 | 18 | 3 | 5 | 4 |
| Mini 27 W | 20° | 88252 | 16 | 17 | 18 | 3 | 5 | 4 |
| | 30° | 88253 | 16 | 17 | 18 | 3 | 5 | 4 |
| | 40° | 88254 | 16 | 17 | 18 | 3 | 5 | 4 |
| | 60° | 88256 | 16 | 17 | 18 | 3 | 5 | 4 |
| Midi 31.5 W | 25° | 88262 | 16 | 17 | 18 | 3 | 5 | 4 |
| | 37° | 88263 | 16 | 17 | 18 | 3 | 5 | 4 |
| | 60° | 88266 | 16 | 17 | 18 | 3 | 5 | 4 |
| Maxi 41.5 W | 12° | 88271 | 16 | 17 | 18 | 3 | 5 | 4 |
| | 20° | 88272 | 16 | 17 | 18 | 3 | 5 | 4 |
| | 30° | 88273 | 16 | 17 | 18 | 3 | 5 | 4 |
| | 40° | 88274 | 16 | 17 | 18 | 3 | 5 | 4 |
| | 60° | 88276 | 16 | 17 | 18 | 3 | 5 | 4 |
| | 1 | 2 | 3 | | | 4 | | |

Example: Maxi size with 40° beam angle in textured black with 4,000 K = art. no.: 88274184.

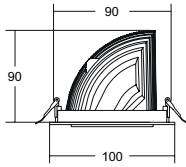

ARTEMIS MICRO LED recessed directional spotlight

Lamp: LED, colour rendering: CRI > 90, power: 15 W, rotatable and swivelling, control: switchable, material: aluminium / glass / plastic, incl. converter for connection to 230 V mains supply, switchable

20°

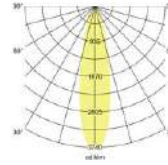

40°

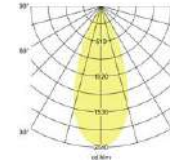

60°

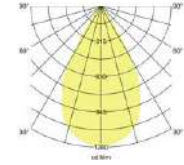

| Article no. textured silver | Article no. textured white | Article no. textured black | Beam angle | Colour rendering | Colour temp. | Luminous flux | System efficiency | Price in € |
|-----------------------------|----------------------------|----------------------------|------------|------------------|--------------|---------------|-------------------|------------|
| 88242163 | 88242173 | 88242183 | 20° | CRI>90 | 3,000 K | 1,806 lm | 120 lm/W | 109.90 |
| 88242165 | 88242175 | 88242185 | 20° | CRI>90 | 3,500 K | 1,800 lm | 120 lm/W | 109.90 |
| 88242164 | 88242174 | 88242184 | 20° | CRI>90 | 4,000 K | 1,800 lm | 120 lm/W | 109.90 |
| 88244163 | 88244173 | 88244183 | 40° | CRI>90 | 3,000 K | 1,820 lm | 121 lm/W | 109.90 |
| 88244165 | 88244175 | 88244185 | 40° | CRI>90 | 3,500 K | 1,800 lm | 120 lm/W | 109.90 |
| 88244164 | 88244174 | 88244184 | 40° | CRI>90 | 4,000 K | 1,800 lm | 120 lm/W | 109.90 |
| 88246163 | 88246173 | 88246183 | 60° | CRI>90 | 3,000 K | 1,800 lm | 120 lm/W | 109.90 |
| 88246165 | 88246175 | 88246185 | 60° | CRI>90 | 3,500 K | 1,800 lm | 120 lm/W | 109.90 |
| 88246164 | 88246174 | 88246184 | 60° | CRI>90 | 4,000 K | 1,800 lm | 120 lm/W | 109.90 |



These items are subject to discount group 1.

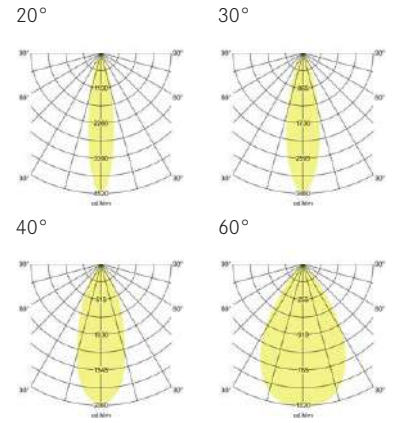
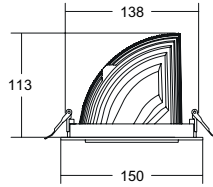

ARTEMIS MINI LED recessed directional spotlight

Lamp: LED, colour rendering: CRI > 90, power: 27 W, rotatable and swivelling, control: switchable, material: aluminium / glass / plastic, incl. converter for connection to 230 V mains supply, switchable

| Article no. textured silver | Article no. textured white | Article no. textured black | Beam angle | Colour rendering | Colour temp. | Luminous flux | System efficiency | Price in € |
|-----------------------------|----------------------------|----------------------------|------------|------------------|--------------|---------------|-------------------|------------|
| 88252163 | 88252173 | 88252183 | 20° | CRI>90 | 3,000 K | 3,719 lm | 138 lm/W | 129.90 |
| 88252165 | 88252175 | 88252185 | 20° | CRI>90 | 3,500 K | 3,681 lm | 136 lm/W | 129.90 |
| 88252164 | 88252174 | 88252184 | 20° | CRI>90 | 4,000 K | 3,733 lm | 138 lm/W | 129.90 |
| 88253163 | 88253173 | 88253183 | 30° | CRI>90 | 3,000 K | 3,571 lm | 132 lm/W | 129.90 |
| 88253165 | 88253175 | 88253185 | 30° | CRI>90 | 3,500 K | 3,592 lm | 133 lm/W | 129.90 |
| 88253164 | 88253174 | 88253184 | 30° | CRI>90 | 4,000 K | 3,690 lm | 137 lm/W | 129.90 |
| 88254163 | 88254173 | 88254183 | 40° | CRI>90 | 3,000 K | 3,719 lm | 138 lm/W | 129.90 |
| 88254165 | 88254175 | 88254185 | 40° | CRI>90 | 3,500 K | 3,698 lm | 137 lm/W | 129.90 |
| 88254164 | 88254174 | 88254184 | 40° | CRI>90 | 4,000 K | 3,752 lm | 139 lm/W | 129.90 |
| 88256163 | 88256173 | 88256183 | 60° | CRI>90 | 3,000 K | 3,519 lm | 130 lm/W | 129.90 |
| 88256165 | 88256175 | 88256185 | 60° | CRI>90 | 3,500 K | 3,467 lm | 128 lm/W | 129.90 |
| 88256164 | 88256174 | 88256184 | 60° | CRI>90 | 4,000 K | 3,521 lm | 130 lm/W | 129.90 |



These items are subject to discount group 1.

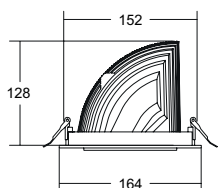

ARTEMIS MIDI LED recessed directional spotlight

Lamp: LED, colour rendering: CRI > 90, power: 31.5 W, rotatable and swivelling, control: switchable, material: aluminium / glass / plastic, incl. converter for connection to 230 V mains supply, switchable

20°

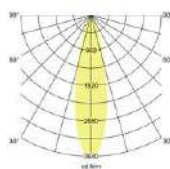

36°

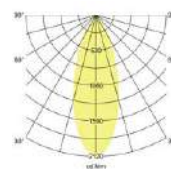

48°

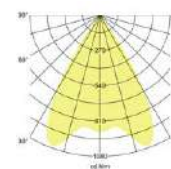

| Article no. textured silver | Article no. textured white | Article no. textured black | Beam angle | Colour rendering | Colour temp. | Luminous flux | System efficiency | Price in € |
|-----------------------------|----------------------------|----------------------------|------------|------------------|--------------|---------------|-------------------|------------|
| 88262163 | 88262173 | 88262183 | 25° | CRI>90 | 3,000 K | 3,849 lm | 122 lm/W | 149.90 |
| 88262165 | 88262175 | 88262185 | 25° | CRI>90 | 3,500 K | 3,815 lm | 121 lm/W | 149.90 |
| 88262164 | 88262174 | 88262184 | 25° | CRI>90 | 4,000 K | 3,851 lm | 122 lm/W | 149.90 |
| 88263163 | 88263173 | 88263183 | 37° | CRI>90 | 3,000 K | 3,960 lm | 126 lm/W | 149.90 |
| 88263165 | 88263175 | 88263185 | 37° | CRI>90 | 3,500 K | 3,924 lm | 125 lm/W | 149.90 |
| 88263164 | 88263174 | 88263184 | 37° | CRI>90 | 4,000 K | 3,962 lm | 126 lm/W | 149.90 |
| 88266163 | 88266173 | 88266183 | 60° | CRI>90 | 3,000 K | 3,933 lm | 125 lm/W | 149.90 |
| 88266165 | 88266175 | 88266185 | 60° | CRI>90 | 3,500 K | 3,861 lm | 123 lm/W | 149.90 |
| 88266164 | 88266174 | 88266184 | 60° | CRI>90 | 4,000 K | 3,880 lm | 123 lm/W | 149.90 |



These items are subject to discount group 1.

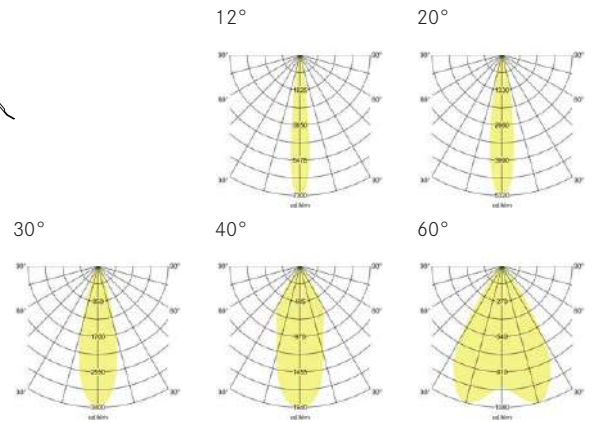
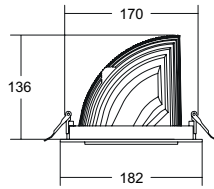

ARTEMIS MAXI LED recessed directional spotlight

Lamp: LED, colour rendering: CRI > 90, power: 41.5 W, rotatable and swivelling, control: switchable, material: aluminium / glass / plastic, incl. converter for connection to 230 V mains supply, switchable

| Article no. textured silver | Article no. textured white | Article no. textured black | Beam angle | Colour rendering | Colour temp. | Luminous flux | System efficiency | Price in € |
|-----------------------------|----------------------------|----------------------------|------------|------------------|--------------|---------------|-------------------|------------|
| 88271163 | 88271173 | 88271183 | 12° | CRI>90 | 3,000 K | 5,174 lm | 125 lm/W | 169.90 |
| 88271165 | 88271175 | 88271185 | 12° | CRI>90 | 3,500 K | 5,279 lm | 127 lm/W | 169.90 |
| 88271164 | 88271174 | 88271184 | 12° | CRI>90 | 4,000 K | 5,139 lm | 124 lm/W | 169.90 |
| 88272163 | 88272173 | 88272183 | 20° | CRI>90 | 3,000 K | 5,243 lm | 126 lm/W | 169.90 |
| 88272165 | 88272175 | 88272185 | 20° | CRI>90 | 3,500 K | 5,291 lm | 127 lm/W | 169.90 |
| 88272164 | 88272174 | 88272184 | 20° | CRI>90 | 4,000 K | 5,199 lm | 125 lm/W | 169.90 |
| 88273163 | 88273173 | 88273183 | 30° | CRI>90 | 3,000 K | 5,316 lm | 128 lm/W | 169.90 |
| 88273165 | 88273175 | 88273185 | 30° | CRI>90 | 3,500 K | 5,346 lm | 129 lm/W | 169.90 |
| 88273164 | 88273174 | 88273184 | 30° | CRI>90 | 4,000 K | 5,259 lm | 127 lm/W | 169.90 |
| 88274163 | 88274173 | 88274183 | 40° | CRI>90 | 3,000 K | 5,264 lm | 127 lm/W | 169.90 |
| 88274165 | 88274175 | 88274185 | 40° | CRI>90 | 3,500 K | 5,264 lm | 127 lm/W | 169.90 |
| 88274164 | 88274174 | 88274184 | 40° | CRI>90 | 4,000 K | 5,180 lm | 125 lm/W | 169.90 |
| 88276163 | 88276173 | 88276183 | 60° | CRI>90 | 3,000 K | 5,459 lm | 132 lm/W | 169.90 |
| 88276165 | 88276175 | 88276185 | 60° | CRI>90 | 3,500 K | 5,420 lm | 131 lm/W | 169.90 |
| 88276164 | 88276174 | 88276184 | 60° | CRI>90 | 4,000 K | 5,343 lm | 129 lm/W | 169.90 |



These items are subject to discount group 1.



RETAIL ONE

LED track spotlights.

High system efficiency for a purposeful product presentation.

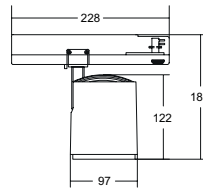

RETAIL ONE LED track spotlights

NEW

Lamp: LED, input voltage: 220-240 V AC, 50-60 Hz, power: 33.5 W, beam angle: 40°, material: aluminium, includes: operating unit, switchable

Service life:

L80/B50, 50,000 hrs. (ta: +25 °C)

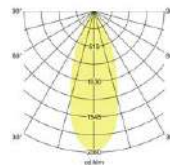

| Article no. | Colour | Luminous flux | Colour temp. | Colour rendering | System efficiency | Price in € |
|-------------|-----------------|---------------|--------------|------------------|-------------------|------------|
| 88184163 | textured silver | 4,332 lm | 3,000 K | CRI > 90 | 129 lm/W | 129.90 |
| 88184165 | textured silver | 4,319 lm | 3,500 K | CRI > 90 | 129 lm/W | 129.90 |
| 88184164 | textured silver | 4,269 lm | 4,000 K | CRI > 90 | 127 lm/W | 129.90 |
| 88184173 | textured white | 4,332 lm | 3,000 K | CRI > 90 | 129 lm/W | 129.90 |
| 88184175 | textured white | 4,319 lm | 3,500 K | CRI > 90 | 129 lm/W | 129.90 |
| 88184174 | textured white | 4,269 lm | 4,000 K | CRI > 90 | 127 lm/W | 129.90 |
| 88184183 | textured black | 4,332 lm | 3,000 K | CRI > 90 | 129 lm/W | 129.90 |
| 88184185 | textured black | 4,319 lm | 3,500 K | CRI > 90 | 129 lm/W | 129.90 |
| 88184184 | textured black | 4,269 lm | 4,000 K | CRI > 90 | 127 lm/W | 129.90 |

Other beam angles on request.



These items are subject to discount group 1.

LED LIGHTING
FUNDING

BEG

DALI
on
request.

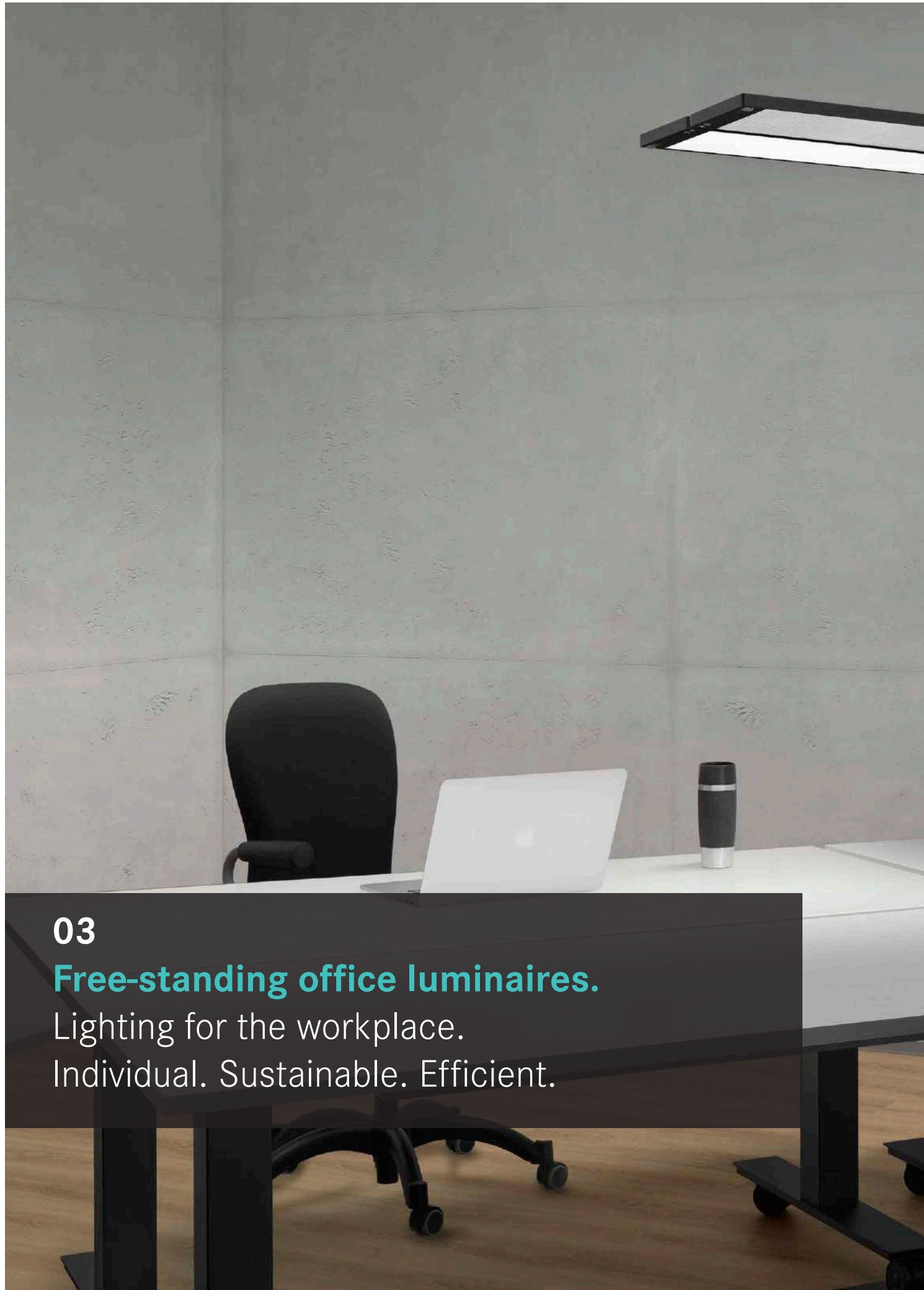

03

Free-standing office luminaires.

Lighting for the workplace.

Individual. Sustainable. Efficient.



THIS IS WHAT WINNERS LOOK LIKE: GERMAN DESIGN AWARD

2024.

The German Design Award is the premium prize of the German Design Council. With its global scope and international appeal, it is one of the most prestigious awards in the design landscape across all industries. Since 2012, the German Design Award has been identifying key design trends, presenting them to a broad public and honouring them.



GERMAN DESIGN AWARD WINNER 2024

Winner MELODY.

Our MELODY LED free-standing luminaire was honoured with the WINNER award at the German Design Award 2024. MELODY is characterised by its straightforward design and is an absolute eye-catcher in modern and classic offices. It combines individuality and flexibility, accompanies your own working rhythm and

offers the right light for every situation – always in harmony with your own workflow. Future-proof lighting is not only adaptive, it is also sustainable, durable and customised. Its outstanding "Made in Germany" material quality makes MELODY a particularly high-quality and durable luminaire.

MELODY.

MY
EFFICIENT
LIGHT
ON
DEMAND

Everyone follows their own rhythm in life – even at work. To make room for these different rhythms, new forms of work have replaced the traditional ones.

Lighting that harmoniously supports individual processes with perfectly harmonised light and offers individuality and flexibility is essential for a modern working environment. It (melodically) accompanies your own working rhythm, illuminates it in a harmonised way and can be changed in line with your own workflow.

This is **MELODY** – my efficient light on demand – year round.

Product advantages:

- Nanoprismatic optics for low glare UGR < 19.
- Colour rendering of CRI > 90.
- Customisable from 1 to 4 heads.
- Controllable via Casambi.
- Separately controllable direct / indirect.
- High efficiency with 126 lm/W.
- Service life > 50,000 at ta 25 °C, L90B10.
- Presence detector on the luminaire head.
- **Luminance < 3000 cd / m²**

The Award.

The German Design Council Foundation has been operating as the world's leading institution for communication and knowledge transfer in the fields of design, brand and innovation since 1953. With international programmes, talent promotion and memberships, it is part of the global design community and has always contributed to establishing exchange and networks worldwide. Through events, congresses, competitions, jury meetings and expert groups, the German Design Council Foundation networks its members and numerous other international design and brand experts, promotes discourse and provides important impetus for the global economy. Its members currently include more than 330 companies.

light follows rhythm



Precise atmosphere for the workplace

MELODY offers maximum individuality. Each user can set their optimum lighting atmosphere depending on the work situation. Whether you need soft light for a video call or plenty of light for a concentrated brainstorming session – with MELODY you always enjoy perfect lighting conditions.

It doesn't matter whether you work alone or in a group. MELODY can be individually controlled and offers the right light for every need and every biorhythm.

This ensures well-being, creates efficiency and makes everyday working life even smarter thanks to intuitive operation. Even the direct and indirect light components can be dimmed and controlled separately – perfect for working at a computer screen.

MELODY also automatically adapts to the ambient light – for maximum precision light adjustment that is exclusively orientated to the needs of the person.

Quick configuration table:

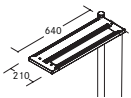
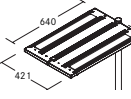
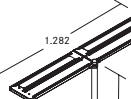
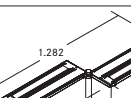
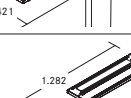
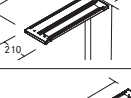
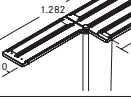
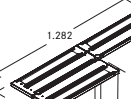
| Sketch | | | | switchable | | | | MS = with sensor | ST = sensor + button | AI = sensor + button + app |
|---|-------------------------------|-------|----------|----------------|-------------------|--------------------|-----------------|------------------------|----------------------------|-------------------------------------|
| | | | | Colour | | | Colour temp. | | | |
| | | | | Textured white | Textured black | Textured silver | 4,000 K | | | |
|  | 1-head | 60 W | 77411 | 17 | 18 | 69 | 4 | MS | ST | AI |
|  | 2-head parallel | 120 W | 77412 | 17 | 18 | 69 | 4 | MS | ST | AI |
|  | 2-head linear | | 77422 | 17 | 18 | 69 | 4 | MS | ST | AI |
|  | 2-head diagonally left | | 77432 | 17 | 18 | 69 | 4 | MS | ST | AI |
|  | 2-head diagonally right | | 77442 | 17 | 18 | 69 | 4 | MS | ST | AI |
|  | 3-head right | | 180 W | 77413 | 17 | 18 | 69 | 4 | MS | ST |
|  | 3-head left | 77423 | | 17 | 18 | 69 | 4 | MS | ST | AI |
|  | 4-head | 240 W | 77414 | 17 | 18 | 69 | 4 | MS | ST | AI |
| | 1 | | 2 | 3 | | | 4 | 5 | | |

Example:

2-head linear version in textured silver with 4,000 K with sensor & button = art. no.: 77422 69 4 ST

light to handle

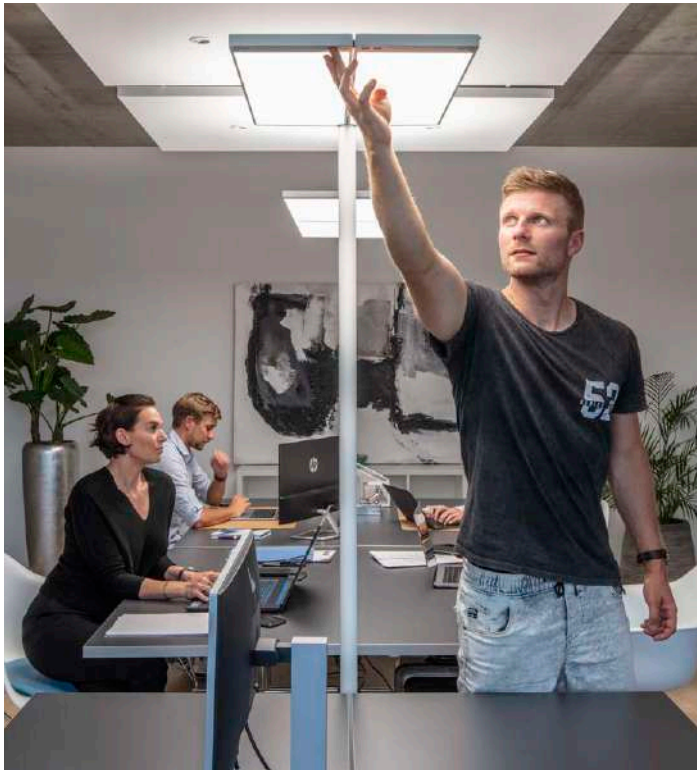
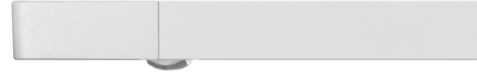

Depending on the version ordered with

- Brightness and presence detectors
- Brightness and presence detectors + manual control via illuminated touch sensor
- APP control + brightness and presence detectors + manual control via illuminated touch sensor
- EnOcean button (not included in the scope of supply)

Lighting control in the blink of an eye.

MELODY ensures maximum convenience – even during operation. There are four different operating concepts to choose from, enabling simple and optimised lighting control – to suit every individual requirement.

1. Button on the luminaire head

With manual control, you operate MELODY in the classic way using a switch on the luminaire head. The light intensity can be adjusted directly/indirectly for the respective lighting situation. The booster function allows the light to be manually overridden for increased visual tasks.

2. Sensor control

Thanks to the sensor control including presence detector, MELODY reacts automatically to external influences, such as daylight or moving people, and adjusts the light accordingly. This makes particularly efficient use of available ambient light, but also avoids unnecessary lighting when people are absent.

3. MELODY App

The free app belonging to MELODY works with a Casambi module. It works with both iOS and Android devices and offers numerous options for customised control.

4. EnOcean button

MELODY including app can also be controlled with battery-free Casambi wireless switches. The so-called Casambi-compatible EnOcean buttons can be placed like regular switches. They work kinetically, i.e. they use kinetic energy to transmit radio signals and are therefore battery- and maintenance-free.

Ultra-flat design.
19 mm luminaire head for
separately switchable
direct and indirect light

Individual
control
via button

Automatic control
via presence detector
and daylight sensor



APP control

Modularly expandable:
stand tube for holding
1 to 4 luminaire
heads

Innovative cloud technology:
the dynamically adjusted engraving
density and depth of the LED module
ensure optimum and efficient light
distribution across the entire surface of
the luminaire.

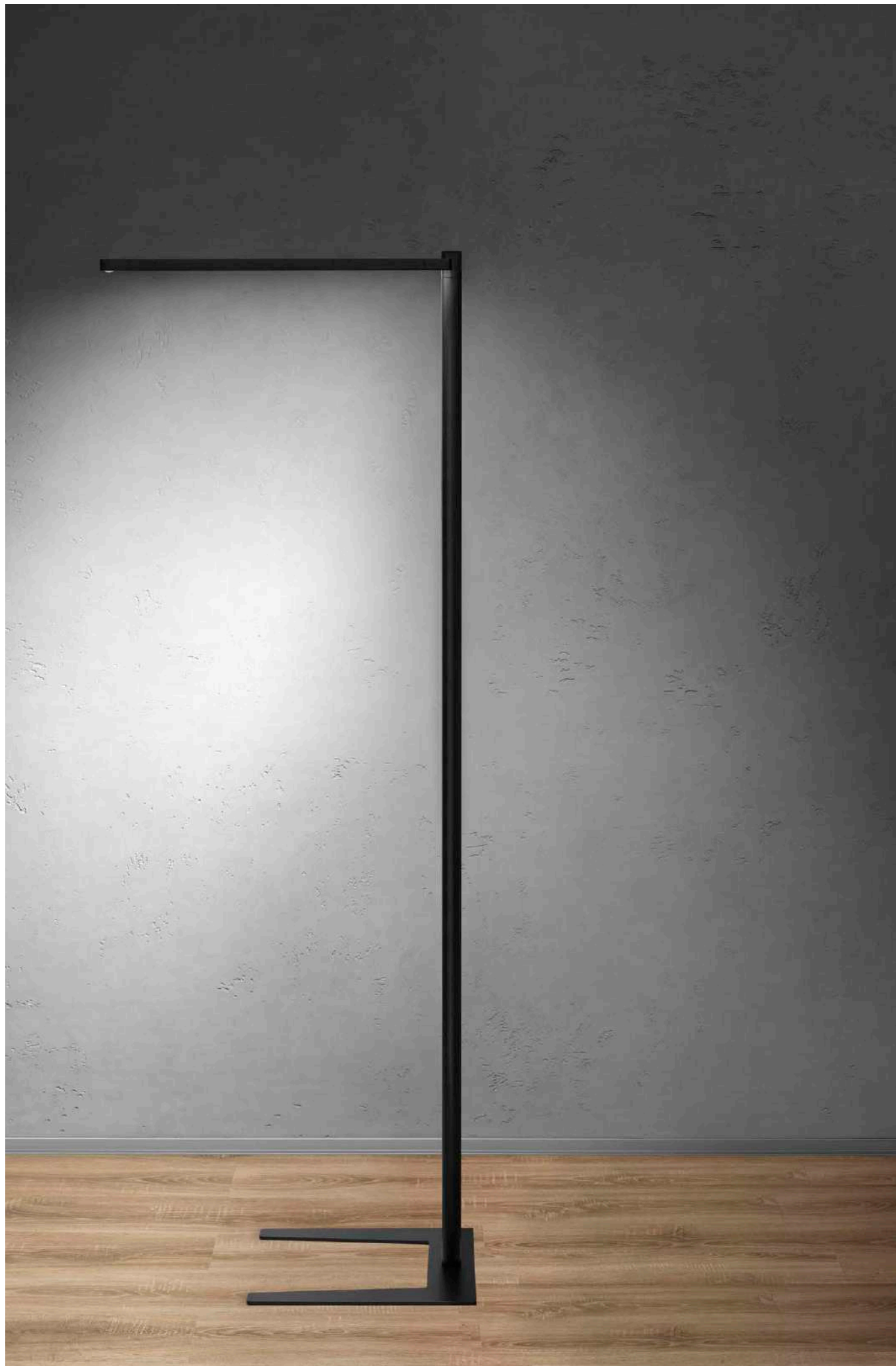

MELODY LED free-standing luminaire, 1-head NEW

Lamp: LED, colour rendering: CRI > 90, colour temperature: 4,000 K, power: 60 W, complete luminous flux (direct+indirect 100%): 7,600 lm, luminous flux direct (17 %): 1,292 lm, luminous flux indirect (83 %): 6,308 lm, glare rating: UGR < 19, system efficiency: 127 W/m, material: aluminium / steel / plastic, optics: nanoprisms (direct) / microprisms (indirect), light distribution: double asymmetrical, control: daylight sensor / presence detector, dimming via integrated button, includes: 2,500 mm supply cable with angled protective plug

Service life:

L90/B10, 50,000 hrs. (ta: +25 °C)



textured white
RAL 9016

textured black
RAL 9005

textured silver
RAL 9006

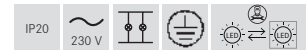
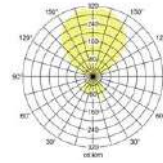

These items are subject to discount group 2.

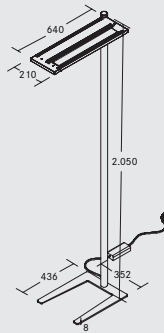

| Article no. | Colour | Price in € |
|-------------|-----------------|------------|
| 77411174MS | textured white | 1829.00 |
| 77411184MS | textured black | 1829.00 |
| 77411694MS | textured silver | 1829.00 |
| 77411174ST | textured white | 1929.00 |
| 77411184ST | textured black | 1929.00 |
| 77411694ST | textured silver | 1929.00 |
| 77411174AI | textured white | 2049.00 |
| 77411184AI | textured black | 2049.00 |
| 77411694AI | textured silver | 2049.00 |

Ending MS:
with sensor

Ending ST:
with sensor
and button

Ending AI:
with sensor, button
and app



MELODY LED free-standing luminaire, 2-head NEW

Lamp: LED, colour rendering: CRI > 90, colour temperature: 4,000 K, power: 120 W, complete luminous flux (direct+indirect 100%): 15,200 lm, luminous flux direct (17 %): 2,584 lm, luminous flux indirect (83 %): 12,616 lm, glare rating: UGR < 19, system efficiency: 127 W/m, material: aluminium / steel / plastic, optics: nanoprisms (direct) / microprisms (indirect), light distribution: double asymmetrical, control: daylight sensor / presence detector, dimming via integrated button, includes: 2,500 mm supply cable with angled protective plug

Service life:

L90/B10, 50,000 hrs. (ta: +25 °C)

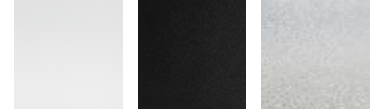

textured white
RAL 9016

textured black
RAL 9005

textured silver
RAL 9006

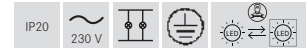
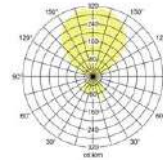

These items are subject to discount group 2.

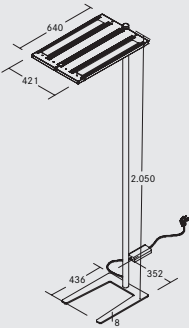



| Article no. | Colour | Price in € |
|-------------|-----------------|------------|
| 77412174MS | textured white | 2999.00 |
| 77412184MS | textured black | 2999.00 |
| 77412694MS | textured silver | 2999.00 |
| 77412174ST | textured white | 3249.00 |
| 77412184ST | textured black | 3249.00 |
| 77412694ST | textured silver | 3249.00 |
| 77412174AI | textured white | 3439.00 |
| 77412184AI | textured black | 3439.00 |
| 77412694AI | textured silver | 3439.00 |

Ending MS: with sensor

Ending ST: with sensor and button

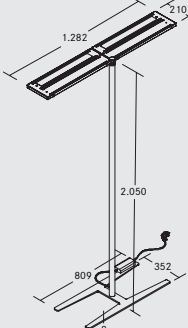
Ending AI: with sensor, button and app

| Article no. | Colour | Price in € |
|-------------|-----------------|------------|
| 77422174MS | textured white | 2999.00 |
| 77422184MS | textured black | 2999.00 |
| 77422694MS | textured silver | 2999.00 |
| 77422174ST | textured white | 3249.00 |
| 77422184ST | textured black | 3249.00 |
| 77422694ST | textured silver | 3249.00 |
| 77422174AI | textured white | 3439.00 |
| 77422184AI | textured black | 3439.00 |
| 77422694AI | textured silver | 3439.00 |

Ending MS: with sensor

Ending ST: with sensor and button

Ending AI: with sensor, button and app





| Article no. | Colour | Price in € |
|-------------|-----------------|------------|
| 77432174MS | textured white | 2999.00 |
| 77432184MS | textured black | 2999.00 |
| 77432694MS | textured silver | 2999.00 |
| 77432174ST | textured white | 3249.00 |
| 77432184ST | textured black | 3249.00 |
| 77432694ST | textured silver | 3249.00 |
| 77432174AI | textured white | 3439.00 |
| 77432184AI | textured black | 3439.00 |
| 77432694AI | textured silver | 3439.00 |

Ending MS: with sensor

Ending ST: with sensor and button

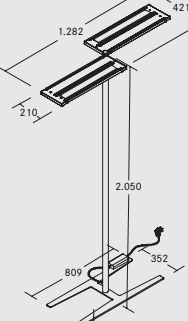
Ending AI: with sensor, button and app

| Article no. | Colour | Price in € |
|-------------|-----------------|------------|
| 77442174MS | textured white | 2999.00 |
| 77442184MS | textured black | 2999.00 |
| 77442694MS | textured silver | 2999.00 |
| 77442174ST | textured white | 3249.00 |
| 77442184ST | textured black | 3249.00 |
| 77442694ST | textured silver | 3249.00 |
| 77442174AI | textured white | 3439.00 |
| 77442184AI | textured black | 3439.00 |
| 77442694AI | textured silver | 3439.00 |

Ending MS: with sensor

Ending ST: with sensor and button

Ending AI: with sensor, button and app



MELODY LED free-standing luminaire, 3-head NEW

Lamp: LED, colour rendering: CRI > 90, colour temperature: 4,000 K, power: 180 W, complete luminous flux (direct+indirect 100%): 22,800 lm, luminous flux direct (17 %): 3,867 lm, luminous flux indirect (83 %): 18,924 lm, glare rating: UGR < 19, system efficiency: 127 W/m, material: aluminium / steel / plastic, optics: nanoprisms (direct) / microprisms (indirect), light distribution: double asymmetrical, control: daylight sensor / presence detector, dimming via integrated button, includes: 2,500 mm supply cable with angled protective plug

Service life:

L90/B10, 50,000 hrs. (ta: +25 °C)

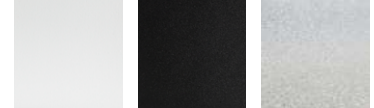

textured white RAL 9016 textured black RAL 9005 textured silver RAL 9006

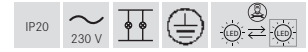
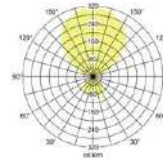

These items are subject to discount group 2.

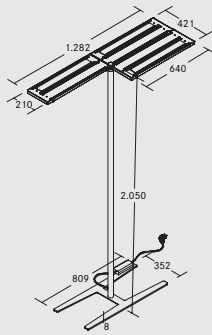

| Article no. | Colour | Price in € |
|-------------|-----------------|------------|
| 77413174MS | textured white | 4099.00 |
| 77413184MS | textured black | 4099.00 |
| 77413694MS | textured silver | 4099.00 |
| 77413174ST | textured white | 4479.00 |
| 77413184ST | textured black | 4479.00 |
| 77413694ST | textured silver | 4479.00 |
| 77413174AI | textured white | 4769.00 |
| 77413184AI | textured black | 4769.00 |
| 77413694AI | textured silver | 4769.00 |

Ending MS:
with sensor

Ending ST:
with sensor and button

Ending AI:
with sensor, button
and app

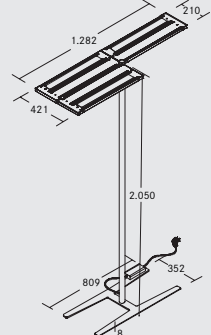

| Article no. | Colour | Price in € |
|-------------|-----------------|------------|
| 77423174MS | textured white | 4099.00 |
| 77423184MS | textured black | 4099.00 |
| 77423694MS | textured silver | 4099.00 |
| 77423174ST | textured white | 4479.00 |
| 77423184ST | textured black | 4479.00 |
| 77423694ST | textured silver | 4479.00 |
| 77423174AI | textured white | 4769.00 |
| 77423184AI | textured black | 4769.00 |
| 77423694AI | textured silver | 4769.00 |

Ending MS:
with sensor

Ending ST:
with sensor and button

Ending AI:
with sensor, button
and app

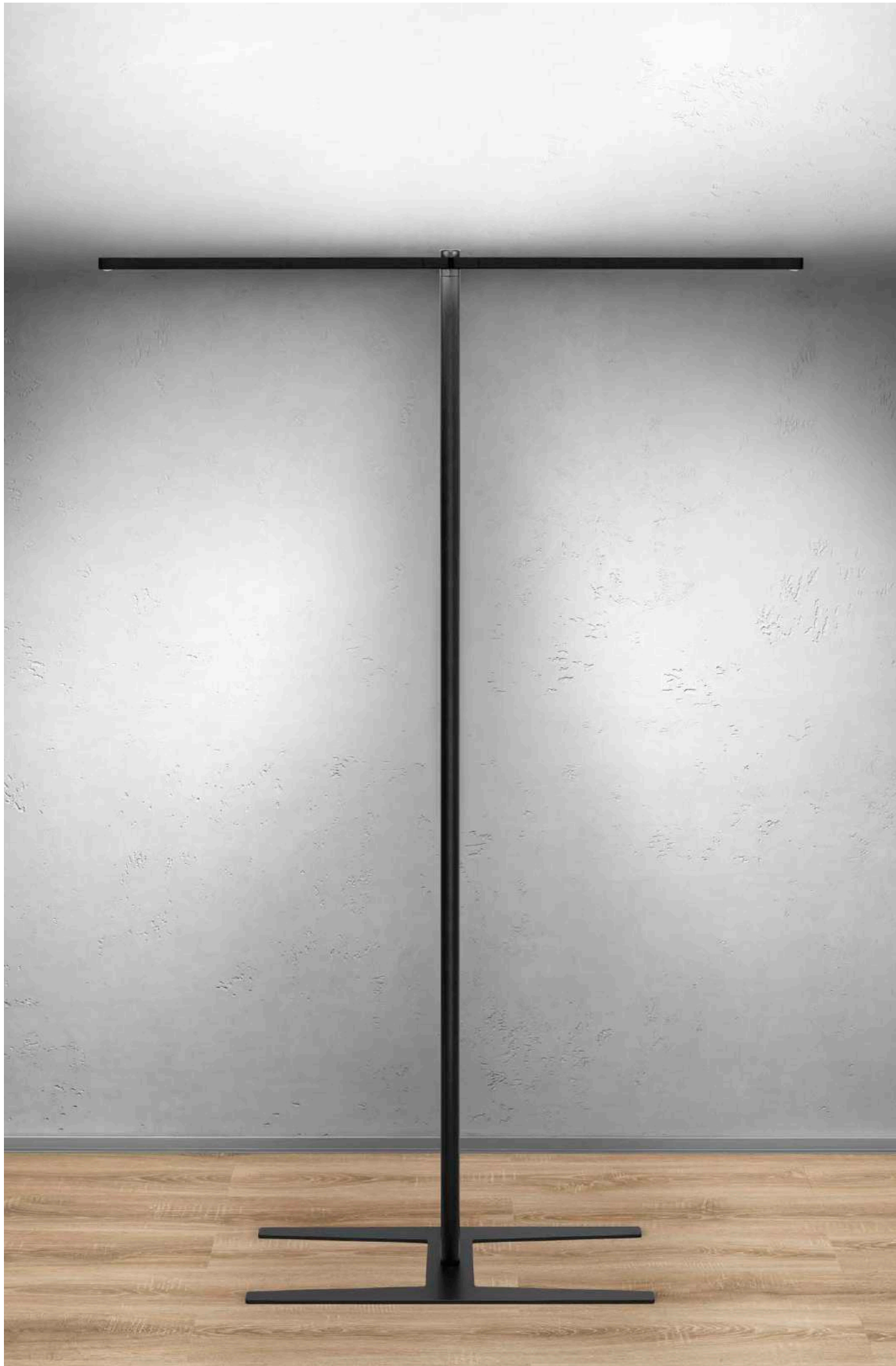

MELODY LED free-standing luminaire, 4-head NEW

Lamp: LED, colour rendering: CRI > 90, colour temperature: 4,000 K, power: 240 W, complete luminous flux (direct+indirect 100%): 30,400 lm, luminous flux direct (17 %): 5,168 lm, luminous flux indirect (83 %): 25,232 lm, glare rating: UGR < 19, system efficiency: 127 W/m, material: aluminium / steel / plastic, optics: nanoprisms (direct) / microprisms (indirect), light distribution: double asymmetrical, control: daylight sensor / presence detector, dimming via integrated button, includes: 2,500 mm supply cable with angled protective plug

Service life:

L90/B10, 50,000 hrs. (ta: +25 °C)



textured white
RAL 9016

textured black
RAL 9005

textured silver
RAL 9006

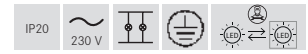
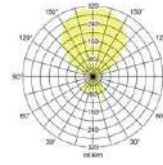

These items are subject to discount group 2.

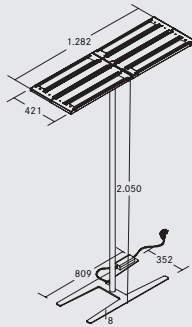

| Article no. | Colour | Price in € |
|-------------|-----------------|------------|
| 77414174MS | textured white | 5199.00 |
| 77414184MS | textured black | 5199.00 |
| 77414694MS | textured silver | 5199.00 |
| 77414174ST | textured white | 5699.00 |
| 77414184ST | textured black | 5699.00 |
| 77414694ST | textured silver | 5699.00 |
| 77414174AI | textured white | 6099.00 |
| 77414184AI | textured black | 6099.00 |
| 77414694AI | textured silver | 6099.00 |

Ending MS:
with sensor

Ending ST:
with sensor and
button

Ending AI:
with sensor, button
and app

efficient workspace light



Efficient. Qualitative. Eligible for subsidies.

Precise lighting is good. High-quality, efficient, precise lighting is better. The "Made in Germany" MELODY offers a luminous efficacy of 126 lm/W and is therefore not only extremely efficient, but also eligible for subsidies*. With this value, the free-standing luminaire is suitable for the "Federal Funding for Efficient Buildings", for example.

Efficient

Thanks to its high luminous efficacy of 126 lm/W, MELODY is particularly efficient and therefore climate-friendly. This allows you to save large amounts of valuable energy.

Eligible for subsidies*

Your investment in climate-friendly lighting is supported because MELODY is eligible for subsidies and therefore saves you money.

Made in Germany

Its outstanding "Made in Germany" material quality makes MELODY a particularly high-quality and durable luminaire. Short delivery routes protect the environment.

Cradle-to-cradle**

We are currently well on the way to achieving cradle-to-cradle certification. Many milestones have already been reached so that our luminaire will soon be certified.

*For this purpose, the luminaire must be an integral part of the building and connected to the building via the supply line in the distribution or mechanically via a base plate.

** The known cradle-to-cradle principle describes an integrated and consistent circular economy. In this process, products are broken down into pure source materials after use, whereby the material quality is retained and returned to technical cycles. In this way, valuable resources can be saved, waste avoided and the environment protected.



Convertible

MELODY cuts a fine figure in any place and in any style of furnishing. It is durable, easy to transport and can be set up quickly for flexible room utilisation. It can also be upgraded on a modular basis to meet changing work situations.



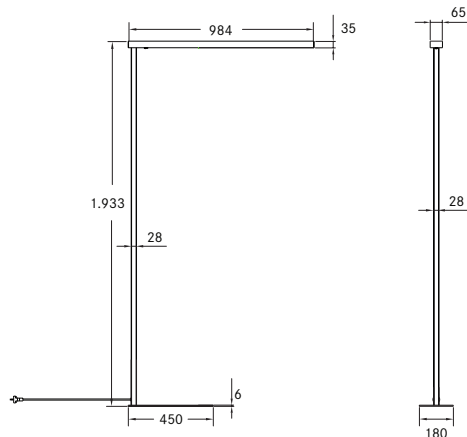
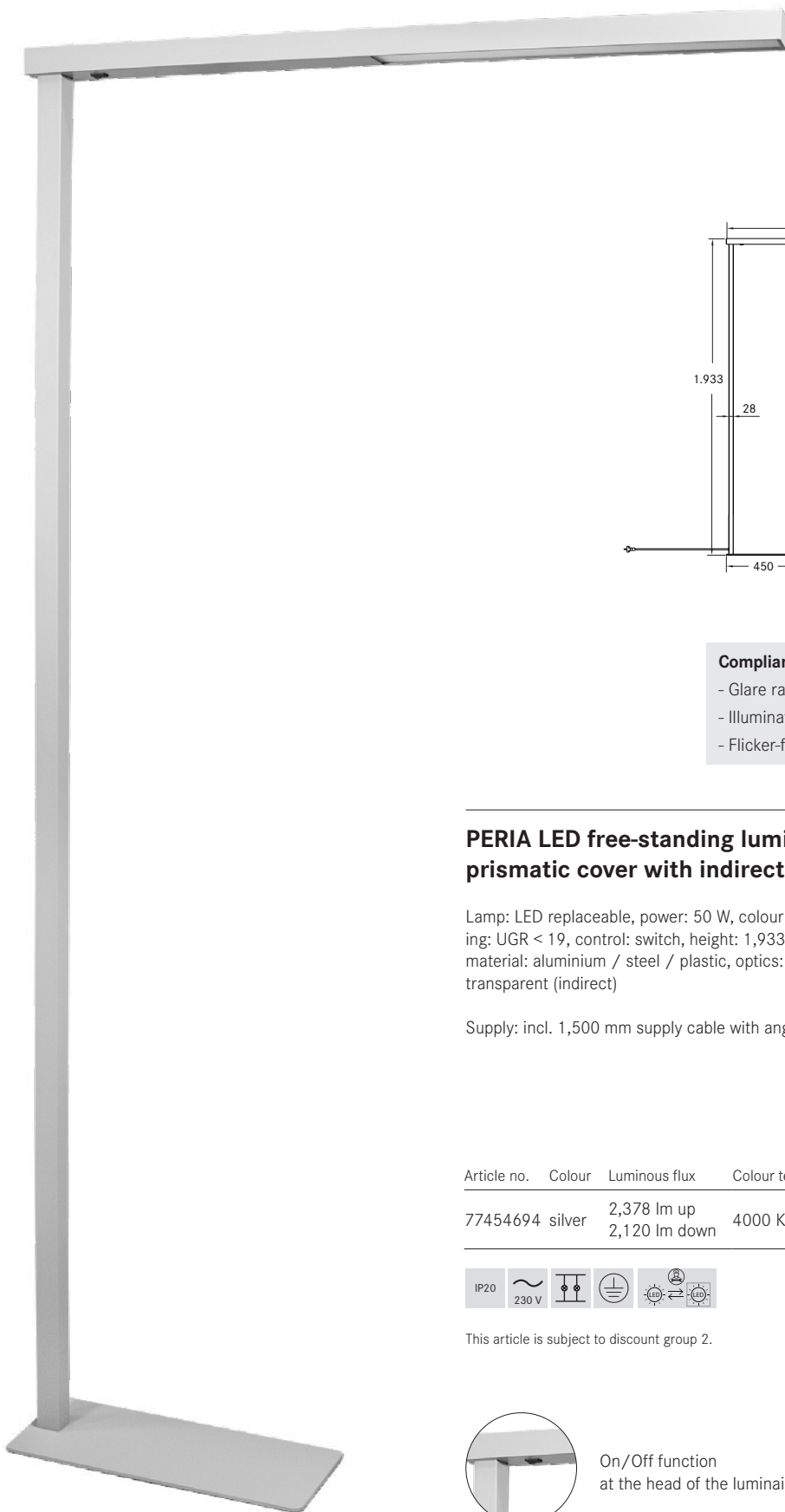

Compliant with workplace regulations:

- Glare rating UGR < 19.
- Illumination intensity at least 500 Lux.
- Flicker-free light.

PERIA LED free-standing luminaire, micro-prismatic cover with indirect light component

NEW

Lamp: LED replaceable, power: 50 W, colour rendering: CRI > 80, glare rating: UGR < 19, control: switch, height: 1,933 mm, material: aluminium / steel / plastic, optics: microprisms (direct) / transparent (indirect)

Supply: incl. 1,500 mm supply cable with angled protective plug

| Article no. | Colour | Luminous flux | Colour temp. | System efficiency | Price in € |
|-------------|--------|------------------------------|--------------|-------------------|------------|
| 77454694 | silver | 2,378 lm up 2,120 lm down | 4000 K | 88 lm/W | 629.90 |

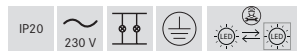

This article is subject to discount group 2.



On/Off function at the head of the luminaire.

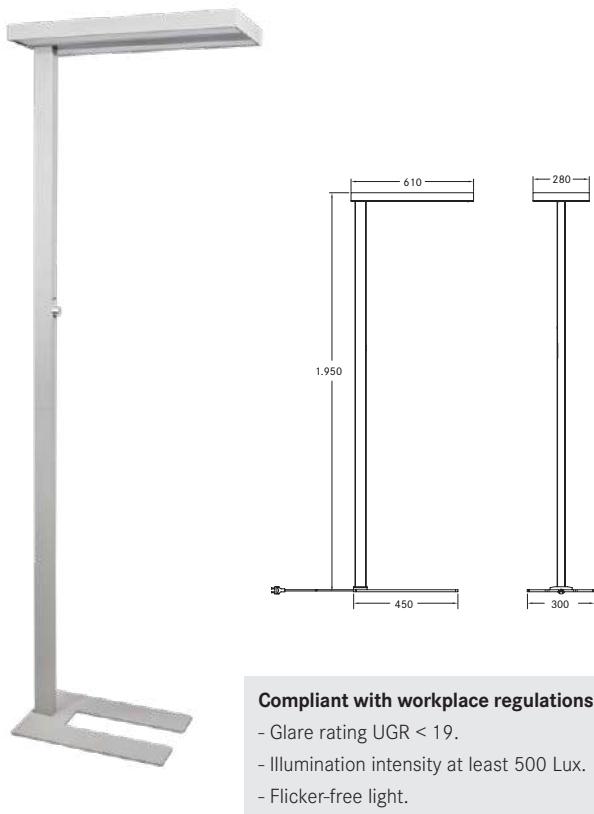

Compliant with workplace regulations:

- Glare rating UGR < 19.
- Illumination intensity at least 500 Lux.
- Flicker-free light.

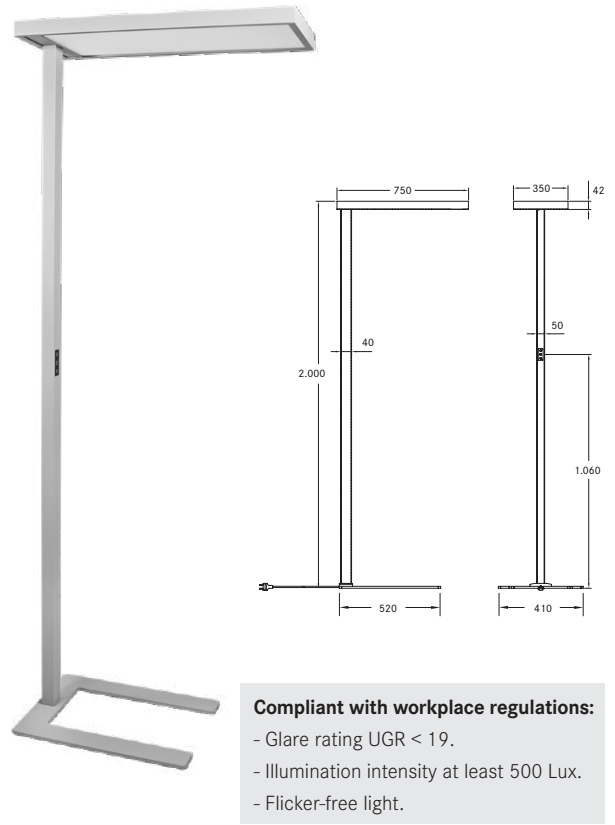

Compliant with workplace regulations:

- Glare rating UGR < 19.
- Illumination intensity at least 500 Lux.
- Flicker-free light.

ADREA LED free-standing luminaire, micro-prismatic cover with indirect light component NEW

Lamp: LED replaceable, power: 60 W, colour rendering: CRI > 80, glare rating: UGR < 19, control: rotary dimmer, height: 1,950 mm, material: aluminium / steel / plastic, optics: microprisms (direct) / transparent (indirect)

Supply: incl. 1,500 mm supply cable with angled protective plug.

| Article no. | Colour | Luminous flux | Colour temp. | System efficiency | Price in € |
|-------------|--------|------------------------------|--------------|-------------------|------------|
| 77450694 | silver | 3,600 lm up 2,400 lm down | 4000 K | 102 lm/W | 829.90 |



This item is subject to discount group 2.



Direct and indirect dimmable together with rotary dimmer directly at the luminaire.

DEVAN LED free-standing luminaire, micro-prismatic cover with indirect light component NEW

Lamp: LED not replaceable, power: 96 W, colour rendering: CRI > 80, glare rating: UGR < 19, control: touch dimmer, height: 2,000 mm, material: aluminium / steel / plastic, optics: microprisms (direct) / transparent (indirect)

Supply: incl. 1,500 mm supply cable with angled protective plug.

| Article no. | Colour | Luminous flux | Colour temp. | System efficiency | Price in € |
|-------------|--------|------------------------------|--------------|-------------------|------------|
| 77452694 | silver | 6,500 lm up 5,000 lm down | 4000 K | 122 lm/W | 1599.90 |

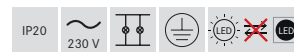

This item is subject to discount group 2.



Direct and indirect dimmable separately with button directly at the luminaire.

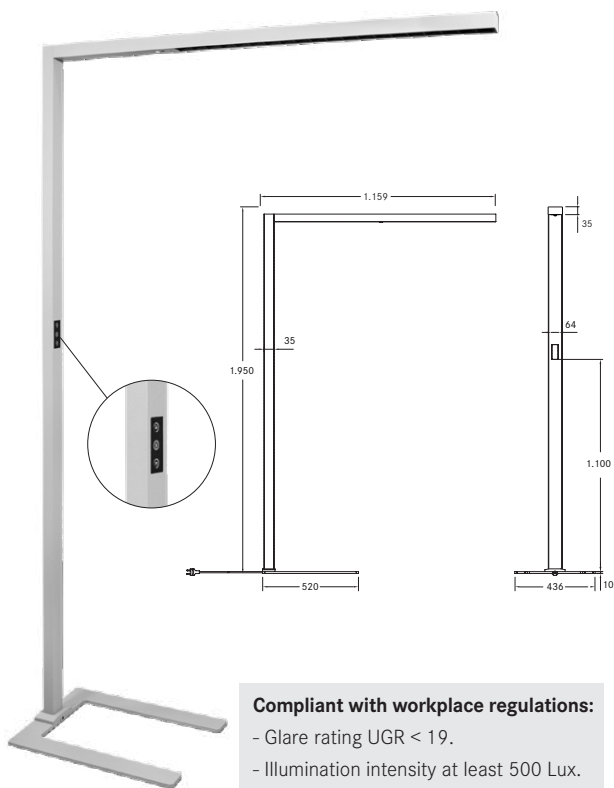

Compliant with workplace regulations:

- Glare rating UGR < 19.
- Illumination intensity at least 500 Lux.
- Flicker-free light.

BEVON LED free-standing luminaire, micro-prismatic cover with indirect light component NEW

Lamp: LED not replaceable, power: 70 W, colour rendering: CRI > 80, glare rating: UGR < 6, control: touch dimmer, height: 1,950 mm, material: aluminium / steel / plastic, optics: micro cell grid (direct) / transparent (indirect)

Supply: incl. 1,500 mm supply cable with angled protective plug

| Article no. | Colour | Luminous flux | Colour temp. | System efficiency | Price in € |
|-------------|--------|------------------------------|--------------|-------------------|------------|
| 77451694 | silver | 6,720 lm up 2,660 lm down | 4000 K | 120 lm/W | 1299.90 |

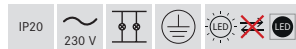

This item is subject to discount group 2.



Direct and indirect dimmable separately with button directly at the luminaire.



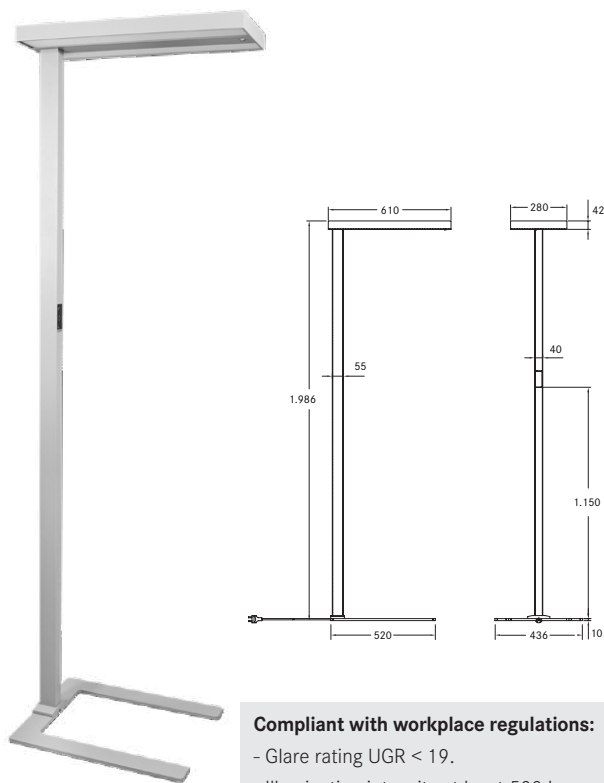

Compliant with workplace regulations:

- Glare rating UGR < 19.
- Illumination intensity at least 500 Lux.
- Flicker-free light.

MIKOL LED free-standing luminaire, micro-prismatic cover with indirect light component NEW

Lamp: LED not replaceable, power: 100 W, colour rendering: CRI > 80, glare rating: UGR < 17, control: touch dimmer, motion sensor, daylight sensor, height: 1,986.2 mm, material: aluminium / steel / plastic, optics: microprisms (direct) / transparent (indirect)

Supply: incl. 1,500 mm supply cable with angled protective plug

| Article no. | Colour | Luminous flux | Colour temp. | System efficiency | Price in € |
|-------------|--------|------------------------------|--------------|-------------------|------------|
| 77453694 | silver | 8,000 lm up 4,000 lm down | 4000 K | 129 lm/W | 1659.00 |



This item is subject to discount group 2.



Direct and indirect dimmable separately with touch dimmer directly at the luminaire.

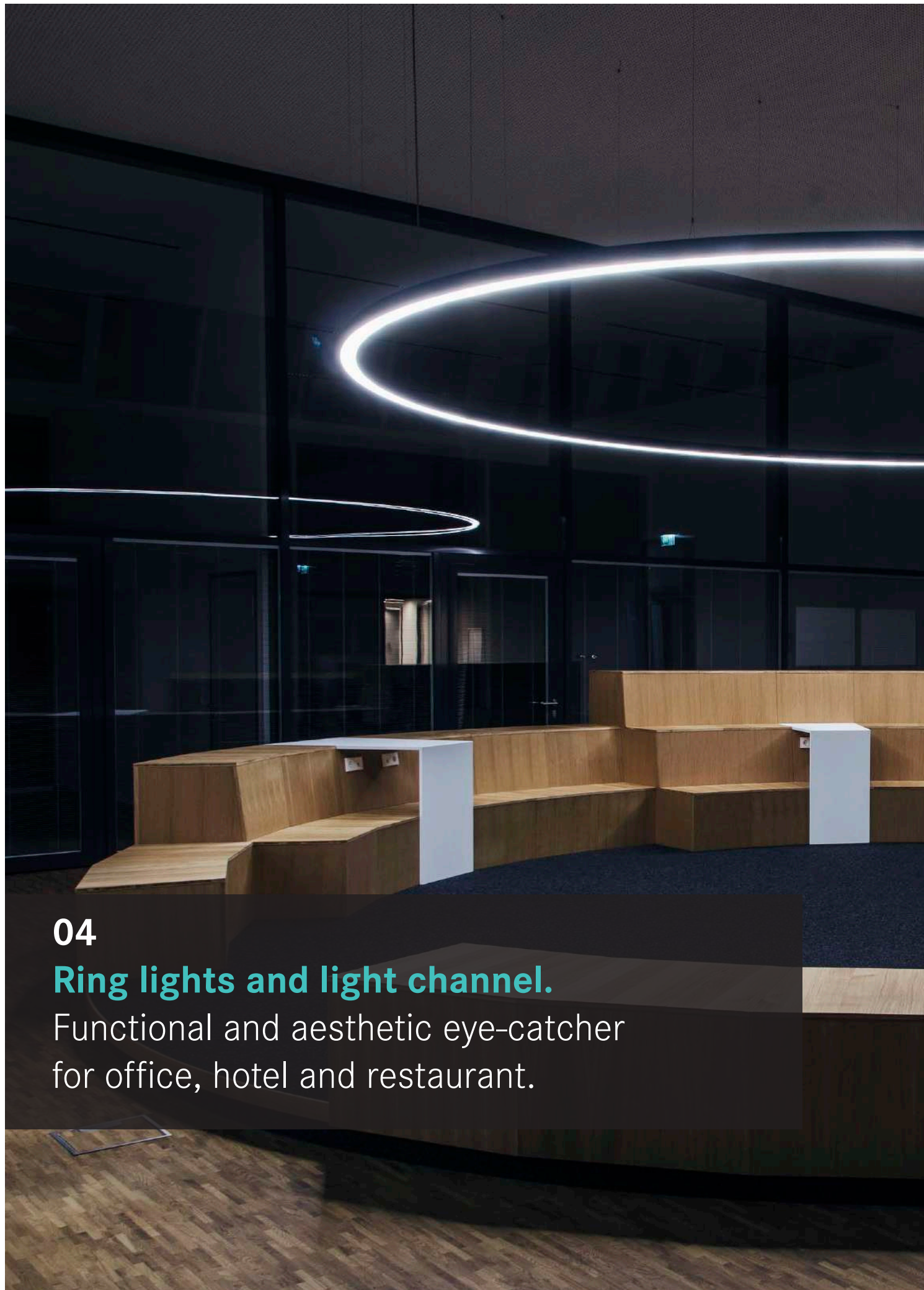

04

Ring lights and light channel.

Functional and aesthetic eye-catcher for office, hotel and restaurant.



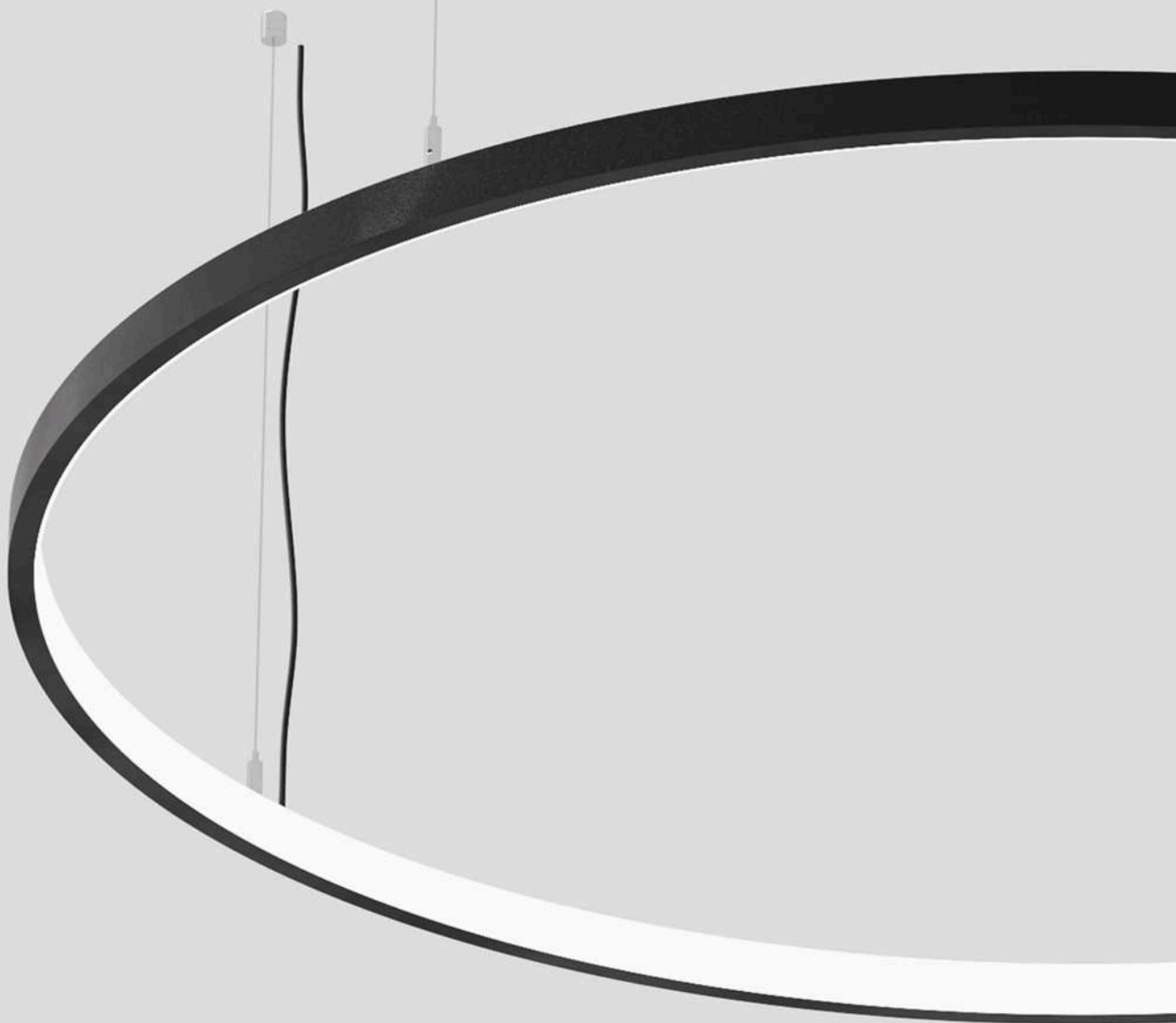

- Connection standard for Smarthome.
- Basis for standardised control of intelligent products.

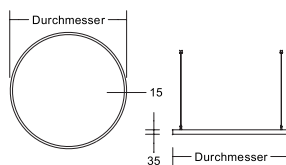

Height 35 mm

ANDROS IN LED pendant ring light

NEW

Lamp: LED, colour rendering: CRI > 90,
glare rating: UGR < 19, beam angle: 110°,
material: aluminium / steel / plastic

Supply:
incl. canopy

Service life:
L70/B50, 50,000 hrs. (ta: +25 °C)

| Diameter | Article no. textured white | Article no. textured black | Colour temp. | Cover | Control | Luminous flux | System efficiency | System power | Price in € |
|----------|-------------------------------|-------------------------------|-----------------|-------|---------------|------------------|----------------------|-----------------|------------|
| 800 mm | 84030173 | 84030183 | 3,000 K | opal | DALI-2 | 6,000 lm | 100 lm/W | 60 W | 999.90 |
| | 84030174 | 84030184 | 4,000 K | opal | DALI-2 | 6,000 lm | 100 lm/W | 60 W | 999.90 |
| | 84030173CA | 84030183CA | 3,000 K | opal | Casambi | 6,000 lm | 100 lm/W | 60 W | 1299.90 |
| | 84030174CA | 84030184CA | 4,000 K | opal | Casambi | 6,000 lm | 100 lm/W | 60 W | 1299.90 |
| | 84030173MT | 84030183MT | 3,000 K | opal | Matter | 6,000 lm | 100 lm/W | 60 W | 1299.90 |
| | 84030174MT | 84030184MT | 4,000 K | opal | Matter | 6,000 lm | 100 lm/W | 60 W | 1299.90 |
| 1,200 mm | 84032173 | 13925183 | 3,000 K | opal | DALI-2 | 9,000 lm | 100 lm/W | 90 W | 1399.90 |
| | 84032174 | 13925183 | 4,000 K | opal | DALI-2 | 9,000 lm | 100 lm/W | 90 W | 1399.90 |
| | 84032173CA | 13925184 | 3,000 K | opal | Casambi | 9,000 lm | 100 lm/W | 90 W | 1699.90 |
| | 84032174CA | 13925184 | 4,000 K | opal | Casambi | 9,000 lm | 100 lm/W | 90 W | 1699.90 |
| | 84032173MT | 13935183 | 3,000 K | opal | Matter | 9,000 lm | 100 lm/W | 90 W | 1699.90 |
| | 84032174MT | 13935184 | 4,000 K | opal | Matter | 9,000 lm | 100 lm/W | 90 W | 1699.90 |
| 1,800 mm | 84034173 | 13925183 | 3,000 K | opal | DALI-2 | 13,000 lm | 100 lm/W | 130 W | 2099.90 |
| | 84034174 | 13925183 | 4,000 K | opal | DALI-2 | 13,000 lm | 100 lm/W | 130 W | 2099.90 |
| | 84034173CA | 13925184 | 3,000 K | opal | Casambi | 13,000 lm | 100 lm/W | 130 W | 2399.90 |
| | 84034174CA | 13925184 | 4,000 K | opal | Casambi | 13,000 lm | 100 lm/W | 130 W | 2399.90 |
| | 84034173MT | 13935183 | 3,000 K | opal | Matter | 13,000 lm | 100 lm/W | 130 W | 2399.90 |
| | 84034174MT | 13935184 | 4,000 K | opal | Matter | 13,000 lm | 100 lm/W | 130 W | 2399.90 |



These items are subject to discount group 2.



- Connection standard for Smarthome.
- Basis for standardised control of intelligent products.

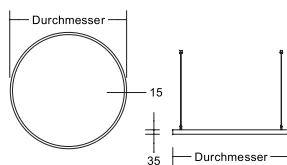

Height 35 mm

ANDROS OUT LED pendant ring light

NEW

Lamp: LED, colour rendering: CRI > 90,
glare rating: UGR < 19, beam angle: 110°,
material: aluminium / steel / plastic

Supply:

incl. canopy

Service life:

L70/B50, 50,000 hrs. (ta: +25 °C)

| Diameter | Article no. textured white | Article no. textured black | Colour temp. | Cover | Control | Luminous flux | System efficiency | System power | Price in € |
|----------|-------------------------------|-------------------------------|-----------------|-------|---------------|------------------|----------------------|-----------------|------------|
| 800 mm | 84070173 | 84070183 | 3,000 K | opal | DALI-2 | 6,000 lm | 100 lm/W | 60 W | 999.90 |
| | 84070174 | 84070184 | 4,000 K | opal | DALI-2 | 6,000 lm | 100 lm/W | 60 W | 999.90 |
| | 84070173CA | 84070183CA | 3,000 K | opal | Casambi | 6,000 lm | 100 lm/W | 60 W | 1299.90 |
| | 84070174CA | 84070184CA | 4,000 K | opal | Casambi | 6,000 lm | 100 lm/W | 60 W | 1299.90 |
| | 84070173MT | 84070183MT | 3,000 K | opal | Matter | 6,000 lm | 100 lm/W | 60 W | 1299.90 |
| | 84070174MT | 84070184MT | 4,000 K | opal | Matter | 6,000 lm | 100 lm/W | 60 W | 1299.90 |
| 1,200 mm | 84072173 | 84072183 | 3,000 K | opal | DALI-2 | 9,000 lm | 100 lm/W | 90 W | 1399.90 |
| | 84072174 | 84072184 | 4,000 K | opal | DALI-2 | 9,000 lm | 100 lm/W | 90 W | 1399.90 |
| | 84072173CA | 84072183CA | 3,000 K | opal | Casambi | 9,000 lm | 100 lm/W | 90 W | 1699.90 |
| | 84072174CA | 84072184CA | 4,000 K | opal | Casambi | 9,000 lm | 100 lm/W | 90 W | 1699.90 |
| | 84072173MT | 84072183MT | 3,000 K | opal | Matter | 9,000 lm | 100 lm/W | 90 W | 1699.90 |
| | 84072174MT | 84072184MT | 4,000 K | opal | Matter | 9,000 lm | 100 lm/W | 90 W | 1699.90 |
| 1,800 mm | 84074173 | 84074183 | 3,000 K | opal | DALI-2 | 13,000 lm | 100 lm/W | 130 W | 2099.90 |
| | 84074174 | 84074184 | 4,000 K | opal | DALI-2 | 13,000 lm | 100 lm/W | 130 W | 2099.90 |
| | 84074173CA | 84074183CA | 3,000 K | opal | Casambi | 13,000 lm | 100 lm/W | 130 W | 2399.90 |
| | 84074174CA | 84074184CA | 4,000 K | opal | Casambi | 13,000 lm | 100 lm/W | 130 W | 2399.90 |
| | 84074173MT | 84074183MT | 3,000 K | opal | Matter | 13,000 lm | 100 lm/W | 130 W | 2399.90 |
| | 84074174MT | 84074184MT | 4,000 K | opal | Matter | 13,000 lm | 100 lm/W | 130 W | 2399.90 |



These items are subject to discount group 2.

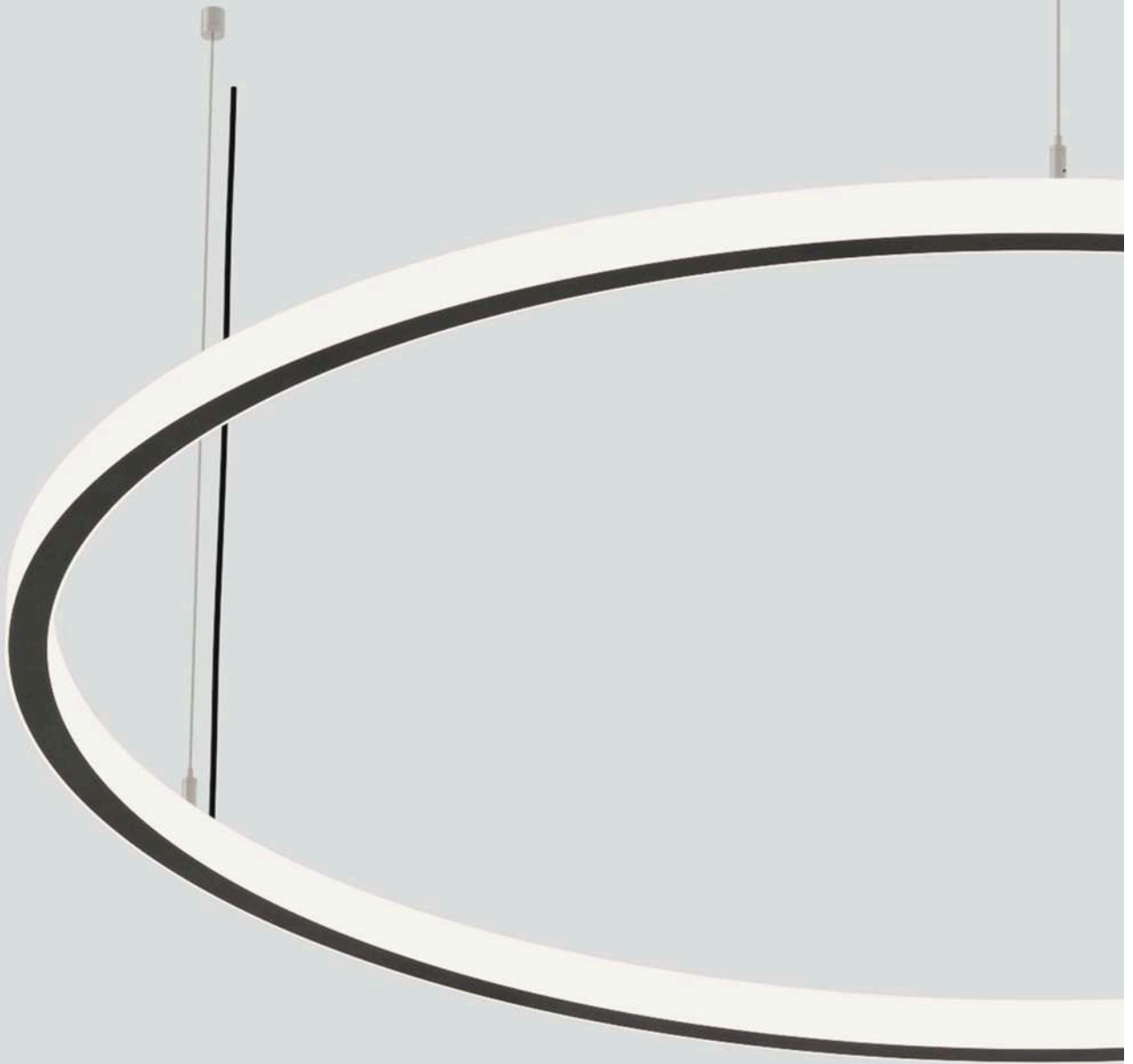

- Connection standard for Smarthome.
- Basis for standardised control of intelligent products.

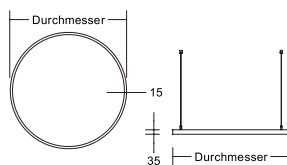
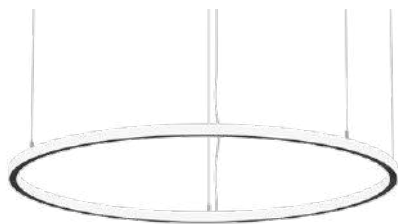

Height 35 mm

ANDROS IN/OUT LED pendant ring light

NEW

Lamp: LED, colour rendering: CRI > 90,
glare rating: UGR < 19, beam angle: 110°,
material: aluminium / steel / plastic

Supply:

incl. canopy

Service life:

L70/B50, 50,000 hrs. (ta: +25 °C)

| Diameter | Article no. textured white | Article no. textured black | Colour temp. | Cover | Control | Luminous flux | System efficiency | System power | Price in € |
|----------|-------------------------------|-------------------------------|-----------------|-------|---------------|------------------|----------------------|-----------------|------------|
| 800 mm | 84110173 | 84110183 | 3,000 K | opal | DALI-2 | 6,000 lm | 100 lm/W | 60 W | 2099.90 |
| | 84110174 | 84110184 | 4,000 K | opal | DALI-2 | 6,000 lm | 100 lm/W | 60 W | 2099.90 |
| | 84110173CA | 84110183CA | 3,000 K | opal | Casambi | 6,000 lm | 100 lm/W | 60 W | 2399.90 |
| | 84110174CA | 84110184CA | 4,000 K | opal | Casambi | 6,000 lm | 100 lm/W | 60 W | 2399.90 |
| | 84110173MT | 84110183MT | 3,000 K | opal | Matter | 6,000 lm | 100 lm/W | 60 W | 2399.90 |
| | 84110174MT | 84110184MT | 4,000 K | opal | Matter | 6,000 lm | 100 lm/W | 60 W | 2399.90 |
| 1,200 mm | 84112173 | 84112183 | 3,000 K | opal | DALI-2 | 9,000 lm | 100 lm/W | 90 W | 2699.90 |
| | 84112174 | 84112184 | 4,000 K | opal | DALI-2 | 9,000 lm | 100 lm/W | 90 W | 2699.90 |
| | 84112173CA | 84112183CA | 3,000 K | opal | Casambi | 9,000 lm | 100 lm/W | 90 W | 2999.90 |
| | 84112174CA | 84112184CA | 4,000 K | opal | Casambi | 9,000 lm | 100 lm/W | 90 W | 2999.90 |
| | 84112173MT | 84112183MT | 3,000 K | opal | Matter | 9,000 lm | 100 lm/W | 90 W | 2999.90 |
| | 84112174MT | 84112184MT | 4,000 K | opal | Matter | 9,000 lm | 100 lm/W | 90 W | 2999.90 |
| 1,800 mm | 84114173 | 84114183 | 3,000 K | opal | DALI-2 | 13,000 lm | 100 lm/W | 130 W | 3699.90 |
| | 84114174 | 84114184 | 4,000 K | opal | DALI-2 | 13,000 lm | 100 lm/W | 130 W | 3699.90 |
| | 84114173CA | 84114183CA | 3,000 K | opal | Casambi | 13,000 lm | 100 lm/W | 130 W | 3999.90 |
| | 84114174CA | 84114184CA | 4,000 K | opal | Casambi | 13,000 lm | 100 lm/W | 130 W | 3999.90 |
| | 84114173MT | 84114183MT | 3,000 K | opal | Matter | 13,000 lm | 100 lm/W | 130 W | 3999.90 |
| | 84114174MT | 84114184MT | 4,000 K | opal | Matter | 13,000 lm | 100 lm/W | 130 W | 3999.90 |



These items are subject to discount group 2.







- Connection standard for Smarthome.
- Basis for standardised control of intelligent products.

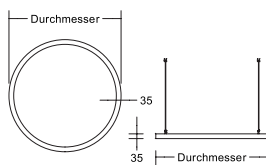
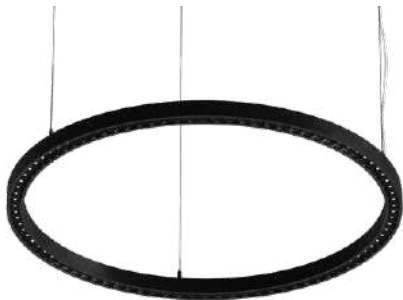

Height 35 mm

DEVON LED pendant ring light

NEW

Lamp: LED, colour rendering: CRI > 90, UGR < 19,
beam angle: 36°, material: aluminium / steel / plastic

Supply:

incl. canopy

Service life:

L70/B50, 50,000 hrs. (ta: +25 °C)

| Diameter | Article no. textured white | Article no. textured black | Colour temp. | Cover | Control | Luminous flux | System efficiency | System power | Price in € |
|----------|-------------------------------|-------------------------------|-----------------|-------|---------------|------------------|----------------------|-----------------|------------|
| 800 mm | 84010173 | 84010183 | 3,000 K | opal | DALI-2 | 4,000 lm | 100 lm/W | 40 W | 1949.90 |
| | 84010174 | 84010184 | 4,000 K | opal | DALI-2 | 4,000 lm | 100 lm/W | 40 W | 1949.90 |
| | 84010173CA | 84010183CA | 3,000 K | opal | Casambi | 4,000 lm | 100 lm/W | 40 W | 2099.90 |
| | 84010174CA | 84010184CA | 4,000 K | opal | Casambi | 4,000 lm | 100 lm/W | 40 W | 2099.90 |
| | 84010173MT | 84010183MT | 3,000 K | opal | Matter | 4,000 lm | 100 lm/W | 40 W | 2099.90 |
| | 84010174MT | 84010184MT | 4,000 K | opal | Matter | 4,000 lm | 100 lm/W | 40 W | 2099.90 |
| 1,200 mm | 84012173 | 84012183 | 3,000 K | opal | DALI-2 | 5,400 lm | 100 lm/W | 54 W | 2499.90 |
| | 84012174 | 84012184 | 4,000 K | opal | DALI-2 | 5,400 lm | 100 lm/W | 54 W | 2499.90 |
| | 84012173CA | 84012183CA | 3,000 K | opal | Casambi | 5,400 lm | 100 lm/W | 54 W | 2699.90 |
| | 84012174CA | 84012184CA | 4,000 K | opal | Casambi | 5,400 lm | 100 lm/W | 54 W | 2699.90 |
| | 84012173MT | 84012183MT | 3,000 K | opal | Matter | 5,400 lm | 100 lm/W | 54 W | 2699.90 |
| | 84012174MT | 84012184MT | 4,000 K | opal | Matter | 5,400 lm | 100 lm/W | 54 W | 2699.90 |
| 1,800 mm | 84014173 | 84014183 | 3,000 K | opal | DALI-2 | 8,100 lm | 100 lm/W | 81 W | 3849.90 |
| | 84014174 | 84014184 | 4,000 K | opal | DALI-2 | 8,100 lm | 100 lm/W | 81 W | 3849.90 |
| | 84014173CA | 84014183CA | 3,000 K | opal | Casambi | 8,100 lm | 100 lm/W | 81 W | 3999.90 |
| | 84014174CA | 84014184CA | 4,000 K | opal | Casambi | 8,100 lm | 100 lm/W | 81 W | 3999.90 |
| | 84014173MT | 84014183MT | 3,000 K | opal | Matter | 8,100 lm | 100 lm/W | 81 W | 3999.90 |
| | 84014174MT | 84014184MT | 4,000 K | opal | Matter | 8,100 lm | 100 lm/W | 81 W | 3999.90 |



These items are subject to discount group 2.





Made from
50% recycled
PET
bottles







Acoustic panel

Suitable for DEVON ring lights Ø 800 mm and Ø 1,200 mm.

- Needle felt
- High acoustic performance
- Lightweight: 1,300 g / m²
- 50% recycled PET from PET bottle waste
- Fire protection and self-extinguishing
- Light fastness: 6+
- Formaldehyde-free
- Moisture absorption: >0.03% by weight (50 °C/122 °F at 90% relative humidity)
- Excellent thermal insulation: 0.040 W/mK
- 99.9% antibacterial structure (ISO-20743)
- Designed for easy mounting and installation
- Easy to clean with a damp cloth or Hoover



Colour fan:
Article no.: 82000000
Price: 49.90 €

| Diameter |  |  |  |  |  |  |  |
|-------------------|---|---|---|---|---|---|---|
| Ø 800 mm | 82010000DG | 82010000HG | 82010000BL | 82010000GR | 82010000GE | 82010000OR | 82010000RO |
| Price: 849.90 € | | | | | | | |
| Ø 1,200 mm | 82012000DG | 82012000HG | 82012000BL | 82012000GR | 82012000GE | 82012000OR | 82012000RO |
| Price: 1,449.90 € | | | | | | | |

BIRO ring lights.

Lighting mood with BIRO CIRCLE.

In addition to numerous corner connections that enable various geometries, the BIRO lighting channel system can also be used to create ring-shaped luminaires in various sizes of up to six metres. We supply the lights in black, white and silver up to 2,500 mm as standard.

On request, we also offer individually designed ring lights in various colours and special sizes up to 6,000 mm in diameter. We also offer enclosed round and square luminaires with full-surface light emission.

Aviation and floating ring lights.

At Frankfurt Airport (FraPort), Brumberg has provided a special lighting solution with customised BIRO CIRCLE pendant ring luminaires. The properties of the lights are ideal for this task: direct and indirect lighting, rotationally symmetrical, deep-wide beam light distribution and light distribution through a microprismatic plastic cover.

More information
about FraPort Frankfurt

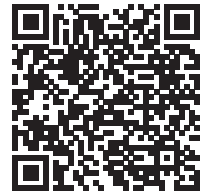

Decentralised canopy



Central canopy



RAL surfaces

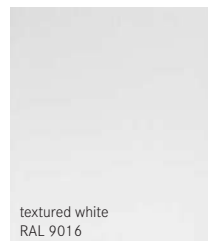

textured white
RAL 9016

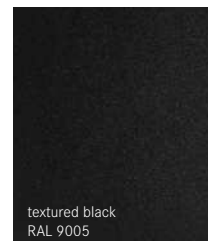

textured black
RAL 9005



textured silver
RAL 9006

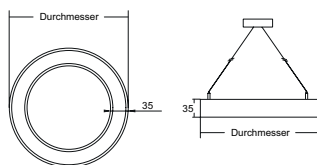
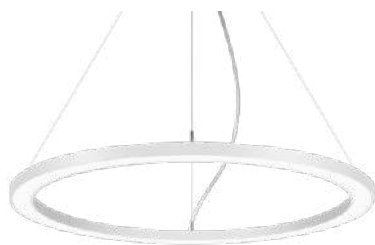

Height 35 mm

BIRO CIRCLE pendant ring light, direct

NEW

Lamp: LED, input voltage: 220 – 240 V AC, 50 – 60 Hz,
colour rendering: CRI > 80, cover: PC, opal,
material: aluminium / steel / plastic, pendant length: 5,000 mm

Supply:

incl. central canopy

Service life:

L90/B10, 74,000 hrs. (ta: +25 °C)

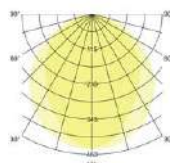

| Diameter | Article no. textured silver | Article no. textured white | Article no. textured black | Colour temp. | Cover | Control | Luminous flux | System efficiency | System power | Price in € |
|----------|--------------------------------|-------------------------------|-------------------------------|-----------------|-------|-------------|------------------|----------------------|-----------------|------------|
| 450 mm | 13925163 | 13925173 | 13925183 | 3,000 K | opal | switchable | 3,344 lm | 101 lm/W | 30 W | 599.90 |
| | 13925164 | 13925174 | 13925184 | 4,000 K | opal | switchable | 3,525 lm | 106 lm/W | 30 W | 599.90 |
| | 13935163 | 13935173 | 13935183 | 3,000 K | opal | DALI | 3,344 lm | 101 lm/W | 30 W | 799.90 |
| | 13935164 | 13935174 | 13935184 | 4,000 K | opal | DALI | 3,525 lm | 106 lm/W | 30 W | 799.90 |
| 600 mm | 13920163 | 13920173 | 13920183 | 3,000 K | opal | switchable | 4,459 lm | 101 lm/W | 40 W | 789.90 |
| | 13920164 | 13920174 | 13920184 | 4,000 K | opal | switchable | 4,700 lm | 106 lm/W | 40 W | 789.90 |
| | 13930163 | 13930173 | 13930183 | 3,000 K | opal | DALI | 4,459 lm | 101 lm/W | 40 W | 899.90 |
| | 13930164 | 13930174 | 13930184 | 4,000 K | opal | DALI | 4,700 lm | 106 lm/W | 40 W | 899.90 |
| 750 mm | 13921163 | 13921173 | 13921183 | 3,000 K | opal | switchable | 5,573 lm | 101 lm/W | 50 W | 1009.90 |
| | 13921164 | 13921174 | 13921184 | 4,000 K | opal | switchable | 5,884 lm | 106 lm/W | 50 W | 1009.90 |
| | 13931163 | 13931173 | 13931183 | 3,000 K | opal | DALI | 5,573 lm | 101 lm/W | 50 W | 1199.90 |
| | 13931164 | 13931174 | 13931184 | 4,000 K | opal | DALI | 5,884 lm | 106 lm/W | 50 W | 1199.90 |
| 1,000 mm | 13922163 | 13922173 | 13922183 | 3,000 K | opal | switchable | 7,431 lm | 103 lm/W | 65 W | 1399.90 |
| | 13922164 | 13922174 | 13922184 | 4,000 K | opal | switchable | 7,835 lm | 109 lm/W | 65 W | 1399.90 |
| | 13932163 | 13932173 | 13932183 | 3,000 K | opal | DALI | 7,431 lm | 103 lm/W | 65 W | 1499.90 |
| | 13932164 | 13932174 | 13932184 | 4,000 K | opal | DALI | 7,835 lm | 109 lm/W | 65 W | 1499.90 |
| 1,200 mm | 13923163 | 13923173 | 13923183 | 3,000 K | opal | switchable | 8,918 lm | 103 lm/W | 78 W | 1699.90 |
| | 13923164 | 13923174 | 13923184 | 4,000 K | opal | switchable | 9,401 lm | 109 lm/W | 78 W | 1699.90 |
| | 13933163 | 13933173 | 13933183 | 3,000 K | opal | DALI | 8,918 lm | 103 lm/W | 78 W | 1799.90 |
| | 13933164 | 13933174 | 13933184 | 4,000 K | opal | DALI | 9,401 lm | 109 lm/W | 78 W | 1799.90 |



Also available in: TunableWhite & Casambi

These items are subject to discount group 2.

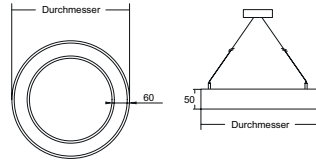

Height 50 mm

BIRO CIRCLE pendant ring light, direct

NEW

Lamp: LED, input voltage: 220 - 240 V AC, 50 - 60 Hz, colour rendering: CRI > 80, cover: PC, opal, material: aluminium / steel / plastic, pendant length: 5,000 mm

Supply:
incl. central canopy

Service life:
L90/B10, 74,000 hrs. (ta: +25 °C)

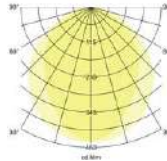

| Diameter | Article no. textured silver | Article no. textured white | Article no. textured black | Colour temp. | Cover | Control | Luminous flux | System efficiency | System power | Price in € |
|----------|-----------------------------|----------------------------|----------------------------|--------------|-------|-------------|---------------|-------------------|--------------|------------|
| 450 mm | 13825163 | 13825173 | 13825183 | 3,000 K | opal | switchable | 3,017 lm | 101 lm/W | 30 W | 569.90 |
| | 13825164 | 13825174 | 13825184 | 4,000 K | opal | switchable | 3,181 lm | 106 lm/W | 30 W | 569.90 |
| | 13835163 | 13835173 | 13835183 | 3,000 K | opal | DALI | 3,017 lm | 101 lm/W | 30 W | 669.90 |
| | 13835164 | 13835174 | 13835184 | 4,000 K | opal | DALI | 3,181 lm | 106 lm/W | 30 W | 669.90 |
| 600 mm | 13820163 | 13820173 | 13820183 | 3,000 K | opal | switchable | 4,023 lm | 101 lm/W | 40 W | 739.90 |
| | 13820164 | 13820174 | 13820184 | 4,000 K | opal | switchable | 4,241 lm | 106 lm/W | 40 W | 739.90 |
| | 13830163 | 13830173 | 13830183 | 3,000 K | opal | DALI | 4,023 lm | 101 lm/W | 40 W | 899.90 |
| | 13830164 | 13830174 | 13830184 | 4,000 K | opal | DALI | 4,241 lm | 106 lm/W | 40 W | 899.90 |
| 750 mm | 13821163 | 13821173 | 13821183 | 3,000 K | opal | switchable | 5,028 lm | 103 lm/W | 50 W | 949.90 |
| | 13821164 | 13821174 | 13821184 | 4,000 K | opal | switchable | 5,309 lm | 109 lm/W | 50 W | 949.90 |
| | 13831163 | 13831173 | 13831183 | 3,000 K | opal | DALI | 5,028 lm | 103 lm/W | 50 W | 1099.90 |
| | 13831164 | 13831174 | 13831184 | 4,000 K | opal | DALI | 5,309 lm | 109 lm/W | 50 W | 1099.90 |
| 1,000 mm | 13822163 | 13822173 | 13822183 | 3,000 K | opal | switchable | 6,705 lm | 103 lm/W | 65 W | 1299.90 |
| | 13822164 | 13822174 | 13822184 | 4,000 K | opal | switchable | 7,069 lm | 109 lm/W | 65 W | 1299.90 |
| | 13832163 | 13832173 | 13832183 | 3,000 K | opal | DALI | 6,705 lm | 103 lm/W | 65 W | 1399.90 |
| | 13832164 | 13832174 | 13832184 | 4,000 K | opal | DALI | 7,069 lm | 109 lm/W | 65 W | 1399.90 |
| 1,200 mm | 13823163 | 13823173 | 13823183 | 3,000 K | opal | switchable | 8,046 lm | 103 lm/W | 78 W | 1599.90 |
| | 13823164 | 13823174 | 13823184 | 4,000 K | opal | switchable | 8,482 lm | 109 lm/W | 78 W | 1599.90 |
| | 13833163 | 13833173 | 13833183 | 3,000 K | opal | DALI | 8,046 lm | 103 lm/W | 78 W | 1699.90 |
| | 13833164 | 13833174 | 13833184 | 4,000 K | opal | DALI | 8,482 lm | 109 lm/W | 78 W | 1699.90 |
| 1,500 mm | 13824163 | 13824173 | 13824183 | 3,000 K | opal | switchable | 10,058 lm | 103 lm/W | 98 W | 1999.90 |
| | 13824164 | 13824174 | 13824184 | 4,000 K | opal | switchable | 10,603 lm | 108 lm/W | 98 W | 1999.90 |
| | 13834163 | 13834173 | 13834183 | 3,000 K | opal | DALI | 10,058 lm | 103 lm/W | 98 W | 2199.90 |
| | 13834164 | 13834174 | 13834184 | 4,000 K | opal | DALI | 10,603 lm | 108 lm/W | 98 W | 2199.90 |
| 1,800 mm | 13827163 | 13827173 | 13827183 | 3,000 K | opal | switchable | 12,293 lm | 102 lm/W | 120 W | 2799.90 |
| | 13827164 | 13827174 | 13827184 | 4,000 K | opal | switchable | 12,960 lm | 108 lm/W | 120 W | 2799.90 |
| | 13837163 | 13837173 | 13837183 | 3,000 K | opal | DALI | 12,293 lm | 102 lm/W | 120 W | 2999.90 |
| | 13837164 | 13837174 | 13837184 | 4,000 K | opal | DALI | 12,960 lm | 108 lm/W | 120 W | 2999.90 |
| 2,000 mm | 13826163 | 13826173 | 13826183 | 3,000 K | opal | switchable | 13,536 lm | 101 lm/W | 134 W | 2999.90 |
| | 13826164 | 13826174 | 13826184 | 4,000 K | opal | switchable | 14,270 lm | 106 lm/W | 134 W | 2999.90 |
| | 13836163 | 13836173 | 13836183 | 3,000 K | opal | DALI | 13,536 lm | 101 lm/W | 134 W | 3399.90 |
| | 13836164 | 13836174 | 13836184 | 4,000 K | opal | DALI | 14,270 lm | 106 lm/W | 134 W | 3399.90 |



Also available in: TunableWhite & Casambi

These items are subject to discount group 2.

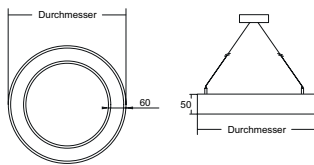

Height 50 mm

**BIRO CIRCLE pendant ring light,
direct / indirect**

NEW

Lamp: LED, input voltage: 220 – 240 V AC, 50 – 60 Hz,
colour rendering: CRI > 80, cover: PC, opal, luminous flux component
(direct/indirect in %): 70/30, material: aluminium / steel / plastic, pen-
dant length: 5,000 mm

Supply:
incl. central canopy

Service life:
L90/B10, 74,000 hrs. (ta: +25 °C)

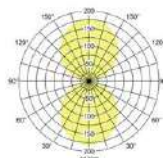

LED LIGHTING
FUNDING

BEG

Eligible for BEG

| Diameter | Article no. textured silver | Article no. textured white | Article no. textured black | Colour temp. | Cover | Control | Luminous flux | System efficiency | System power | Price in € |
|----------|--------------------------------|-------------------------------|-------------------------------|-----------------|-------|-------------|------------------|----------------------|-----------------|------------|
| 450 mm | 13845163 | 13845173 | 13845183 | 3,000 K | opal | switchable | 5,193 lm | 115 lm/W | 45 W | 789.90 |
| | 13845164 | 13845174 | 13845184 | 4,000 K | opal | switchable | 5,475 lm | 122 lm/W | 45 W | 789.90 ■ |
| | 13855163 | 13855173 | 13855183 | 3,000 K | opal | DALI | 5,193 lm | 115 lm/W | 45 W | 899.90 |
| | 13855164 | 13855174 | 13855184 | 4,000 K | opal | DALI | 5,475 lm | 122 lm/W | 45 W | 899.90 ■ |
| 600 mm | 13840163 | 13840173 | 13840183 | 3,000 K | opal | switchable | 6,924 lm | 115 lm/W | 60 W | 1009.90 |
| | 13840164 | 13840174 | 13840184 | 4,000 K | opal | switchable | 7,300 lm | 122 lm/W | 60 W | 1009.90 ■ |
| | 13850163 | 13850173 | 13850183 | 3,000 K | opal | DALI | 6,924 lm | 115 lm/W | 60 W | 1119.90 |
| | 13850164 | 13850174 | 13850184 | 4,000 K | opal | DALI | 7,300 lm | 122 lm/W | 60 W | 1119.90 ■ |
| 750 mm | 13841163 | 13841173 | 13841183 | 3,000 K | opal | switchable | 8,656 lm | 115 lm/W | 75 W | 1229.90 |
| | 13841164 | 13841174 | 13841184 | 4,000 K | opal | switchable | 9,134 lm | 122 lm/W | 75 W | 1229.90 ■ |
| | 13851163 | 13851173 | 13851183 | 3,000 K | opal | DALI | 8,656 lm | 115 lm/W | 75 W | 1339.90 |
| | 13851164 | 13851174 | 13851184 | 4,000 K | opal | DALI | 9,134 lm | 122 lm/W | 75 W | 1339.90 ■ |
| 1,000 mm | 13842163 | 13842173 | 13842183 | 3,000 K | opal | switchable | 11,541 lm | 118 lm/W | 98 W | 1699.90 |
| | 13842164 | 13842174 | 13842184 | 4,000 K | opal | switchable | 12,169 lm | 124 lm/W | 98 W | 1699.90 ■ |
| | 13852163 | 13852173 | 13852183 | 3,000 K | opal | DALI | 11,541 lm | 118 lm/W | 98 W | 1999.90 |
| | 13852164 | 13852174 | 13852184 | 4,000 K | opal | DALI | 12,169 lm | 124 lm/W | 98 W | 1999.90 ■ |
| 1,200 mm | 13843163 | 13843173 | 13843183 | 3,000 K | opal | switchable | 13,850 lm | 118 lm/W | 117 W | 1999.90 |
| | 13843164 | 13843174 | 13843184 | 4,000 K | opal | switchable | 14,602 lm | 125 lm/W | 117 W | 1999.90 ■ |
| | 13853163 | 13853173 | 13853183 | 3,000 K | opal | DALI | 13,850 lm | 118 lm/W | 117 W | 2299.90 |
| | 13853164 | 13853174 | 13853184 | 4,000 K | opal | DALI | 14,602 lm | 125 lm/W | 117 W | 2299.90 ■ |
| 1,500 mm | 13844163 | 13844173 | 13844183 | 3,000 K | opal | switchable | 17,314 lm | 118 lm/W | 147 W | 2699.90 |
| | 13844164 | 13844174 | 13844184 | 4,000 K | opal | switchable | 18,253 lm | 124 lm/W | 147 W | 2699.90 ■ |
| | 13854163 | 13854173 | 13854183 | 3,000 K | opal | DALI | 17,314 lm | 118 lm/W | 147 W | 2899.90 |
| | 13854164 | 13854174 | 13854184 | 4,000 K | opal | DALI | 18,253 lm | 124 lm/W | 147 W | 2899.90 ■ |
| 1,800 mm | 13847163 | 13847173 | 13847183 | 3,000 K | opal | switchable | 21,052 lm | 117 lm/W | 180 W | 3699.90 |
| | 13847164 | 13847174 | 13847184 | 4,000 K | opal | switchable | 22,228 lm | 123 lm/W | 180 W | 3699.90 ■ |
| | 13857163 | 13857173 | 13857183 | 3,000 K | opal | DALI | 21,052 lm | 117 lm/W | 180 W | 4499.90 |
| | 13857164 | 13857174 | 13857184 | 4,000 K | opal | DALI | 22,228 lm | 123 lm/W | 180 W | 4499.90 ■ |
| 2,000 mm | 13846163 | 13846173 | 13846183 | 3,000 K | opal | switchable | 23,225 lm | 116 lm/W | 201 W | 3999.90 |
| | 13846164 | 13846174 | 13846184 | 4,000 K | opal | switchable | 24,484 lm | 122 lm/W | 201 W | 3999.90 ■ |
| | 13856163 | 13856173 | 13856183 | 3,000 K | opal | DALI | 23,225 lm | 116 lm/W | 201 W | 4799.90 |
| | 13856164 | 13856174 | 13856184 | 4,000 K | opal | DALI | 24,484 lm | 122 lm/W | 201 W | 4799.90 ■ |



Also available in: TunableWhite, RGB & Casambi

These items are subject to discount group 2.

Sizes in mm | All prices are recommended retail prices (RRP) in euros without VAT.
Errors excepted. | Orders are placed in accordance with our General Terms and Conditions of Sale printed on page 486 onwards.

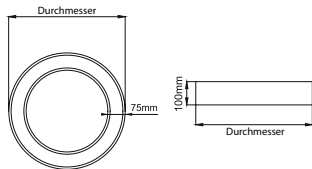

Lamp: LED, input voltage: 220 – 240 V AC,
50, 60 Hz, colour rendering: CRI > 80, cover: PC,
opal,
material: aluminium / steel / plastic

Service life:
L90/B10, 74,000 hrs. (ta: +25 °C)

Height 100 mm

BIRO CIRCLE surface-mounted ring light, direct

NEW

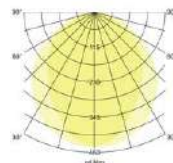

| Diameter | Article no. textured silver | Article no. textured white | Article no. textured black | Colour temp. | Cover | Control | Luminous flux | System efficiency | System power | Price in € |
|----------|-----------------------------|----------------------------|----------------------------|--------------|-------|-------------|---------------|-------------------|--------------|------------|
| 450 mm | 13565163 | 13565173 | 13565183 | 3,000 K | opal | switchable | 3,017 lm | 100 lm/W | 30 W | 569.90 |
| | 13565164 | 13565174 | 13565184 | 4,000 K | opal | switchable | 3,181 lm | 106 lm/W | 30 W | 569.90 |
| | 13575163 | 13575173 | 13575183 | 3,000 K | opal | DALI | 3,017 lm | 100 lm/W | 30 W | 669.90 |
| | 13575164 | 13575174 | 13575184 | 4,000 K | opal | DALI | 3,181 lm | 106 lm/W | 30 W | 669.90 |
| 600 mm | 13560163 | 13560173 | 13560183 | 3,000 K | opal | switchable | 4,023 lm | 100 lm/W | 40 W | 789.90 |
| | 13560164 | 13560174 | 13560184 | 4,000 K | opal | switchable | 4,241 lm | 106 lm/W | 40 W | 789.90 |
| | 13570163 | 13570173 | 13570183 | 3,000 K | opal | DALI | 4,023 lm | 100 lm/W | 40 W | 899.90 |
| | 13570164 | 13570174 | 13570184 | 4,000 K | opal | DALI | 4,241 lm | 106 lm/W | 40 W | 899.90 |
| 750 mm | 13561163 | 13561173 | 13561183 | 3,000 K | opal | switchable | 5,028 lm | 100 lm/W | 50 W | 1009.90 |
| | 13561164 | 13561174 | 13561184 | 4,000 K | opal | switchable | 5,309 lm | 106 lm/W | 50 W | 1009.90 |
| | 13571163 | 13571173 | 13571183 | 3,000 K | opal | DALI | 5,028 lm | 100 lm/W | 50 W | 1119.90 |
| | 13571164 | 13571174 | 13571184 | 4,000 K | opal | DALI | 5,309 lm | 106 lm/W | 50 W | 1119.90 |
| 1,000 mm | 13562163 | 13562173 | 13562183 | 3,000 K | opal | switchable | 6,705 lm | 103 lm/W | 65 W | 1299.90 |
| | 13562164 | 13562174 | 13562184 | 4,000 K | opal | switchable | 7,069 lm | 108 lm/W | 65 W | 1299.90 |
| | 13572163 | 13572173 | 13572183 | 3,000 K | opal | DALI | 6,705 lm | 103 lm/W | 65 W | 1399.90 |
| | 13572164 | 13572174 | 13572184 | 4,000 K | opal | DALI | 7,069 lm | 108 lm/W | 65 W | 1399.90 |
| 1,200 mm | 13563163 | 13563173 | 13563183 | 3,000 K | opal | switchable | 8,046 lm | 103 lm/W | 78 W | 1599.90 |
| | 13563164 | 13563174 | 13563184 | 4,000 K | opal | switchable | 8,482 lm | 109 lm/W | 78 W | 1599.90 |
| | 13573163 | 13573173 | 13573183 | 3,000 K | opal | DALI | 8,046 lm | 103 lm/W | 78 W | 1799.90 |
| | 13573164 | 13573174 | 13573184 | 4,000 K | opal | DALI | 8,482 lm | 109 lm/W | 78 W | 1799.90 |
| 1,500 mm | 13564163 | 13564173 | 13564183 | 3,000 K | opal | switchable | 10,058 lm | 102 lm/W | 98 W | 1999.90 |
| | 13564164 | 13564174 | 13564184 | 4,000 K | opal | switchable | 10,603 lm | 108 lm/W | 98 W | 1999.90 |
| | 13574163 | 13574173 | 13574183 | 3,000 K | opal | DALI | 10,058 lm | 102 lm/W | 98 W | 2199.90 |
| | 13574164 | 13574174 | 13574184 | 4,000 K | opal | DALI | 10,603 lm | 108 lm/W | 98 W | 2199.90 |



These items are subject to discount group 2.

Also available in:
Ø 600 mm: in Casambi
Ø 750 mm – 1,500 mm: in TunableWhite & Casambi

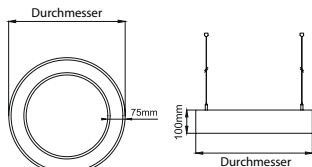

Lamp: LED, input voltage: 220 – 240 V AC, 50 – 60 Hz, colour rendering: CRI > 80, cover: PC, opal, material: aluminium / steel / plastic, pendant length: 5,000 mm

Supply:
 Ø 450 mm incl. central canopy,
 Ø 600 mm to Ø 2,500 mm incl. decentralised canopy
 (central canopy on request)

Service life:
 L90/B10, 74,000 hrs. (ta: +25 °C)

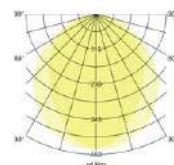

Height 100 mm

BIRO CIRCLE pendant ring light, direct

NEW

| Diameter | Article no. textured silver | Article no. textured white | Article no. textured black | Colour temp. | Cover | Control | Luminous flux | System efficiency | System power | Price in € |
|----------|-----------------------------|----------------------------|----------------------------|--------------|-------|-------------|---------------|-------------------|--------------|------------|
| 450 mm | 13525163 | 13525173 | 13525183 | 3,000 K | opal | switchable | 3,017 lm | 100 lm/W | 30 W | 559.90 |
| | 13525164 | 13525174 | 13525184 | 4,000 K | opal | switchable | 3,181 lm | 106 lm/W | 30 W | 559.90 |
| | 13535163 | 13535173 | 13535183 | 3,000 K | opal | DALI | 3,017 lm | 100 lm/W | 30 W | 669.90 |
| | 13535164 | 13535174 | 13535184 | 4,000 K | opal | DALI | 3,181 lm | 106 lm/W | 30 W | 669.90 |
| 600 mm | 13520163 | 13520173 | 13520183 | 3,000 K | opal | switchable | 4,023 lm | 100 lm/W | 40 W | 739.90 |
| | 13520164 | 13520174 | 13520184 | 4,000 K | opal | switchable | 4,241 lm | 106 lm/W | 40 W | 739.90 |
| | 13530163 | 13530173 | 13530183 | 3,000 K | opal | DALI | 4,023 lm | 100 lm/W | 40 W | 899.90 |
| | 13530164 | 13530174 | 13530184 | 4,000 K | opal | DALI | 4,241 lm | 106 lm/W | 40 W | 899.90 |
| 750 mm | 13521163 | 13521173 | 13521183 | 3,000 K | opal | switchable | 5,028 lm | 100 lm/W | 50 W | 949.90 |
| | 13521164 | 13521174 | 13521184 | 4,000 K | opal | switchable | 5,309 lm | 106 lm/W | 50 W | 949.90 |
| | 13531163 | 13531173 | 13531183 | 3,000 K | opal | DALI | 5,028 lm | 100 lm/W | 50 W | 1119.90 |
| | 13531164 | 13531174 | 13531184 | 4,000 K | opal | DALI | 5,309 lm | 106 lm/W | 50 W | 1119.90 |
| 1,000 mm | 13522163 | 13522173 | 13522183 | 3,000 K | opal | switchable | 6,705 lm | 103 lm/W | 65 W | 1249.90 |
| | 13522164 | 13522174 | 13522184 | 4,000 K | opal | switchable | 7,069 lm | 108 lm/W | 65 W | 1249.90 |
| | 13532163 | 13532173 | 13532183 | 3,000 K | opal | DALI | 6,705 lm | 103 lm/W | 65 W | 1339.90 |
| | 13532164 | 13532174 | 13532184 | 4,000 K | opal | DALI | 7,069 lm | 108 lm/W | 65 W | 1339.90 |
| 1,200 mm | 13523163 | 13523173 | 13523183 | 3,000 K | opal | switchable | 8,046 lm | 103 lm/W | 78 W | 1499.90 |
| | 13523164 | 13523174 | 13523184 | 4,000 K | opal | switchable | 8,482 lm | 109 lm/W | 78 W | 1499.90 |
| | 13533163 | 13533173 | 13533183 | 3,000 K | opal | DALI | 8,046 lm | 103 lm/W | 78 W | 1599.90 |
| | 13533164 | 13533174 | 13533184 | 4,000 K | opal | DALI | 8,482 lm | 109 lm/W | 78 W | 1599.90 |
| 1,500 mm | 13524163 | 13524173 | 13524183 | 3,000 K | opal | switchable | 10,058 lm | 102 lm/W | 98 W | 1799.90 |
| | 13524164 | 13524174 | 13524184 | 4,000 K | opal | switchable | 10,603 lm | 108 lm/W | 98 W | 1799.90 |
| | 13534163 | 13534173 | 13534183 | 3,000 K | opal | DALI | 10,058 lm | 102 lm/W | 98 W | 1999.90 |
| | 13534164 | 13534174 | 13534184 | 4,000 K | opal | DALI | 10,603 lm | 108 lm/W | 98 W | 1999.90 |
| 1,800 mm | 13527163 | 13527173 | 13527183 | 3,000 K | opal | switchable | 12,293 lm | 102 lm/W | 120 W | 2599.90 |
| | 13527164 | 13527174 | 13527184 | 4,000 K | opal | switchable | 12,960 lm | 108 lm/W | 120 W | 2599.90 |
| | 13537163 | 13537173 | 13537183 | 3,000 K | opal | DALI | 12,293 lm | 102 lm/W | 120 W | 2899.90 |
| | 13537164 | 13537174 | 13537184 | 4,000 K | opal | DALI | 12,960 lm | 108 lm/W | 120 W | 2899.90 |
| 2,000 mm | 13526163 | 13526173 | 13526183 | 3,000 K | opal | switchable | 13,536 lm | 101 lm/W | 134 W | 2899.90 |
| | 13526164 | 13526174 | 13526184 | 4,000 K | opal | switchable | 14,270 lm | 106 lm/W | 134 W | 2899.90 |
| | 13536163 | 13536173 | 13536183 | 3,000 K | opal | DALI | 13,536 lm | 101 lm/W | 134 W | 3299.90 |
| | 13536164 | 13536174 | 13536184 | 4,000 K | opal | DALI | 14,270 lm | 106 lm/W | 134 W | 3299.90 |
| 2,500 mm | 13528163 | 13528173 | 13528183 | 3,000 K | opal | switchable | 16,885 lm | 102 lm/W | 166 W | 3499.90 |
| | 13528164 | 13528174 | 13528184 | 4,000 K | opal | switchable | 17,800 lm | 107 lm/W | 166 W | 3499.90 |
| | 13538163 | 13538173 | 13538183 | 3,000 K | opal | DALI | 16,885 lm | 102 lm/W | 166 W | 3999.90 |
| | 13538164 | 13538174 | 13538184 | 4,000 K | opal | DALI | 17,800 lm | 107 lm/W | 166 W | 3999.90 |



Also available in: TunableWhite & Casambi

These items are subject to discount group 2.

Sizes in mm | All prices are recommended retail prices (RRP) in euros without VAT. Errors excepted. | Orders are placed in accordance with our General Terms and Conditions of Sale printed on page 486 onwards.

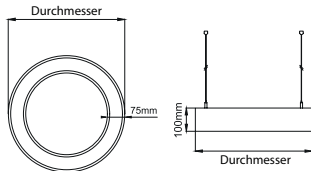

Lamp: LED, input voltage: 220 – 240 V AC, 50 – 60 Hz, colour rendering: CRI > 80, cover: PC, opal, material: aluminium / steel / plastic, pendant length: 5,000 mm

Supply:
 Ø 450 mm incl. central canopy,
 Ø 600 mm to Ø 2,500 mm incl. decentralised canopy
 (central canopy on request)

Service life:
 L90/B10, 74,000 hrs. (ta: +25 °C)

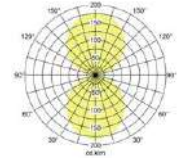

Height 100 mm

BIRO CIRCLE pendant ring light, direct/indirect

NEW

| Diameter | Article no. textured silver | Article no. textured white | Article no. textured black | Colour temp. | Cover | Control | Luminous flux | System efficiency | System power | Price in € |
|----------|-----------------------------|----------------------------|----------------------------|--------------|-------|-------------|---------------|-------------------|--------------|------------|
| 450 mm | 13545163 | 13545173 | 13545183 | 3,000 K | opal | switchable | 4,609 lm | 102 lm/W | 45 W | 789.90 |
| | 13545164 | 13545174 | 13545184 | 4,000 K | opal | switchable | 4,860 lm | 108 lm/W | 45 W | 789.90 |
| | 13555163 | 13555173 | 13555183 | 3,000 K | opal | DALI | 4,609 lm | 102 lm/W | 45 W | 899.90 |
| | 13555164 | 13555174 | 13555184 | 4,000 K | opal | DALI | 4,860 lm | 108 lm/W | 45 W | 899.90 |
| 600 mm | 13540163 | 13540173 | 13540183 | 3,000 K | opal | switchable | 6,145 lm | 102 lm/W | 60 W | 999.90 |
| | 13540164 | 13540174 | 13540184 | 4,000 K | opal | switchable | 6,480 lm | 108 lm/W | 60 W | 999.90 |
| | 13550163 | 13550173 | 13550183 | 3,000 K | opal | DALI | 6,145 lm | 102 lm/W | 60 W | 1149.90 |
| | 13550164 | 13550174 | 13550184 | 4,000 K | opal | DALI | 6,480 lm | 108 lm/W | 60 W | 1149.90 |
| 750 mm | 13541163 | 13541173 | 13541183 | 3,000 K | opal | switchable | 7,683 lm | 102 lm/W | 75 W | 1229.90 |
| | 13541164 | 13541174 | 13541184 | 4,000 K | opal | switchable | 8,100 lm | 108 lm/W | 75 W | 1229.90 |
| | 13551163 | 13551173 | 13551183 | 3,000 K | opal | DALI | 7,683 lm | 102 lm/W | 75 W | 1339.90 |
| | 13551164 | 13551174 | 13551184 | 4,000 K | opal | DALI | 8,100 lm | 108 lm/W | 75 W | 1339.90 |
| 1,000 mm | 13542163 | 13542173 | 13542183 | 3,000 K | opal | switchable | 10,214 lm | 104 lm/W | 98 W | 1659.90 |
| | 13542164 | 13542174 | 13542184 | 4,000 K | opal | switchable | 10,769 lm | 110 lm/W | 98 W | 1659.90 |
| | 13552163 | 13552173 | 13552183 | 3,000 K | opal | DALI | 10,214 lm | 104 lm/W | 98 W | 1999.90 |
| | 13552164 | 13552174 | 13552184 | 4,000 K | opal | DALI | 10,769 lm | 110 lm/W | 98 W | 1999.90 |
| 1,200 mm | 13543163 | 13543173 | 13543183 | 3,000 K | opal | switchable | 12,234 lm | 104 lm/W | 117 W | 1999.90 |
| | 13543164 | 13543174 | 13543184 | 4,000 K | opal | switchable | 12,900 lm | 110 lm/W | 117 W | 1999.90 |
| | 13553163 | 13553173 | 13553183 | 3,000 K | opal | DALI | 12,234 lm | 104 lm/W | 117 W | 2199.90 |
| | 13553164 | 13553174 | 13553184 | 4,000 K | opal | DALI | 12,900 lm | 110 lm/W | 117 W | 2199.90 |
| 1,500 mm | 13544163 | 13544173 | 13544183 | 3,000 K | opal | switchable | 15,365 lm | 104 lm/W | 147 W | 2499.90 |
| | 13544164 | 13544174 | 13544184 | 4,000 K | opal | switchable | 16,199 lm | 110 lm/W | 147 W | 2499.90 |
| | 13554163 | 13554173 | 13554183 | 3,000 K | opal | DALI | 15,365 lm | 104 lm/W | 147 W | 2799.90 |
| | 13554164 | 13554174 | 13554184 | 4,000 K | opal | DALI | 16,199 lm | 110 lm/W | 147 W | 2799.90 |
| 1,800 mm | 13547163 | 13547173 | 13547183 | 3,000 K | opal | switchable | 18,589 lm | 103 lm/W | 180 W | 3699.90 |
| | 13547164 | 13547174 | 13547184 | 4,000 K | opal | switchable | 19,597 lm | 108 lm/W | 180 W | 3699.90 |
| | 13557163 | 13557173 | 13557183 | 3,000 K | opal | DALI | 18,589 lm | 103 lm/W | 180 W | 4399.90 |
| | 13557164 | 13557174 | 13557184 | 4,000 K | opal | DALI | 19,597 lm | 108 lm/W | 180 W | 4399.90 |
| 2,000 mm | 13546163 | 13546173 | 13546183 | 3,000 K | opal | switchable | 20,488 lm | 102 lm/W | 201 W | 3999.90 |
| | 13546164 | 13546174 | 13546184 | 4,000 K | opal | switchable | 21,600 lm | 107 lm/W | 201 W | 3999.90 |
| | 13556163 | 13556173 | 13556183 | 3,000 K | opal | DALI | 20,488 lm | 102 lm/W | 201 W | 4799.90 |
| | 13556164 | 13556174 | 13556184 | 4,000 K | opal | DALI | 21,600 lm | 107 lm/W | 201 W | 4799.90 |
| 2,500 mm | 13548163 | 13548173 | 13548183 | 3,000 K | opal | switchable | 25,374 lm | 102 lm/W | 249 W | 4899.90 |
| | 13548164 | 13548174 | 13548184 | 4,000 K | opal | switchable | 26,850 lm | 108 lm/W | 249 W | 4899.90 |
| | 13558163 | 13558173 | 13558183 | 3,000 K | opal | DALI | 25,374 lm | 102 lm/W | 249 W | 5999.90 |
| | 13558164 | 13558174 | 13558184 | 4,000 K | opal | DALI | 26,850 lm | 108 lm/W | 249 W | 5999.90 |



Also available in: TunableWhite, RGBW & Casambi

These items are subject to discount group 2.



Bucher_Tower, Rottweil

FRANKFURT AIRPORT LIGHTING MOOD WITH BIRO CIRCLE.

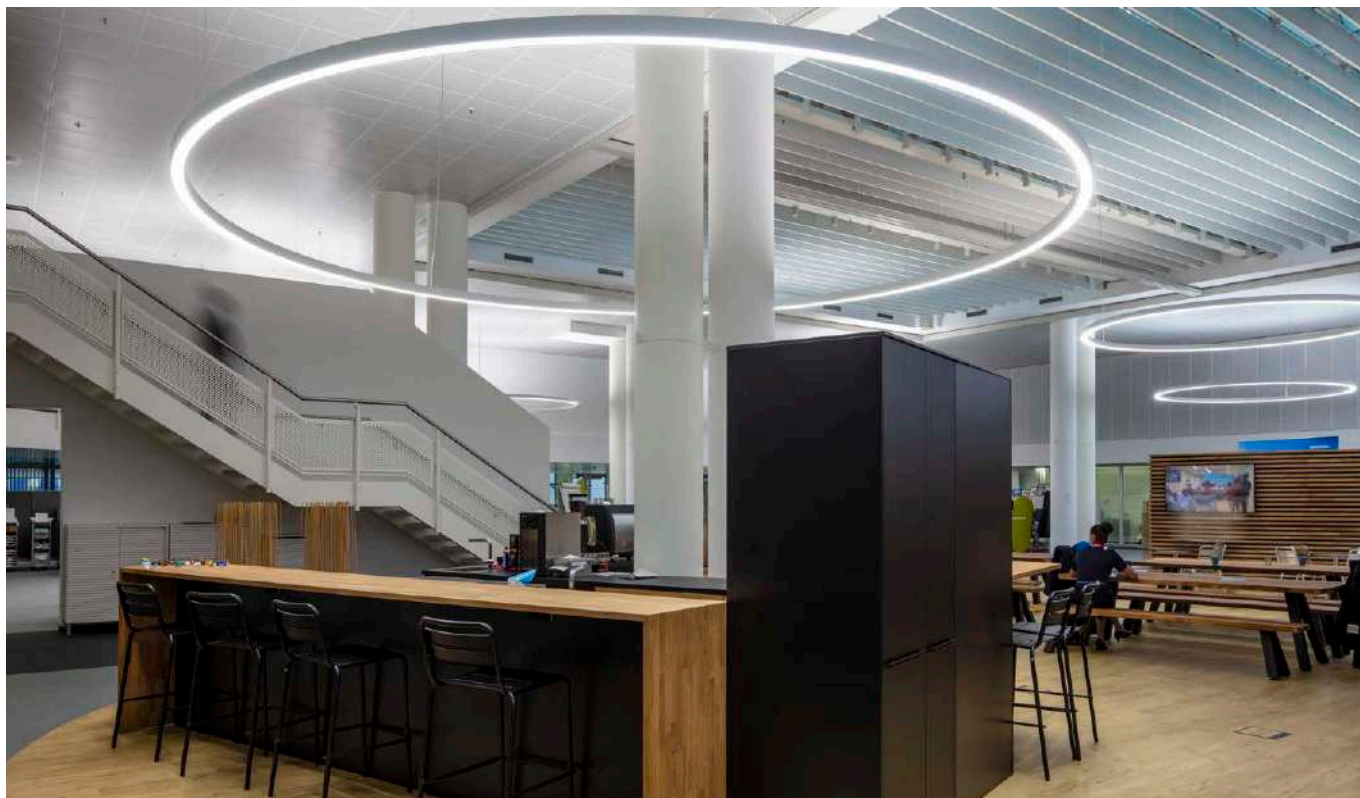

Many things have to happen faster at the airport than anywhere else. The Brumberg crew also had to deliver everything “on time” for the realisation of the new lighting system for an office space at Frankfurt Airport. The quick start: enquiry to Brumberg by Lampenwelt Berlin, two telephone meetings with the technical planner, preparation and submission of the quotation, provision of two fitters, go!

The light of the rings.

The order: lighting that is pleasant and controllable for employees in a large office that receives little daylight. The requirement was therefore for optimum light distribution with a colour ranging from warm white to daylight white and – in line with the Brumberg philosophy – a lighting solution that not only matched the function of the premises, but also the requirements of the people working there and the industry. What could be better suited to aviation than floating ring lights? More precisely, the BIRO CIRCLE pendant ring lights, whose properties are ideal for this task: direct and indirect lighting, rotationally symmetrical narrow-wide beam light distribution and light distribution through a microprismatic plastic cover.





Skill time.

As soon as all the DALI drivers per ring size, the appropriate DALI gateway and the CCT control system had been included in the planning, the luminaires could be installed under the ceiling – 13 ring luminaires with a luminaire diameter of 2,500 mm to 6,000 mm were mounted at different heights and adapted to the room architecture. A few more skilful moves and the goal of the quick-start mission was achieved. And that with two successes:

Firstly, the ideal lighting design for an open-plan office and secondly, an ambience that could switch from contemporary to futuristic. Those who work here have to deal with flights and aeroplanes on a daily basis and may now occasionally imagine themselves travelling through time in an intergalactic spaceship. In any case, the project deserves an honourable mention for the fact that the customer was not only satisfied in a short space of time, but also delighted.



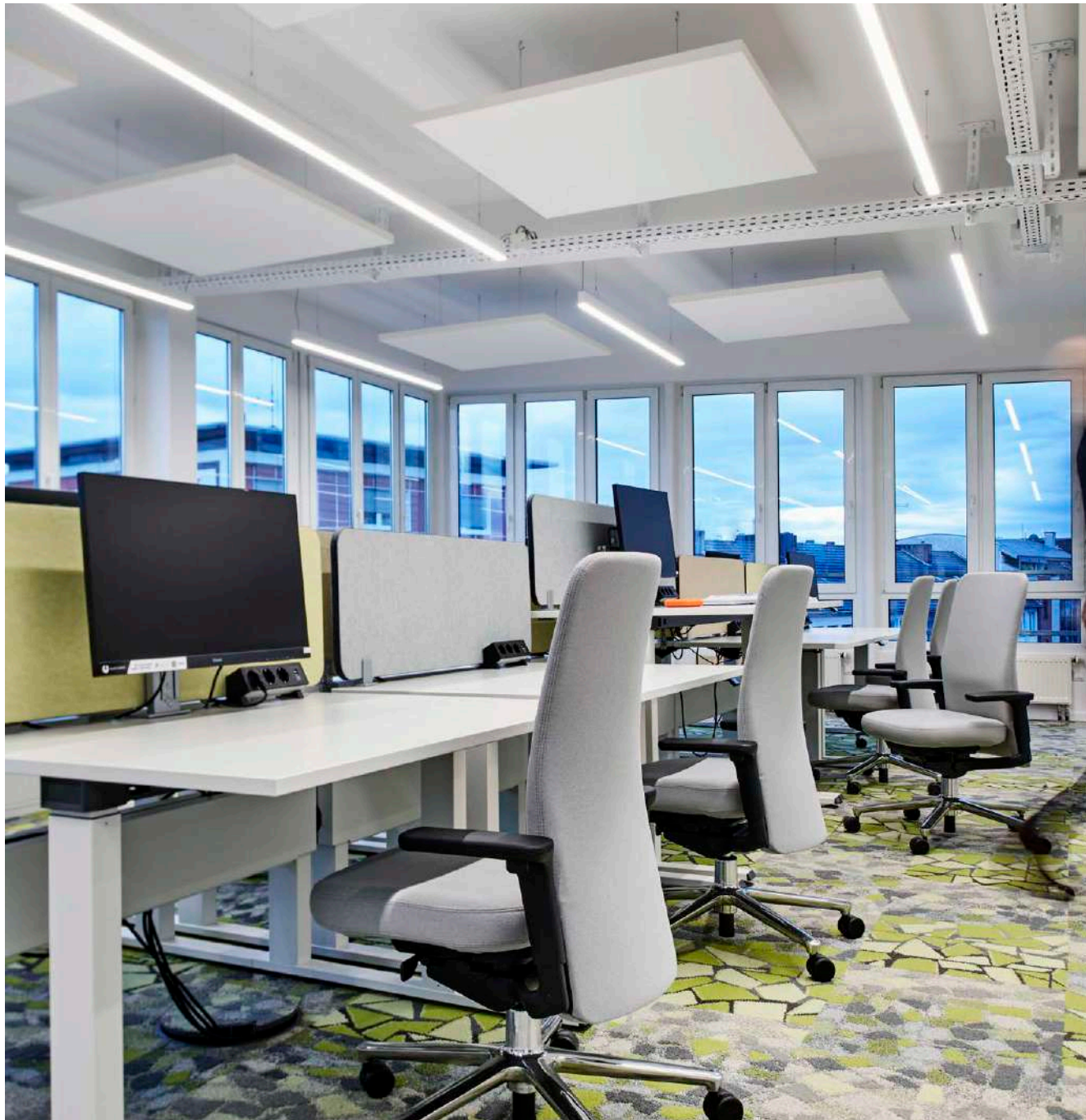

BIR040 lighting channel system configurator.

Individuality. Easy to plan.

With the new BIR040 light channel system configurator, you can configure your Brumberg light channel quickly and conveniently. First select the desired mounting type, colour, colour temperature, control and the corresponding cover. Special shapes can also be configured. At the end, you will receive a detailed planning overview.

Start your configuration now: www.brumberg.com

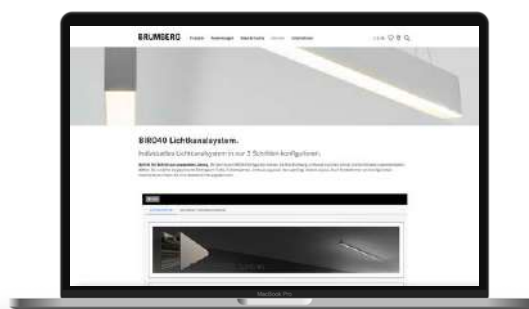

BIRO40.

One profile, three applications.

1. Recessed.

Suitable for recessed ceiling mounting. Recessed profiles made of torsion-resistant aluminium with an extremely narrow luminaire body measuring 40 x 65 mm.

2. Surface-mounted.

Suitable for ceiling and wall mounting. Profiles made of torsion-resistant aluminium with an extremely narrow luminaire body measuring 40 x 75 mm.

3. Pendant. Direct or direct / indirect.

Suitable for pendant mounting. Profiles made of torsion-resistant aluminium with an extremely narrow luminaire body measuring 40 x 75 mm.

Realise lighting solutions with the right geometries.

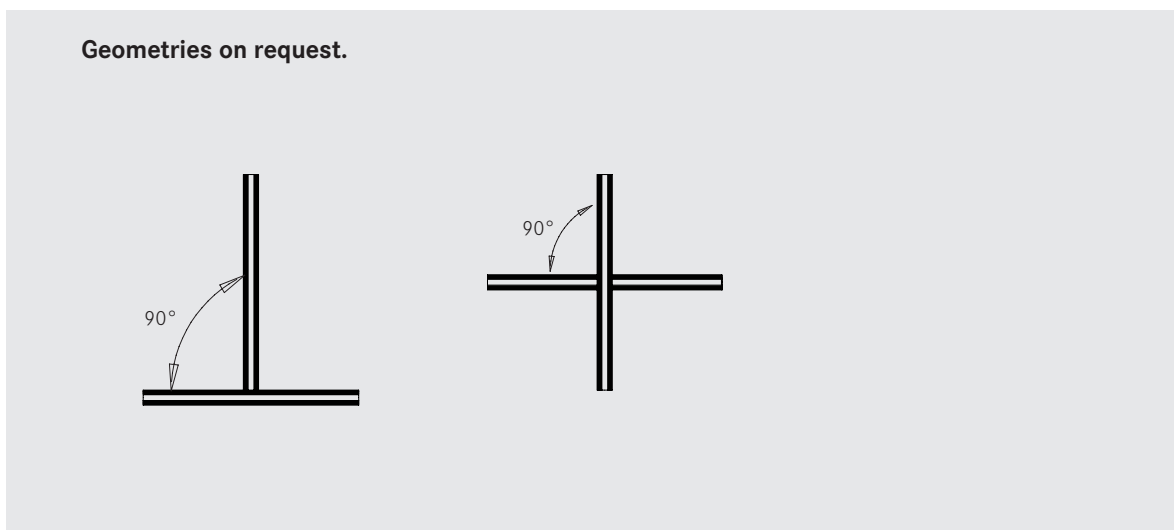
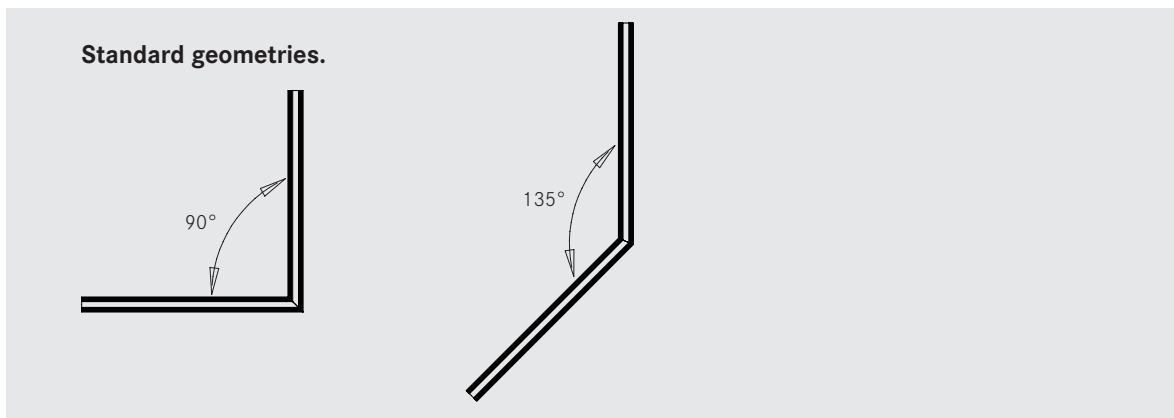

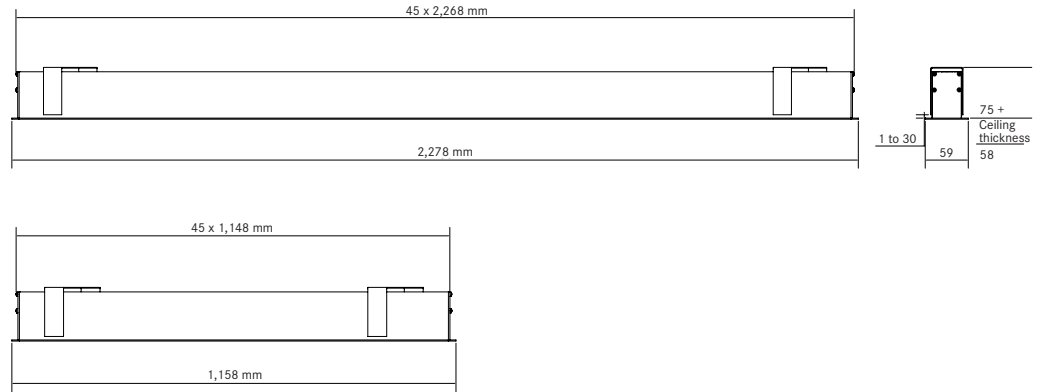

BIRO40 LED recessed profile, standard lengths

Colour rendering:

CRI > 90, TunableWhite CRI > 80

Service life:

3,000 K & 4,000 K: L80/B10, > 60,000 hrs. (ta: +25 °C)

2,700 K - 6,500 K (TW): L80/B50, > 70,000 hrs. (ta: +25 °C)

satinised

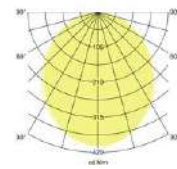

Microprism

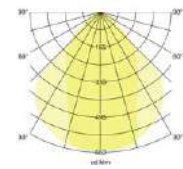

glossy white



matt black



matt silver

| Article no. silver matt anodised | Article no. glossy white | Article no. black matt anodised | Length | Colour temp. | Cover | UGR | Control | Luminous flux | System efficiency | System power | Price in € |
|----------------------------------|--------------------------|---------------------------------|----------|-------------------|------------|------|-------------------|---------------|-------------------|--------------|------------|
| 77033693 | 77033073 | 77033083 | 1,158 mm | 3,000 K | satinised | < 25 | DALI | 2,430 lm | 78 lm/W | 31 W | 389.90 |
| 77033694 | 77033074 | 77033084 | 1,158 mm | 4,000 K | satinised | < 25 | DALI | 2,740 lm | 87 lm/W | 31 W | 409.90 |
| 77033698 | 77033078 | 77033088 | 1,158 mm | 2,700 K - 6,500 K | satinised | < 25 | DALI (DT8) | 2,690 lm | 86 lm/W | 31 W | 609.90 |
| 77034693 | 77034073 | 77034083 | 2,278 mm | 3,000 K | satinised | < 25 | DALI | 4,840 lm | 77 lm/W | 62 W | 659.90 |
| 77034694 | 77034074 | 77034084 | 2,278 mm | 4,000 K | satinised | < 25 | DALI | 5,470 lm | 87 lm/W | 62 W | 659.90 |
| 77034698 | 77034078 | 77034088 | 2,278 mm | 2,700 K - 6,500 K | satinised | < 25 | DALI (DT8) | 5,380 lm | 86 lm/W | 62 W | 869.90 |
| 77023693 | 77023073 | 77023083 | 1,158 mm | 3,000 K | microprism | < 19 | DALI | 1,430 lm | 80 lm/W | 18 W | 409.90 |
| 77023694 | 77023074 | 77023084 | 1,158 mm | 4,000 K | microprism | < 19 | DALI | 1,620 lm | 90 lm/W | 18 W | 409.90 |
| 77023698 | 77023078 | 77023088 | 1,158 mm | 2,700 K - 6,500 K | microprism | < 19 | DALI (DT8) | 1,590 lm | 89 lm/W | 18 W | 619.90 |
| 77024693 | 77024073 | 77024083 | 2,278 mm | 3,000 K | microprism | < 19 | DALI | 2,860 lm | 80 lm/W | 36 W | 689.90 |
| 77024694 | 77024074 | 77024084 | 2,278 mm | 4,000 K | microprism | < 19 | DALI | 3,230 lm | 90 lm/W | 36 W | 689.90 |
| 77024698 | 77024078 | 77024088 | 2,278 mm | 2,700 K - 6,500 K | microprism | < 19 | DALI (DT8) | 3,180 lm | 89 lm/W | 36 W | 899.90 |

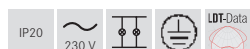

These items are subject to discount group 2.

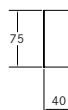
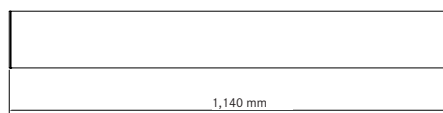
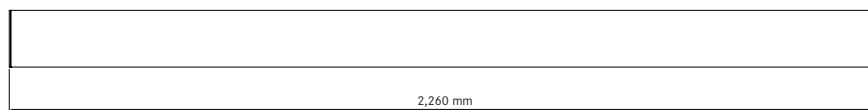

BIRO40 LED surface-mounted profile, standard lengths

NEW

Colour rendering:

CRI > 90, TunableWhite CRI > 80

Service life:

3,000 K & 4,000 K: L80/B10, > 60,000 hrs. (ta: +25 °C)
2,700 K – 6,500 K (TW): L80/B50, > 70,000 hrs. (ta: +25 °C)

satinised

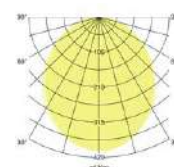

Microprism

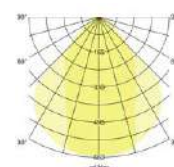

glossy white



matt black



matt silver

| Article no. silver matt anodised | NEW Article no. glossy white | Article no. black matt anodised | Length | Colour temp. | Cover | UGR | Control | Luminous flux | System efficiency | System power | Price in € |
|----------------------------------|---------------------------------|---------------------------------|----------|-------------------|------------|------|-------------------|---------------|-------------------|--------------|------------|
| 77143693 | 77143073 | 77143083 | 1,140 mm | 3,000 K | satinised | < 25 | DALI | 2,430 lm | 78 lm/W | 31 W | 359.90 |
| 77143694 | 77143074 | 77143084 | 1,140 mm | 4,000 K | satinised | < 25 | DALI | 2,740 lm | 87 lm/W | 31 W | 459.90 |
| 77143698 | 77143078 | 77143088 | 1,140 mm | 2,700 K – 6,500 K | satinised | < 25 | DALI (DT8) | 2,690 lm | 86 lm/W | 31 W | 579.90 |
| 77144693 | 77144073 | 77144083 | 2,260 mm | 3,000 K | satinised | < 25 | DALI | 4,840 lm | 77 lm/W | 62 W | 619.90 |
| 77144694 | 77144074 | 77144084 | 2,260 mm | 4,000 K | satinised | < 25 | DALI | 5,470 lm | 87 lm/W | 62 W | 619.90 |
| 77144698 | 77144078 | 77144088 | 2,260 mm | 2,700 K – 6,500 K | satinised | < 25 | DALI (DT8) | 5,380 lm | 86 lm/W | 62 W | 839.90 |
| 77133693 | 77133073 | 77133083 | 1,140 mm | 3,000 K | microprism | < 19 | DALI | 1,430 lm | 80 lm/W | 18 W | 369.90 |
| 77133694 | 77133074 | 77133084 | 1,140 mm | 4,000 K | microprism | < 19 | DALI | 1,620 lm | 90 lm/W | 18 W | 369.90 |
| 77133698 | 77133078 | 77133088 | 1,140 mm | 2,700 K – 6,500 K | microprism | < 19 | DALI (DT8) | 1,590 lm | 89 lm/W | 18 W | 539.90 |
| 77134693 | 77134073 | 77134083 | 2,260 mm | 3,000 K | microprism | < 19 | DALI | 2,860 lm | 80 lm/W | 36 W | 649.90 |
| 77134694 | 77134074 | 77134084 | 2,260 mm | 4,000 K | microprism | < 19 | DALI | 3,230 lm | 90 lm/W | 36 W | 649.90 |
| 77134698 | 77134078 | 77134088 | 2,260 mm | 2,700 K – 6,500 K | microprism | < 19 | DALI (DT8) | 3,180 lm | 89 lm/W | 36 W | 859.90 |

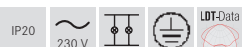

These items are subject to discount group 2.

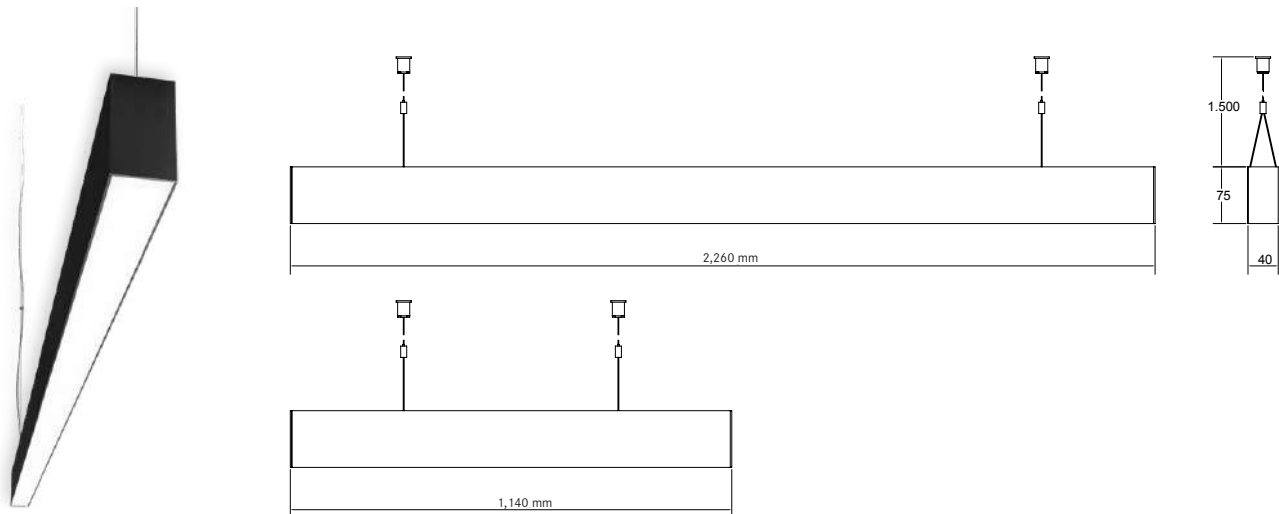

BIRO40 LED pendant profile, standard lengths

NEW

Colour rendering:

CRI > 90, TunableWhite CRI > 80

Service life:

3,000 K & 4,000 K: L80/B10, > 60,000 hrs. (ta: +25 °C)

2,700 K - 6,500 K (TW): L80/B50, > 70,000 hrs. (ta: +25 °C)

satinised

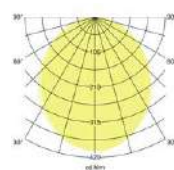

Microprism

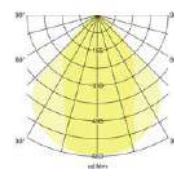

glossy white



matt black



matt silver

| Article no. silver matt anodised | NEW Article no. glossy white | Article no. black matt anodised | Length | Colour temp. | Cover | UGR | Control | Luminous flux | System efficiency | System power | Price in € |
|----------------------------------|---------------------------------|---------------------------------|----------|-------------------|------------|------|-------------------|---------------|-------------------|--------------|------------|
| 77243693 | 77243073 | 77243083 | 1,140 mm | 3,000 K | satinised | < 25 | DALI | 2,430 lm | 78 lm/W | 31 W | 469.90 |
| 77243694 | 77243074 | 77243084 | 1,140 mm | 4,000 K | satinised | < 25 | DALI | 2,740 lm | 87 lm/W | 31 W | 469.90 |
| 77243698 | 77243078 | 77243088 | 1,140 mm | 2,700 K - 6,500 K | satinised | < 25 | DALI (DT8) | 2,690 lm | 86 lm/W | 31 W | 639.90 |
| 77244693 | 77244073 | 77244083 | 2,260 mm | 3,000 K | satinised | < 25 | DALI | 4,840 lm | 77 lm/W | 62 W | 739.90 |
| 77244694 | 77244074 | 77244084 | 2,260 mm | 4,000 K | satinised | < 25 | DALI | 5,470 lm | 87 lm/W | 62 W | 739.90 |
| 77244698 | 77244078 | 77244088 | 2,260 mm | 2,700 K - 6,500 K | satinised | < 25 | DALI (DT8) | 5,380 lm | 86 lm/W | 62 W | 949.90 |
| 77233693 | 77233073 | 77233083 | 1,140 mm | 3,000 K | microprism | < 19 | DALI | 1,430 lm | 80 lm/W | 18 W | 489.90 |
| 77233694 | 77233074 | 77233084 | 1,140 mm | 4,000 K | microprism | < 19 | DALI | 1,620 lm | 90 lm/W | 18 W | 489.90 |
| 77233698 | 77233078 | 77233088 | 1,140 mm | 2,700 K - 6,500 K | microprism | < 19 | DALI (DT8) | 1,590 lm | 89 lm/W | 18 W | 659.90 |
| 77234693 | 77234073 | 77234083 | 2,260 mm | 3,000 K | microprism | < 19 | DALI | 2,860 lm | 80 lm/W | 36 W | 759.90 |
| 77234694 | 77234074 | 77234084 | 2,260 mm | 4,000 K | microprism | < 19 | DALI | 3,230 lm | 90 lm/W | 36 W | 759.90 |
| 77234698 | 77234078 | 77234088 | 2,260 mm | 2,700 K - 6,500 K | Microprism | < 19 | DALI (DT8) | 3,180 lm | 89 lm/W | 36 W | 979.90 |

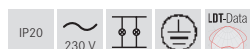

These items are subject to discount group 2.

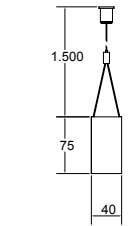
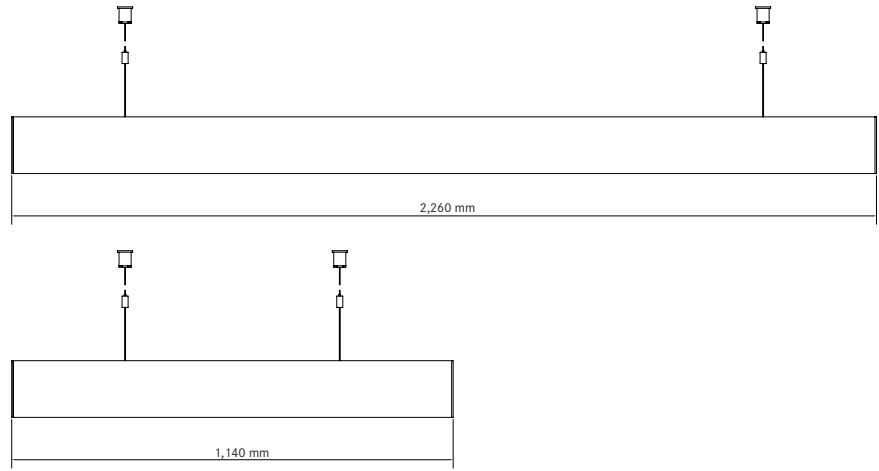
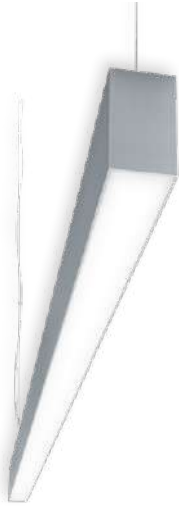

Eligible for BEG

BIRO40 LED pendant profile direct/indirect, standard lengths

NEW

Colour rendering: CRI > 90, TunableWhite CRI > 80

Service life:

3,000 K & 4,000 K: L80/B10, > 60,000 hrs. (ta: +25 °C)
2,700 K – 6,500 K (TW): L80/B50, > 70,000 hrs. (ta: +25 °C)

satinised

Microprism

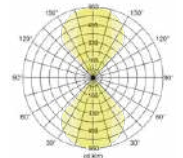
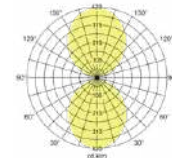

glossy white



matt black



matt silver

| Article no. silver matt anodised | NEW Article no. glossy white | Article no. black matt anodised | Length | Colour temp. | Cover | UGR | Control | Luminous flux | System efficiency | System power | Price in € |
|----------------------------------|---------------------------------|---------------------------------|----------|-------------------|------------|------|------------|---------------|-------------------|--------------|------------|
| 77353693 | 77353073 | 77353083 | 1,140 mm | 3,000 K | satinised | < 25 | DALI | 4,970 lm | 108 lm/W | 46 W | 579.90 |
| 77353694 | 77353074 | 77353084 | 1,140 mm | 4,000 K | satinised | < 25 | DALI | 5,600 lm | 122 lm/W | 46 W | 579.90 |
| 77353698 | 77353078 | 77353088 | 1,140 mm | 2,700 K – 6,500 K | satinised | < 25 | DALI (DT8) | 5,520 lm | 120 lm/W | 46 W | 749.90 |
| 77354693 | 77354073 | 77354083 | 2,260 mm | 3,000 K | satinised | < 25 | DALI | 10,260 lm | 108 lm/W | 95 W | 939.90 |
| 77354694 | 77354074 | 77354084 | 2,260 mm | 4,000 K | satinised | < 25 | DALI | 11,580 lm | 122 lm/W | 95 W | 939.90 |
| 77354698 | 77354078 | 77354088 | 2,260 mm | 2,700 K – 6,500 K | satinised | < 25 | DALI (DT8) | 11,400 lm | 120 lm/W | 95 W | 1269.90 |
| 77333693 | 77333073 | 77333083 | 1,140 mm | 3,000 K | microprism | < 19 | DALI | 5,060 lm | 110 lm/W | 46 W | 589.90 |
| 77333694 | 77333074 | 77333084 | 1,140 mm | 4,000 K | microprism | < 19 | DALI | 5,720 lm | 124 lm/W | 46 W | 589.90 |
| 77333698 | 77333078 | 77333088 | 1,140 mm | 2,700 K – 6,500 K | microprism | < 19 | DALI (DT8) | 5,630 lm | 122 lm/W | 46 W | 759.90 |
| 77334693 | 77334073 | 77334083 | 2,260 mm | 3,000 K | microprism | < 19 | DALI | 10,460 lm | 110 lm/W | 95 W | 969.90 |
| 77334694 | 77334074 | 77334084 | 2,260 mm | 4,000 K | microprism | < 19 | DALI | 11,810 lm | 124 lm/W | 95 W | 969.90 |
| 77334698 | 77334078 | 77334088 | 2,260 mm | 2,700 K – 6,500 K | microprism | < 19 | DALI (DT8) | 11,620 lm | 122 lm/W | 95 W | 1299.90 |

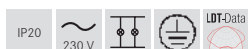

These items are subject to discount group 2.

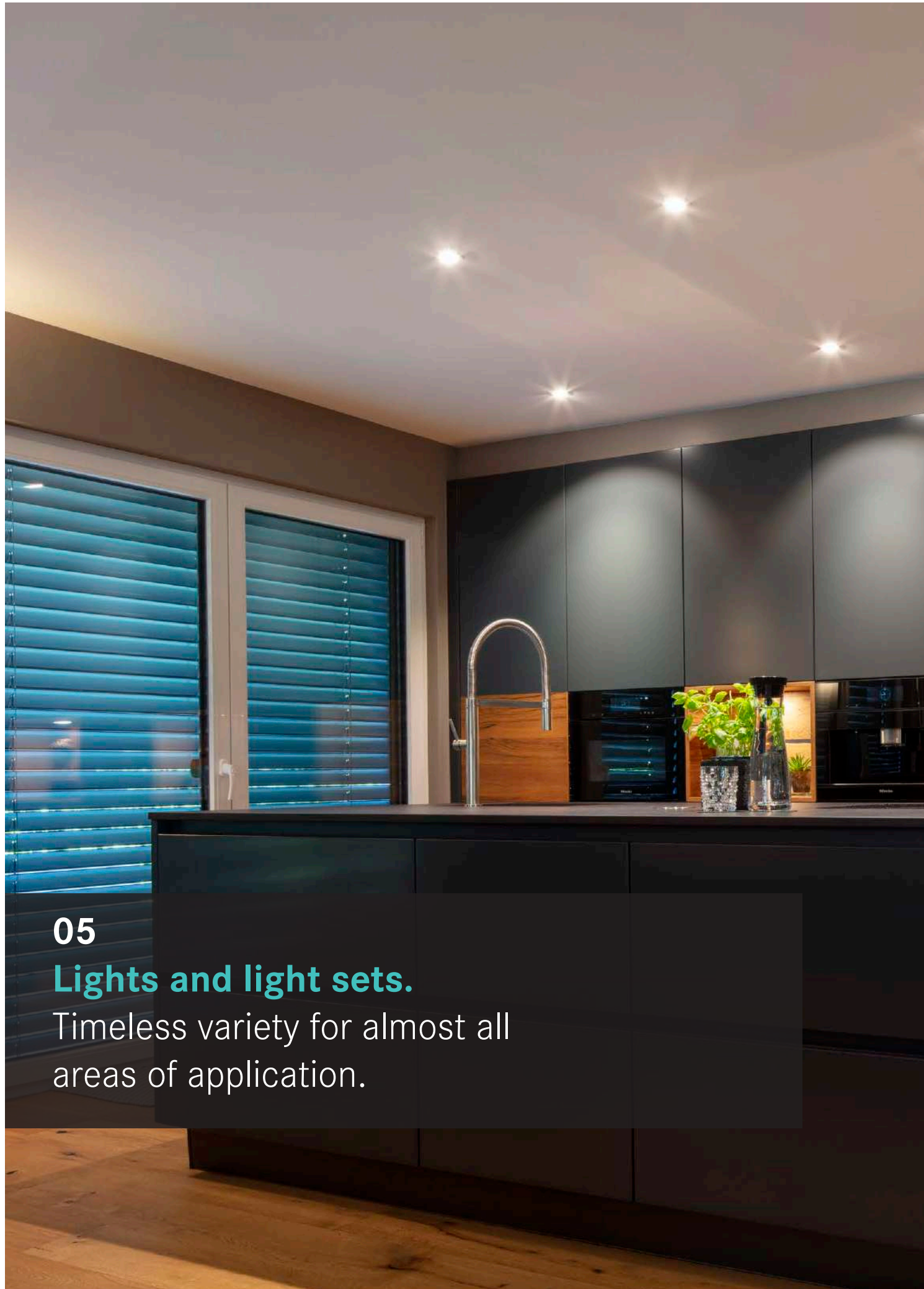

05

Lights and light sets.

Timeless variety for almost all areas of application.





Frank Lamontagne
Head of Marketing & Sales | Authorised signatory

All in LOOP.

Another look at relevant value propositions for customers: cost, safety, applicability and service. LOOP scores highly in the first area with its sustainable, cost-saving LED technology. According to Brumberg, the easy installation and maintenance, the intuitive use and the long availability of the products offer safety and practicality. “All of this is part of our philosophy. Our customers can also fully rely on a sustainable product like LOOP”, assures Frank Lamontagne, Sales Manager at Brumberg. Installers and craftsmen expect at least consistent quality and applicability from a supplier like Brumberg. Can a sustainable product like LOOP achieve this? “LOOP sets new standards for sustainable lighting solutions on the global market that combine aesthetics with high quality and functionality”, says Frank Lamontagne.

LOOP makes it.

And what is the demand like? According to Frank Lamontagne, it is encouragingly high: “Sustainability is not just a fleeting trend. If our dealers and installers can now offer recyclable Brumberg products in addition to efficient ones, it is another very good value proposition. For their part, customers can present their new lighting system with a clear conscience. Everyone wins, including the environment.”

re:think re:spect re:cycle re:use

LOOP[®]

Light Of Ocean Plastic.

The first certified LED recessed luminaire housing made from 100% Recycled Ocean Plastic.

Plastic waste in the sea is a global catastrophe that we need to do something about. We contribute to this with the first luminaire whose plastic content consists of 100 per cent "Recycled Ocean Plastic". LOOP[®] sets new standards for sustainable lighting solutions on the global market that combine aesthetics with high quality and functionality. Sustainability is not just a fleeting trend. For more and more consumers, this is an important factor in their purchasing decisions.



re:think

According to an initial estimate, 4.8 to 12.7 million tonnes of plastic waste end up in the sea every year – the equivalent of around one lorry load per minute. Fishing nets also damage the fauna and flora of our oceans and take up to 6 centuries to completely dissolve. One way to offset at least some of the pollution is to collect and recycle this carelessly discarded raw material.



re:spect

The LOOP[®] LED recessed spotlight fulfils our aim of offering a luminaire that is not only energy-efficient but also sustainable in its components. It is important to look at the bigger picture: for future generations. For us, sustainability means finding the right balance between ecology, economy and social responsibility for the future and making it an integral part of the company.



re:cycle

For example, the path to reusable, high-quality plastic begins with the collection of discarded fishing nets from beaches and coasts. These are then cleaned, sorted, shredded and processed into recycled polyamide. It results in a material that meets the highest quality standards and is used primarily in high-tech applications.



re:use

The ceiling recessed spotlight offers maximum scope for flexibility. Depending on your lighting requirements, you can choose from over 30 different LED modules with a wide range of technologies from our company. Customers can also choose the LOOP[®] set. It includes the ocean-plastic housing, phase-dimmable converter with ocean-plastic converter housing and 5 W LED module with 3,000 K. Important for an overall positive environmental balance: all parts of the light are recyclable and even the packaging is eco-friendly thanks to plastic-free materials.

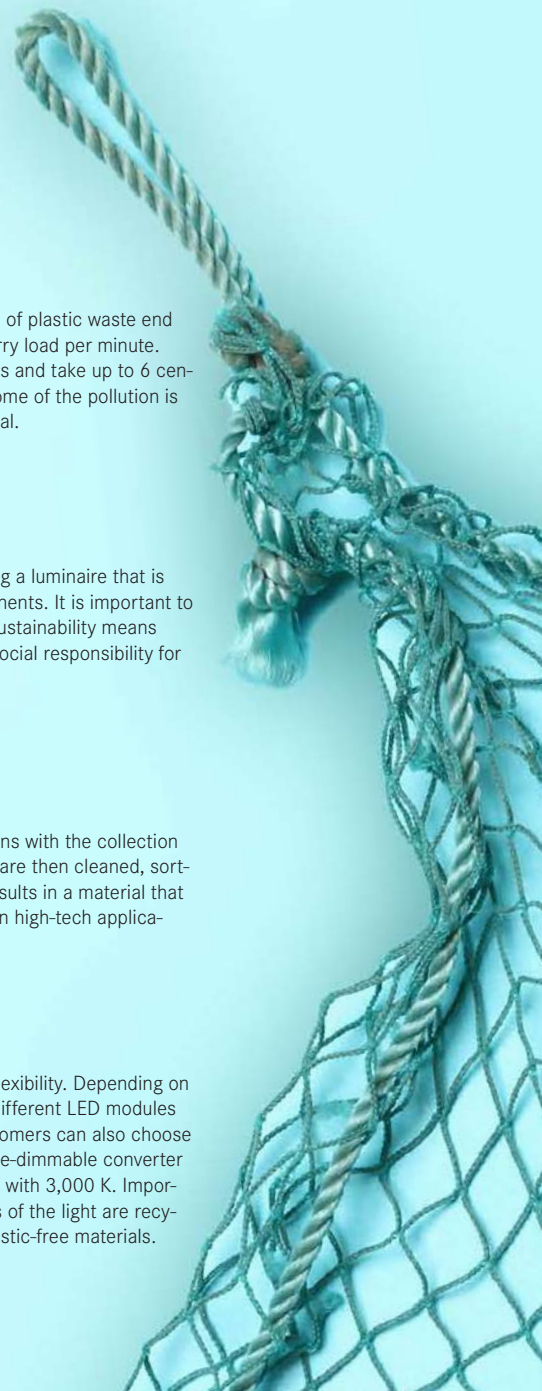

LOOP®. Thinking sustainability further.

100% recycled and recyclable luminaire housing with highly efficient LED technology in a modern and elegant design.



- **4 pre-assembled dimmable standard sets**

Including bracket, LED module (CRI > 90) and converter.
Quick and easy installation.

- **4 installation housings**

Can be combined in 2 colours and 2 shapes with over 30 interchangeable LED modules.

- **As requested: can always be swivelled 20°.**

- **L80/B20 at 25 °C 50,000 h**

Modern and high-quality LED technology.

- **Simple and modern look**

No snap ring.

- **100% recycled**

Recycled and recyclable.

All in all: fully sustainable in terms of materials and efficiency.

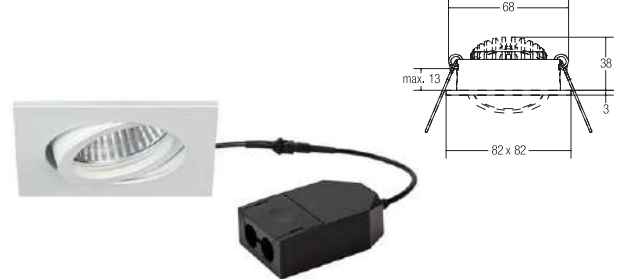
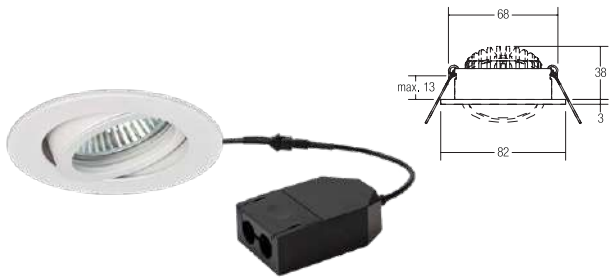

LOOP®-R LED recessed spotlight set, trailing-edge phase dimmable

Set incl. converter for 230 V mains voltage, trailing-edge phase dimmable, converter dimensions: L 80 x W 45 x H 23 mm (Converter housing also made of Ocean Plastic Material)

Lamp: LED, colour rendering: CRI > 90, power: 5 W, beam angle: 38°, material: nylon / magnesium hydroxide / fibreglass

| Article no. | Colour | Lumin. flux | Colour temp. | Price in € |
|-------------|----------------|-------------|--------------|------------|
| 39383173 | textured white | 450 lm | 3,000 K | 57.70 |
| 39383183 | textured black | 450 lm | 3,000 K | 57.70 |

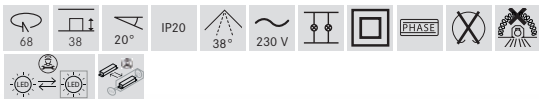

These items are subject to discount group 1.

LOOP®-S LED recessed spotlight set, trailing-edge phase dimmable

Set incl. converter for 230 V mains voltage, trailing-edge phase dimmable, converter dimensions: L 80 x W 45 x H 23 mm (Converter housing also made of Ocean Plastic Material)

Lamp: LED, colour rendering: CRI > 90, power: 5 W, beam angle: 38°, material: nylon / magnesium hydroxide / fibreglass

| Article no. | Colour | Lumin. flux | Colour temp. | Price in € |
|-------------|----------------|-------------|--------------|------------|
| 39385173 | textured white | 450 lm | 3,000 K | 59.00 |
| 39385183 | textured black | 450 lm | 3,000 K | 59.00 |

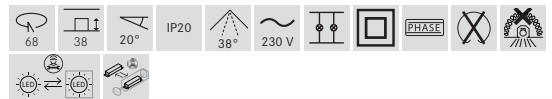

These items are subject to discount group 1.



“We have opted for the **RCS (Recycled Claim Standard)** – a standard for the traceability of recycled raw materials within a supply chain. We can therefore be sure that only Ocean Plastic is used for our LOOP® product.”

- Manfred Goeke, product management



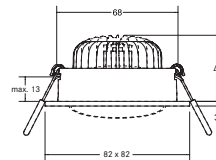
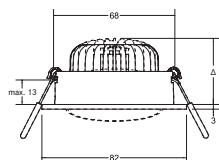

LOOP®-R Recessed spotlight housing, without LED module

All Brumberg MR16 LED modules can be used for the LOOP installation unit. The installation depth of the luminaire depends on the LED module used (here: 5 mm, plus the height of the LED module). The LED module is not included in the scope of supply of the installation unit.

Lamp: for LED, power: max. 14 W, material: nylon / magnesium hydroxide / fibreglass

You can find the corresponding LED modules on page 194. An overview of suitable power supply units can be found on page 202.

| Article no. | Colour | Price in € |
|-------------|----------------|------------|
| 27063170 | textured white | 28.80 |
| 27063180 | textured black | 28.80 |



These items are subject to discount group 1.

LOOP®-S Recessed spotlight housing, without LED module

All Brumberg MR16 LED modules can be used for the LOOP installation unit. The installation depth of the luminaire depends on the LED module used (here: 5 mm, plus the height of the LED module). The LED module is not included in the scope of supply of the installation unit.

Lamp: for LED, power: max. 14 W, material: nylon / magnesium hydroxide / fibreglass

You can find the corresponding LED modules on page 194. An overview of suitable power supply units can be found on page 202.

| Article no. | Colour | Price in € |
|-------------|----------------|------------|
| 27065170 | textured white | 31.00 |
| 27065180 | textured black | 31.00 |



These items are subject to discount group 1.

MEER LOOP!

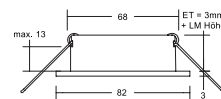
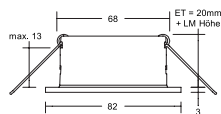

LOOP® deep Recessed spotlight housing, without LED module

NEW

All Brumberg MR16 LED modules can be used for the LOOP installation unit. The installation depth of the luminaire depends on the LED module used (here: 20 mm, plus the height of the LED module). The LED module is not included in the scope of supply of the installation unit.

Lamp: for LED, power: max. 14 W,
material: nylon / magnesium hydroxide / fibreglass

You can find the corresponding LED modules on page 194.
An overview of suitable power supply units can be found on page 202.

| Article no. | Colour | Price in € |
|-------------|--------------------|------------|
| 27068170 | NEW textured white | 28.80 |
| 27068180 | NEW textured black | 28.80 |



These items are subject to discount group 1.

LOOP® IP Recessed downlight housing, IP44, without LED module

NEW

All Brumberg MR16 LED modules with an output of up to 10 W can be used for the LOOP installation unit. The installation depth of the luminaire depends on the LED module used (here: 3 mm, plus the height of the LED module). The LED module is not included in the scope of supply of the installation unit.

Lamp: for LED, power: max. 10 W,
material: nylon / magnesium hydroxide / fibreglass / glass

You can find the corresponding LED modules on page 194.
An overview of suitable power supply units can be found on page 202.

| Article no. | Colour | Price in € |
|-------------|--------------------|------------|
| 27064170 | NEW textured white | 39.90 |
| 27064180 | NEW textured black | 39.90 |



IP44 when installed in closed ceilings.
These items are subject to discount group 1.

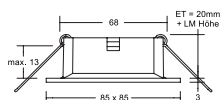
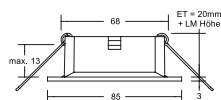

LOOP® smooth-R Recessed downlight housing, without LED module

NEW

All Brumberg MR16 LED modules can be used for the LOOP installation unit. The installation depth of the luminaire depends on the LED module used (here: 20 mm, plus the height of the LED module). The LED module is not included in the scope of supply of the installation unit.

Lamp: for LED, power: max. 14 W,
material: nylon / magnesium hydroxide / fibreglass

You can find the corresponding LED modules on page 194.
An overview of suitable power supply units can be found on page 202.

| Article no. | Colour | Price in € |
|-------------|--------------------|------------|
| 27066170 | NEW textured white | 27.90 |
| 27066180 | NEW textured black | 27.90 |



These items are subject to discount group 1.

LOOP® smooth-S Recessed downlight housing, without LED module

NEW

All Brumberg MR16 LED modules can be used for the LOOP installation unit. The installation depth of the luminaire depends on the LED module used (here: 20 mm, plus the height of the LED module). The LED module is not included in the scope of supply of the installation unit.

Lamp: for LED, power: max. 14 W,
material: nylon / magnesium hydroxide / fibreglass

You can find the corresponding LED modules on page 194.
An overview of suitable power supply units can be found on page 202.

| Article no. | Colour | Price in € |
|-------------|--------------------|------------|
| 27067170 | NEW textured white | 28.90 |
| 27067180 | NEW textured black | 28.90 |



These items are subject to discount group 1.



THIN

LOOP[®]

Light Of Ocean Plastic.



COMING
SOON

THINK BIG

Sustainable UGR<19 downlight series
made of Ocean Plastic for your project.

re:think re:spect re:cycle re:use

ABACO.

LED recessed spotlight.

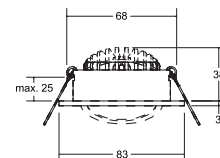
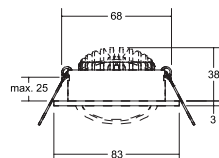

ABACO-R LED recessed spotlight set, trailing-edge phase dimmable, IP44

NEW

Set includes round converter for 230 V mains voltage, trailing-edge phase dimmable, converter dimensions: D 65 x H 26 mm

Lamp: LED, colour rendering: CRI 82, power: 8 W, beam angle: 36°, material: aluminium / PMMA, includes 3-pole connection box suitable for through-wiring

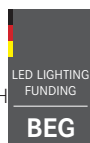

| Article no. | Colour | Lumin. flux | Colour temp. | Price in € |
|-------------|---------------------------|-------------|--------------|------------|
| 39413153 | NEW matt nickel | 1,010 lm | 3,000 K | 84.90 |
| 39413173 | NEW textured white | 1,010 lm | 3,000 K | 79.90 |
| 39413183 | NEW textured black | 1,010 lm | 3,000 K | 79.90 |

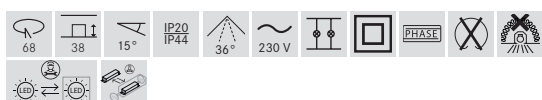

IP44 when installed in closed ceilings.
These items are subject to discount group 1.

dim²warm

ABACO-R LED recessed spotlight set, trailing-edge phase dimmable, dim2warm, IP44

NEW

If the light is dimmed, the colour temperature is reduced.
Set includes round converter for 230 V mains voltage, trailing-edge phase dimmable, converter dimensions: D 65 x H 26 mm

Lamp: LED, colour rendering: CRI 82, power: 8 W, beam angle: 36°, material: aluminium / PMMA, includes 3-pole connection box suitable for through-wiring

| Article no. | Colour | Lumin. flux | Colour temp. | Price in € |
|-------------|---------------------------|-------------|-------------------|------------|
| 39413153DW | NEW matt nickel | 530 lm | 3,000 K - 1,800 K | 94.90 |
| 39413173DW | NEW textured white | 530 lm | 3,000 K - 1,800 K | 89.90 |
| 39413183DW | NEW textured black | 530 lm | 3,000 K - 1,800 K | 89.90 |

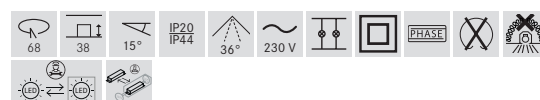

IP44 when installed in closed ceilings.
These items are subject to discount group 1.

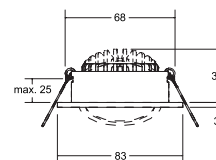
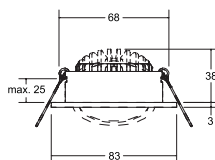

ABACO-R LED recessed spotlight set, DALI dimmable, IP44

NEW

Set includes round converter for 230 V mains voltage, DALI-2 dimmable, converter dimensions: D 57 x H 25 mm

Lamp: LED, colour rendering: CRI 82, power: 8 W, beam angle: 36°, material: aluminium / PMMA, includes 5-pole connection box suitable for through-wiring



| Article no. | Colour | Lumin. flux | Colour temp. | Price in € |
|-------------|---------------------------|-------------|--------------|------------|
| 41413153 | NEW matt nickel | 1,010 lm | 3,000 K | 124.00 |
| 41413173 | NEW textured white | 1,010 lm | 3,000 K | 119.00 |
| 41413183 | NEW textured black | 1,010 lm | 3,000 K | 119.00 |

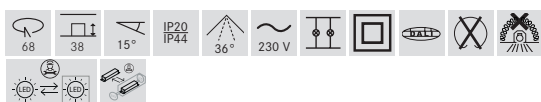

IP44 when installed in closed ceilings.
These items are subject to discount group 1.

dim²warm

ABACO-R LED recessed spotlight set, DALI dimmable, dim2warm, IP44

NEW

Set includes round converter for 230 V mains voltage, DALI-2 dimmable, converter dimensions: D 57 x H 25 mm

Lamp: LED, colour rendering: CRI 82, power: 8 W, beam angle: 36°, material: aluminium / PMMA, includes 5-pole connection box suitable for through-wiring

| Article no. | Colour | Lumin. flux | Colour temp. | Price in € |
|-------------|---------------------------|-------------|-------------------|------------|
| 41413153DW | NEW matt nickel | 530 lm | 3,000 K - 1,800 K | 134.00 |
| 41413173DW | NEW textured white | 530 lm | 3,000 K - 1,800 K | 129.00 |
| 41413183DW | NEW textured black | 530 lm | 3,000 K - 1,800 K | 129.00 |

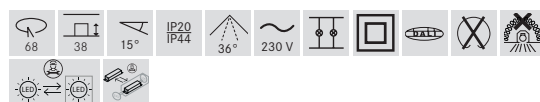

IP44 when installed in closed ceilings.
These items are subject to discount group 1.

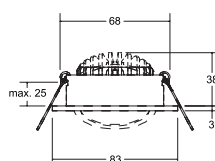

tunable
WHITE

ABACO-R LED recessed spotlight set, DALI dimmable, TunableWhite, IP44

NEW

Set includes converter for 230 V mains voltage, DALI-2 dimmable, converter dimensions: L 178 x W 46 x H 22 mm

Lamp: LED, colour rendering: CRI 82, power: 6 W, beam angle: 36°, material: aluminium / PMMA, includes 5-pole connection box suitable for through-wiring



| Article no. | Colour | Lumin. flux | Colour temp. | Price in € |
|-------------|---------------------------|-------------|-------------------|------------|
| 41413154TW | NEW matt nickel | 750 lm | 2,700 K - 6,500 K | 154.90 |
| 41413174TW | NEW textured white | 750 lm | 2,700 K - 6,500 K | 149.90 |
| 41413184TW | NEW textured black | 750 lm | 2,700 K - 6,500 K | 149.90 |

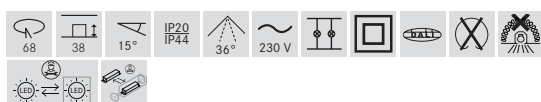

IP44 when installed in closed ceilings.
These items are subject to discount group 1.

ABACO. LED recessed spotlight.

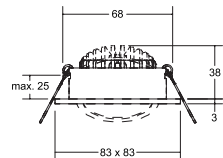
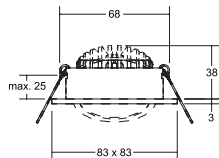

ABACO-S LED recessed spotlight set, trailing-edge phase dimmable, IP44

NEW

Set includes round converter for 230 V mains supply, trailing-edge phase dimmable, converter dimensions: D 65 x H 26 mm

Lamp: LED, colour rendering: CRI 82, power: 8 W, beam angle: 36°, material: aluminium / PMMA, includes 3-pole connection box suitable for through-wiring



| Article no. | Colour | Lumin. flux | Colour temp. | Price in € |
|-------------|---------------------------|-------------|--------------|------------|
| 39415153 | NEW matt nickel | 1,010 lm | 3,000 K | 89.90 |
| 39415173 | NEW textured white | 1,010 lm | 3,000 K | 84.90 |
| 39415183 | NEW textured black | 1,010 lm | 3,000 K | 84.90 |

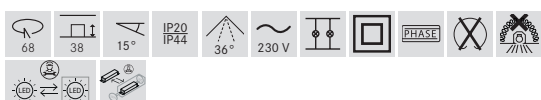

IP44 when installed in closed ceilings.
These items are subject to discount group 1.

ABACO-S LED recessed spotlight set, trailing-edge phase dimmable, dim2warm, IP44

NEW

If the light is dimmed, the colour temperature is reduced.
Set includes round converter for 230 V mains voltage, trailing-edge phase dimmable, converter dimensions: D 65 x H 26 mm

Lamp: LED, colour rendering: CRI 82, power: 8 W, beam angle: 36°, material: aluminium / PMMA, includes 3-pole connection box suitable for through-wiring

| Article no. | Lumin. flux | Colour temp. | Price in € |
|--------------------------------------|-------------|-------------------|------------|
| 39415153DW NEW matt nickel | 530 lm | 3,000 K - 1,800 K | 99.90 |
| 39415173DW NEW textured white | 530 lm | 3,000 K - 1,800 K | 94.90 |
| 39415183DW NEW textured black | 530 lm | 3,000 K - 1,800 K | 94.90 |

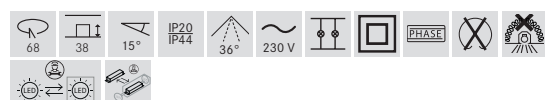

IP44 when installed in closed ceilings.
These items are subject to discount group 1.

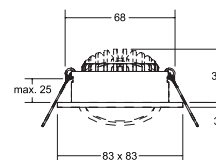
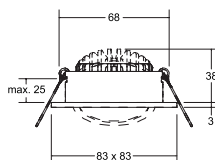

ABACO-S LED recessed spotlight set, DALI dimmable, IP44

NEW

Set includes round converter for 230 V mains voltage, DALI-2 dimmable, converter dimensions: D 57 x H 25 mm

Lamp: LED, colour rendering: CRI 82, power: 8 W, beam angle: 36°, material: aluminium / PMMA, includes 5-pole connection box suitable for through-wiring



| Article no. | Colour | Lumin. flux | Colour temp. | Price in € |
|-------------|---------------------------|-------------|--------------|------------|
| 41415153 | NEW matt nickel | 1,010 lm | 3,000 K | 129.90 |
| 41415173 | NEW textured white | 1,010 lm | 3,000 K | 124.90 |
| 41415183 | NEW textured black | 1,010 lm | 3,000 K | 124.90 |

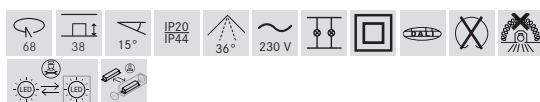

IP44 when installed in closed ceilings. These items are subject to discount group 1.

dim²warm

ABACO-S LED recessed spotlight set, DALI dimmable, dim2warm, IP44

NEW

Set includes round converter for 230 V mains voltage, DALI-2 dimmable, converter dimensions: D 57 x H 25 mm

Lamp: LED, colour rendering: CRI 82, power: 8 W, beam angle: 36°, material: aluminium / PMMA, includes 5-pole connection box suitable for through-wiring

| Article no. | Colour | Lumin. flux | Colour temp. | Price in € |
|-------------|---------------------------|-------------|-------------------|------------|
| 41415153DW | NEW matt nickel | 530 lm | 3,000 K - 1,800 K | 139.90 |
| 41415173DW | NEW textured white | 530 lm | 3,000 K - 1,800 K | 134.90 |
| 41415183DW | NEW textured black | 530 lm | 3,000 K - 1,800 K | 134.90 |

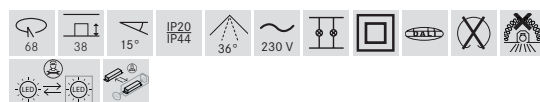

IP44 when installed in closed ceilings. These items are subject to discount group 1.

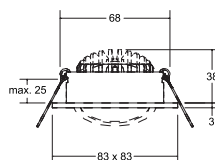

ABACO-S LED recessed spotlight set, DALI dimmable, TunableWhite, IP44

NEW

Set includes converter for 230 V mains voltage, DALI-2 dimmable, converter dimensions: L 178 x W 46 x H 22 mm

Lamp: LED, colour rendering: CRI 82, power: 6 W, beam angle: 36°, material: aluminium / PMMA, includes 5-pole connection box suitable for through-wiring



| Article no. | Colour | Lumin. flux | Colour temp. | Price in € |
|-------------|---------------------------|-------------|-------------------|------------|
| 41415154TW | NEW matt nickel | 750 lm | 2,700 K - 6,500 K | 159.90 |
| 41415174TW | NEW textured white | 750 lm | 2,700 K - 6,500 K | 154.90 |
| 41415184TW | NEW textured black | 750 lm | 2,700 K - 6,500 K | 154.90 |

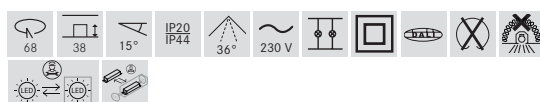

IP44 when installed in closed ceilings. These items are subject to discount group 1.

The alternative to LED retrofit. Simply reliable.



Planning.

A set for reliability. The individual components are electrically harmonised and ensure stable operating times. The respective specification is omitted.



Order.

One article number for three components. Luminaire, LED module and converter can be ordered with one article number. "Search times" are reduced as only one product is picked. Ideal for warehouse management: the availability of all components is guaranteed from the outset.



Installation.

Accelerated installation and faster commissioning. Thanks to the assembly, the sets are much easier to install – whether for new builds, retrofitting or refurbishment. Confusion can be ruled out in advance.



BB-Sets.

Complete set including light, LED module and converter.

With sophisticated, reliable lighting solutions that connect people and spaces, we create lighting situations in which people feel comfortable. Whether for new builds or renovations: well thought-out lighting design takes time. It is a good thing if the workload can be reduced. With the Brumberg LED sets, we have combined three products in one article number. This saves time when putting the lights together and simplifies installation. Our set includes the light, the LED module and the matching converter.

Product advantages:

- 5-year Brumberg light guarantee.
- A total of over 300 different sets in different surfaces.
- Various dimming technologies: from switchable and trailing-edge phase to DALI.
- Quick installation in existing ceiling cut-outs.
- Simplified planning with pre-selected ballasts.
- Round and square sets in numerous housing colours for many different lighting requirements.
- All DALI sets are equipped with converters without “glow in the dark” effect
- Available in degrees of protection IP20 and IP65.
- IP65: with cover cap for mechanical protection and maintaining the required installation depth.

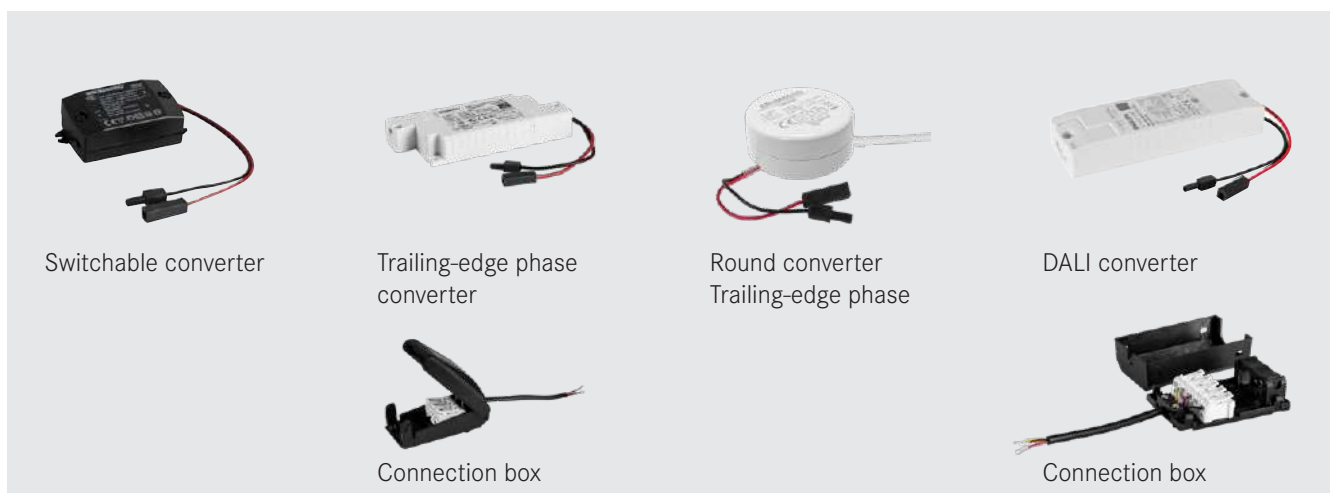

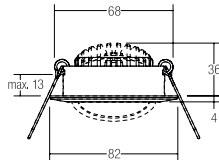

Switchable converter

BB03 LED recessed spotlight set, switchable

Set includes converter for 230 V mains voltage, switchable, converter dimensions: L 68 x W 35 x H 21 mm

Lamp: LED, colour rendering: CRI > 80, power: 6 W, system efficiency: 105 lm / W, beam angle: 38°, material: aluminium / polycarbonate

Service life:

L80/B20, 50,000 hrs. (ta: +25 °C)

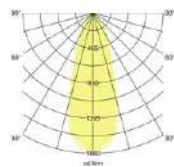

| Article no. | Colour | Lumin. flux | Colour temp. | Price in € |
|-------------|----------------|-------------|--------------|------------|
| 38363023 | glossy chrome | 630 lm | 3,000 K | 55.00 |
| 38363073 | glossy white | 630 lm | 3,000 K | 51.20 |
| 38363173 | textured white | 630 lm | 3,000 K | 51.20 |
| 38363153 | matt nickel | 630 lm | 3,000 K | 55.00 |
| 38363183 | textured black | 630 lm | 3,000 K | 51.20 |



These items are subject to discount group 1.



Trailing-edge phase converter

BB03 LED recessed spotlight set, trailing-edge phase dimmable

Set includes converter for 230 V mains voltage, trailing-edge phase dimmable, converter dimensions: L 110 x W 50 x H 19 mm

Lamp: LED, colour rendering: CRI > 80, power: 6 W, system efficiency: 105 lm / W, beam angle: 38°, material: aluminium / polycarbonate

Service life:

L80/B20, 50,000 hrs. (ta: +25 °C)

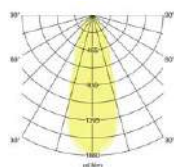

| Article no. | Colour | Lumin. flux | Colour temp. | Price in € |
|-------------|----------------|-------------|--------------|------------|
| 39363023 | glossy chrome | 630 lm | 3,000 K | 57.50 |
| 39363073 | glossy white | 630 lm | 3,000 K | 53.70 |
| 39363173 | textured white | 630 lm | 3,000 K | 53.70 |
| 39363153 | matt nickel | 630 lm | 3,000 K | 57.50 |
| 39363183 | textured black | 630 lm | 3,000 K | 53.70 |



These items are subject to discount group 1.



Switchable converter



Connection box

BB03 LED recessed spotlight set, switchable, with connection box

Set includes converter for 230 V mains voltage, switchable, converter dimensions: L 68 x W 35 x H 21 mm

Lamp: LED, colour rendering: CRI > 80, power: 6 W, system efficiency: 105 lm / W, beam angle: 38°, material: aluminium / polycarbonate, includes 3-pole connection box

Service life:

L80/B20, 50,000 hrs. (ta: +25 °C)

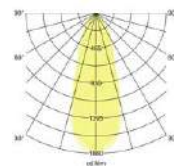

| Article no. | Colour | Lumin. flux | Colour temp. | Price in € |
|-------------|----------------|-------------|--------------|------------|
| 38463023 | glossy chrome | 630 lm | 3,000 K | 63.40 |
| 38463073 | glossy white | 630 lm | 3,000 K | 59.30 |
| 38463173 | textured white | 630 lm | 3,000 K | 59.30 |
| 38463153 | matt nickel | 630 lm | 3,000 K | 63.40 |
| 38463183 | textured black | 630 lm | 3,000 K | 59.60 |



These items are subject to discount group 1.



Trailing-edge phase converter



Connection box

BB03 LED recessed spotlight set, trailing-edge phase dimmable, with connection box

Set includes converter for 230 V mains voltage, trailing-edge phase dimmable, converter dimensions: L 110 x W 50 x H 19 mm

Lamp: LED, colour rendering: CRI > 80, power: 6 W, system efficiency: 105 lm / W, beam angle: 38°, material: aluminium / polycarbonate, includes 3-pole connection box

Service life:

L80/B20, 50,000 hrs. (ta: +25 °C)

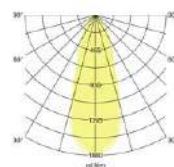

| Article no. | Colour | Lumin. flux | Colour temp. | Price in € |
|-------------|----------------|-------------|--------------|------------|
| 39463023 | glossy chrome | 630 lm | 3,000 K | 65.90 |
| 39463073 | glossy white | 630 lm | 3,000 K | 61.90 |
| 39463173 | textured white | 630 lm | 3,000 K | 61.90 |
| 39463153 | matt nickel | 630 lm | 3,000 K | 65.90 |
| 39463183 | textured black | 630 lm | 3,000 K | 61.90 |



These items are subject to discount group 1.



Round trailing-edge phase converter

BB03 LED recessed spotlight set, trailing-edge phase dimmable

Set includes round converter for 230 V mains voltage, trailing-edge phase dimmable, converter dimensions: D 51 x H 24 mm

Lamp: LED, colour rendering: CRI > 80, power: 6 W, system efficiency: 105 lm / W, beam angle: 38°, material: aluminium / polycarbonate

Service life:

L80/B20, 50,000 hrs. (ta: +25 °C)

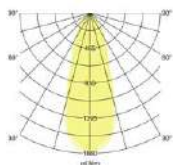

| Article no. | Colour | Lumin. flux | Colour temp. | Price in € |
|-------------|----------------|-------------|--------------|------------|
| 40363023 | glossy chrome | 630 lm | 3,000 K | 71.30 |
| 40363073 | glossy white | 630 lm | 3,000 K | 67.50 |
| 40363173 | textured white | 630 lm | 3,000 K | 67.50 |
| 40363153 | matt nickel | 630 lm | 3,000 K | 71.30 |
| 40363183 | textured black | 630 lm | 3,000 K | 67.50 |



These items are subject to discount group 1.



DALI converter



Connection box

BB03 LED recessed spotlight set, DALI dimmable, with connection box

Set includes converter for 230 V mains voltage, DALI-2 dimmable, converter dimensions: L 130 x W 42 x H 22 mm

Lamp: LED, colour rendering: CRI > 80, power: 6 W, system efficiency: 105 lm / W, beam angle: 38°, material: aluminium / polycarbonate, includes 5-pole connection box

Service life:

L80/B20, 50,000 hrs. (ta: +25 °C)

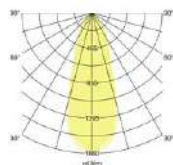

| Article no. | Colour | Lumin. flux | Colour temp. | Price in € |
|-------------|----------------|-------------|--------------|------------|
| 41463023 | glossy chrome | 630 lm | 3,000 K | 105.90 |
| 41463073 | glossy white | 630 lm | 3,000 K | 102.90 |
| 41463173 | textured white | 630 lm | 3,000 K | 102.90 |
| 41463153 | matt nickel | 630 lm | 3,000 K | 105.90 |
| 41463183 | textured black | 630 lm | 3,000 K | 102.90 |

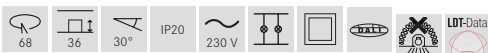

These items are subject to discount group 1.



Round trailing-edge phase converter



Connection box

BB03 LED recessed spotlight set, trailing-edge phase dimmable, with connection box

Set includes round converter for 230 V mains voltage, trailing-edge phase dimmable, converter dimensions: D 51 x H 24 mm

Lamp: LED, colour rendering: CRI > 80, power: 6 W, system efficiency: 105 lm / W, beam angle: 38°, material: aluminium / polycarbonate includes 3-pole connection box

Service life:

L80/B20, 50,000 hrs. (ta: +25 °C)

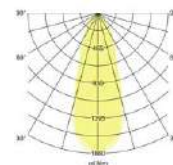

| Article no. | Colour | Lumin. flux | Colour temp. | Price in € |
|-------------|----------------|-------------|--------------|------------|
| 40463023 | glossy chrome | 630 lm | 3,000 K | 79.70 |
| 40463073 | glossy white | 630 lm | 3,000 K | 75.90 |
| 40463173 | textured white | 630 lm | 3,000 K | 75.90 |
| 40463153 | matt nickel | 630 lm | 3,000 K | 79.70 |
| 40463183 | textured black | 630 lm | 3,000 K | 75.90 |



These items are subject to discount group 1.



Leaf spring set for BB sets BB03 / BB05

The leaf spring set includes 2 leaf springs for on-site fitting (replacement of the standard leg spring) of BB sets 03 and 05.

| Article no. | Price in € |
|-------------|------------|
| 532700 | 2.70 |

This item is subject to discount group 1.

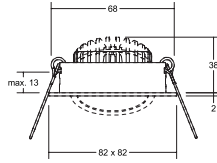

Switchable converter

BB05 LED recessed spotlight set, switchable

Set includes converter for 230 V mains voltage, switchable, converter dimensions: L 68 x W 35 x H 21 mm

Lamp: LED, colour rendering: CRI > 80, power: 6 W, system efficiency: 105 lm / W, beam angle: 38°, material: aluminium / polycarbonate

Service life:

L80/B20, 50,000 hrs. (ta: +25 °C)

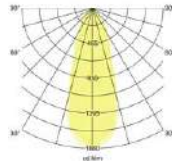

| Article no. | Colour | Lumin. flux | Colour temp. | Price in € |
|---------------------|----------------|-------------|--------------|------------|
| 38365023 | glossy chrome | 630 lm | 3,000 K | 57.50 |
| 38365073 | glossy white | 630 lm | 3,000 K | 52.50 |
| 38365173 NEW | textured white | 630 lm | 3,000 K | 52.50 |
| 38365153 | matt nickel | 630 lm | 3,000 K | 57.50 |
| 38365183 NEW | textured black | 630 lm | 3,000 K | 52.50 |



These items are subject to discount group 1.



Trailing-edge phase converter

BB05 LED recessed spotlight set, trailing-edge phase dimmable

Set includes converter for 230 V mains voltage, trailing-edge phase dimmable, system efficiency: 105 lm / W, converter dimensions: L 110 x W 50 x H 19 mm

Lamp: LED, colour rendering: CRI > 80, power: 6 W, system efficiency: 105 lm / W, beam angle: 38°, material: aluminium / polycarbonate

Service life:

L80/B20, 50,000 hrs. (ta: +25 °C)

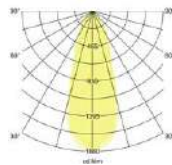

| Article no. | Colour | Lumin. flux | Colour temp. | Price in € |
|-------------|----------------|-------------|--------------|------------|
| 39365023 | glossy chrome | 630 lm | 3,000 K | 60.00 |
| 39365073 | glossy white | 630 lm | 3,000 K | 55.00 |
| 39365173 | textured white | 630 lm | 3,000 K | 55.00 |
| 39365153 | matt nickel | 630 lm | 3,000 K | 60.00 |
| 39365183 | textured black | 630 lm | 3,000 K | 55.00 |



These items are subject to discount group 1.



Switchable converter



Connection box

BB05 LED recessed spotlight set, switchable, with connection box

Set includes converter for 230 V mains voltage, switchable, converter dimensions: L 68 x W 35 x H 21 mm

Lamp: LED, colour rendering: CRI > 80, power: 6 W, system efficiency: 105 lm / W, beam angle: 38°, material: aluminium / polycarbonate includes 3-pole connection box

Service life:

L80/B20, 50,000 hrs. (ta: +25 °C)

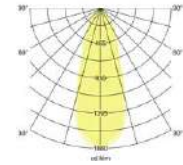

| Article no. | Colour | Lumin. flux | Colour temp. | Price in € |
|-------------|----------------|-------------|--------------|------------|
| 38465023 | glossy chrome | 630 lm | 3,000 K | 65.90 |
| 38465073 | glossy white | 630 lm | 3,000 K | 60.90 |
| 38465173 | textured white | 630 lm | 3,000 K | 60.90 |
| 38465153 | matt nickel | 630 lm | 3,000 K | 65.90 |
| 38465183 | textured black | 630 lm | 3,000 K | 60.90 |



These items are subject to discount group 1.



Trailing-edge phase converter



Connection box

BB05 LED recessed spotlight set, trailing-edge phase dimmable, with connection box

Set includes converter for 230 V mains voltage, trailing-edge phase dimmable, converter dimensions: L 110 x W 50 x H 19 mm

Lamp: LED, colour rendering: CRI > 80, power: 6 W, system efficiency: 105 lm / W, beam angle: 38°, material: aluminium / polycarbonate, includes 3-pole connection box

Service life:

L80/B20, 50,000 hrs. (ta: +25 °C)

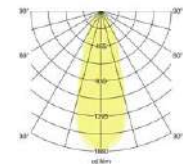

| Article no. | Colour | Lumin. flux | Colour temp. | Price in € |
|-------------|----------------|-------------|--------------|------------|
| 39465023 | glossy chrome | 630 lm | 3,000 K | 67.90 |
| 39465073 | glossy white | 630 lm | 3,000 K | 62.90 |
| 39465173 | textured white | 630 lm | 3,000 K | 62.90 |
| 39465153 | matt nickel | 630 lm | 3,000 K | 67.90 |
| 39465183 | textured black | 630 lm | 3,000 K | 62.90 |



These items are subject to discount group 1.



Round trailing-edge phase converter

BB05 LED recessed spotlight set, trailing-edge phase dimmable (round converter)

Set includes round converter for 230 V mains voltage, trailing-edge phase dimmable, converter dimensions: D 51 x H 24 mm

Lamp: LED, colour rendering: CRI > 80, power: 6 W, system efficiency: 105 lm / W, beam angle: 38°, material: aluminium / polycarbonate

Service life:

L80/B20, 50,000 hrs. (ta: +25 °C)

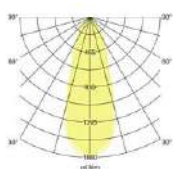

| Article no. | Colour | Lumin. flux | Colour temp. | Price in € |
|-------------|----------------|-------------|--------------|------------|
| 40365023 | glossy chrome | 630 lm | 3,000 K | 73.70 |
| 40365073 | glossy white | 630 lm | 3,000 K | 68.70 |
| 40365173 | textured white | 630 lm | 3,000 K | 68.70 |
| 40365153 | matt nickel | 630 lm | 3,000 K | 73.70 |
| 40365183 | textured black | 630 lm | 3,000 K | 68.70 |



These items are subject to discount group 1.



DALI converter



Connection box

BB05 LED recessed spotlight set, DALI dimmable, with connection box

Set includes converter for 230 V mains voltage, DALI-2 dimmable, system efficiency: 105 lm / W, converter dimensions: L 130 x W 42 x H 22 mm

Lamp: LED, colour rendering: CRI > 80, power: 6 W, system efficiency: 105 lm / W, beam angle: 38°, material: aluminium / polycarbonate, includes 5-pole connection box

Service life:

L80/B20, 50,000 hrs. (ta: +25 °C)

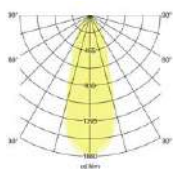

| Article no. | Colour | Lumin. flux | Colour temp. | Price in € |
|-------------|----------------|-------------|--------------|------------|
| 41465023 | glossy chrome | 630 lm | 3,000 K | 108.90 |
| 41465073 | glossy white | 630 lm | 3,000 K | 103.90 |
| 41465173 | textured white | 630 lm | 3,000 K | 103.90 |
| 41465153 | matt nickel | 630 lm | 3,000 K | 108.90 |
| 41465183 | textured black | 630 lm | 3,000 K | 103.90 |



These items are subject to discount group 1.



Round trailing-edge phase converter



Connection box

BB05 LED recessed spotlight set, trailing-edge phase dimmable, with connection box

Set includes round converter for 230 V mains voltage, trailing-edge phase dimmable, converter dimensions: D 51 x H 24 mm

Lamp: LED, colour rendering: CRI > 80, power: 6 W, system efficiency: 105 lm / W, beam angle: 38°, material: aluminium / polycarbonate includes 3-pole connection box

Service life:

L80/B20, 50,000 hrs. (ta: +25 °C)

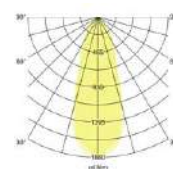

| Article no. | Colour | Lumin. flux | Colour temp. | Price in € |
|-------------|----------------|-------------|--------------|------------|
| 40465023 | glossy chrome | 630 lm | 3,000 K | 82.10 |
| 40465073 | glossy white | 630 lm | 3,000 K | 77.10 |
| 40465173 | textured white | 630 lm | 3,000 K | 77.10 |
| 40465153 | matt nickel | 630 lm | 3,000 K | 82.10 |
| 40465183 | textured black | 630 lm | 3,000 K | 77.10 |



These items are subject to discount group 1.



Leaf spring set for BB sets BB03 / BB05

The leaf spring set includes 2 leaf springs for on-site fitting (replacement of the standard leg spring) of BB sets 03 and 05.

| Article no. | Price in € |
|-------------|------------|
| 532700 | 2.70 |

This item is subject to discount group 1.



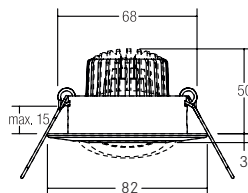

dim²warm

BB18 LED recessed spotlight set, dim2warm, trailing-edge phase dimmable, with connection box

If the light is dimmed, the colour temperature is reduced. Set includes converter for 230 V mains voltage, trailing-edge phase dimmable, converter dimensions: L 110 x W 50 x H 19 mm, lamp: LED, colour rendering: CRI > 80, power: 6 W, system efficiency: 72 lm / W, beam angle: 38°, material: aluminium / glass / plastic, includes 3-pole connection box

| Article no. | Colour | Lumin. flux | Colour temp. | Price in € |
|-------------|----------------|-------------|-------------------|------------|
| 39483023 | glossy chrome | 430 lm | 3,000 K - 1,800 K | 95.50 |
| 39483073 | matt white | 430 lm | 3,000 K - 1,800 K | 94.20 |
| 39483083 | matt black | 430 lm | 3,000 K - 1,800 K | 94.20 |
| 39483173 | textured white | 430 lm | 3,000 K - 1,800 K | 94.20 |
| 39483253 | matt aluminium | 430 lm | 3,000 K - 1,800 K | 94.20 |
| 39483633 | matt champagne | 430 lm | 3,000 K - 1,800 K | 99.90 |
| 39483643 | matt titanium | 430 lm | 3,000 K - 1,800 K | 99.90 |



These items are subject to discount group 1.

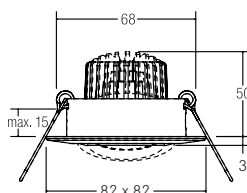

dim²warm

BB19 LED recessed spotlight set, dim2warm, trailing-edge phase dimmable, with connection box

If the light is dimmed, the colour temperature is reduced. Set includes converter for 230 V mains voltage, trailing-edge phase dimmable, converter dimensions: L 110 x W 50 x H 19 mm, lamp: LED, colour rendering: CRI > 80, power: 6 W, system efficiency: 72 lm / W, beam angle: 38°, material: aluminium / glass / plastic, includes 3-pole connection box

| Article no. | Colour | Lumin. flux | Colour temp. | Price in € |
|-------------|----------------|-------------|-------------------|------------|
| 39485023 | glossy chrome | 430 lm | 3,000 K - 1,800 K | 98.60 |
| 39485073 | matt white | 430 lm | 3,000 K - 1,800 K | 97.30 |
| 39485083 | matt black | 430 lm | 3,000 K - 1,800 K | 97.30 |
| 39485173 | textured white | 430 lm | 3,000 K - 1,800 K | 97.30 |
| 39485253 | matt aluminium | 430 lm | 3,000 K - 1,800 K | 97.30 |
| 39485633 | matt champagne | 430 lm | 3,000 K - 1,800 K | 103.00 |
| 39485643 | matt titanium | 430 lm | 3,000 K - 1,800 K | 103.00 |



These items are subject to discount group 1.



DIP switch for
setting the colour temperature
from 2,700 K to 4,000 K.

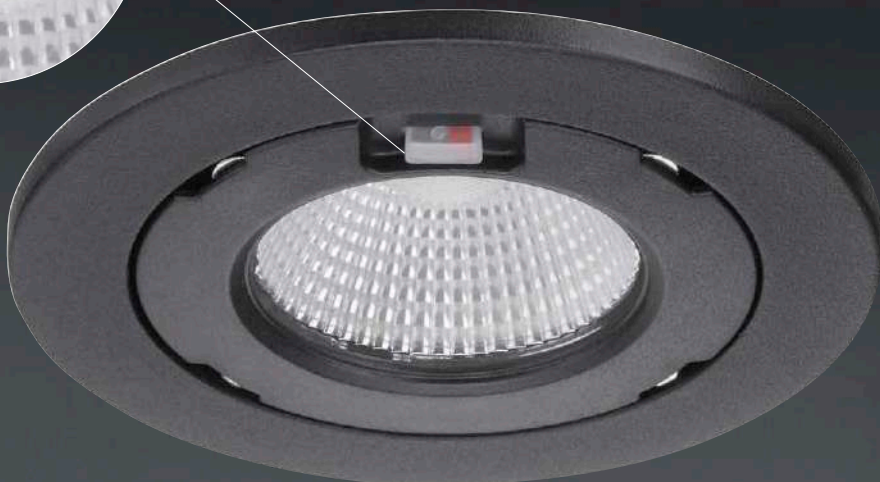

CHOOOSE.

LED recessed downlight sets.

Always the right light.

The Choosee LED recessed ceiling downlight enables flexible adjustment of the colour temperature when installed. It can be switched by means of a magnetically attached cover and a DIP switch underneath.

The Choosee downlight series, which includes round and square versions, is extremely versatile thanks to its dimmable converter (trailing-edge phase) and a ceiling cut-out of 68 mm and can be used for a wide variety of requirements.



CHOOOSE LED recessed downlight set, with adjustable colour temperature, trailing-edge phase dimmable, IP44

Lamp: LED, colour rendering: CRI > 80, beam angle: 40°, power: 4.5 W, material: aluminium / steel / plastic, incl. converter for connection to 230 V mains voltage, trailing-edge phase dimmable

Service life:

L70/B50, > 50,000 hrs. (ta: +25 °C)

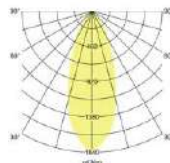

| Article no. | Colour | Lumin. flux | Colour temp. | Price in € |
|-------------|-------------|-------------|-----------------------------|------------|
| 39253073 | white matt | 510 lm | 2,700 K / 3,000 K / 4,000 K | 72.70 |
| 39253083 | black matt | 510 lm | 2,700 K / 3,000 K / 4,000 K | 72.70 |
| 39253153 | matt nickel | 510 lm | 2,700 K / 3,000 K / 4,000 K | 74.20 |



Luminous flux specification for light colour 3,000 K. Degree of protection IP44 when installed in closed ceilings. These items are subject to discount group 1.

CHOOOSE LED recessed downlight set, with adjustable colour temperature, trailing-edge phase dimmable, IP44

Lamp: LED, colour rendering: CRI > 80, beam angle: 40°, power: 4.5 W, material: aluminium / steel / plastic, incl. converter for connection to 230 V mains voltage, trailing-edge phase dimmable

Service life:

L70/B50, > 50,000 hrs. (ta: +25 °C)

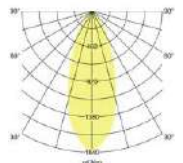

| Article no. | Colour | Lumin. flux | Colour temp. | Price in € |
|-------------|-------------|-------------|-----------------------------|------------|
| 39255073 | white matt | 510 lm | 2,700 K / 3,000 K / 4,000 K | 74.20 |
| 39255083 | black matt | 510 lm | 2,700 K / 3,000 K / 4,000 K | 74.20 |
| 39255153 | matt nickel | 510 lm | 2,700 K / 3,000 K / 4,000 K | 75.70 |



Luminous flux specification for light colour 3,000 K. Degree of protection IP44 when installed in closed ceilings. These items are subject to discount group 1.

OLENI.

LED recessed spotlight.

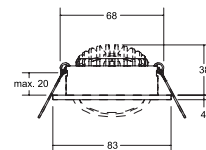
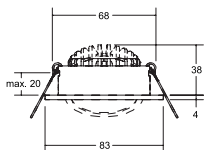

dim **2** warm

OLENI LED recessed spotlight, integrated converter trailing-edge phase dimmable, with connection box

NEW

Lamp: LED, colour rendering: CRI > 80, power: 6 W, beam angle: 38°, material: aluminium / polycarbonate, includes 3-pole connection box suitable for through-wiring

| Article no. | Colour | Lumin. flux | Colour temp. | Price in € |
|-------------|---------------------------|-------------|--------------|------------|
| 12646153 | NEW matt nickel | 600 lm | 3,000 K | 49.20 |
| 12646173 | NEW textured white | 600 lm | 3,000 K | 45.70 |
| 12646183 | NEW textured black | 600 lm | 3,000 K | 45.70 |

OLENI LED recessed spotlight, integrated converter trailing-edge phase dimmable, dim2warm, with connection box

NEW

Lamp: LED, colour rendering: CRI > 80, power: 6 W, beam angle: 38°, material: aluminium / polycarbonate, includes 3-pole connection box suitable for through-wiring

| Article no. | Colour | Lumin. flux | Colour temp. | Price in € |
|-------------|---------------------------|-------------|-------------------|------------|
| 12646153DW | NEW matt nickel | 410 lm | 3,000 K - 1,800 K | 56.20 |
| 12646173DW | NEW textured white | 410 lm | 3,000 K - 1,800 K | 52.70 |
| 12646183DW | NEW textured black | 410 lm | 3,000 K - 1,800 K | 52.70 |



These items are subject to discount group 1.



These items are subject to discount group 1.



OBIRA.

LED recessed downlights.

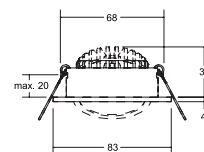
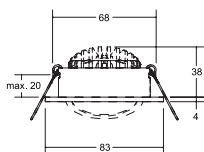

OBIRA LED recessed downlight, integrated converter trailing-edge phase dimmable, IP65, with connection box

NEW

Lamp: LED, colour rendering: CRI > 80, power: 6 W, beam angle: 38°, material: aluminium / polycarbonate, includes 3-pole connection box suitable for through-wiring

| Article no. | Colour | Lumin. flux | Colour temp. | Price in € |
|-------------|---------------------------|-------------|--------------|------------|
| 12647153 | NEW matt nickel | 600 lm | 3,000 K | 47.50 |
| 12647173 | NEW textured white | 600 lm | 3,000 K | 44.10 |
| 12647183 | NEW textured black | 600 lm | 3,000 K | 44.10 |

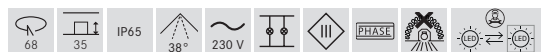

IP65 when installed in closed ceilings

These items are subject to discount group 1.

dim²warm

OBIRA LED recessed downlight, integrated converter trailing-edge phase dimmable, dim2warm, IP65, with connection box

NEW

Lamp: LED, colour rendering: CRI > 80, power: 6 W, beam angle: 38°, material: aluminium / polycarbonate, includes 3-pole connection box suitable for through-wiring

| Article no. | Colour | Lumin. flux | Colour temp. | Price in € |
|-------------|---------------------------|-------------|-------------------|------------|
| 12647153DW | NEW matt nickel | 410 lm | 3,000 K - 1,800 K | 54.70 |
| 12647173DW | NEW textured white | 410 lm | 3,000 K - 1,800 K | 51.20 |
| 12647183DW | NEW textured black | 410 lm | 3,000 K - 1,800 K | 51.20 |

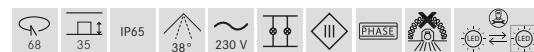

IP65 when installed in closed ceilings

These items are subject to discount group 1.



LAKIL.

LED recessed spotlight.

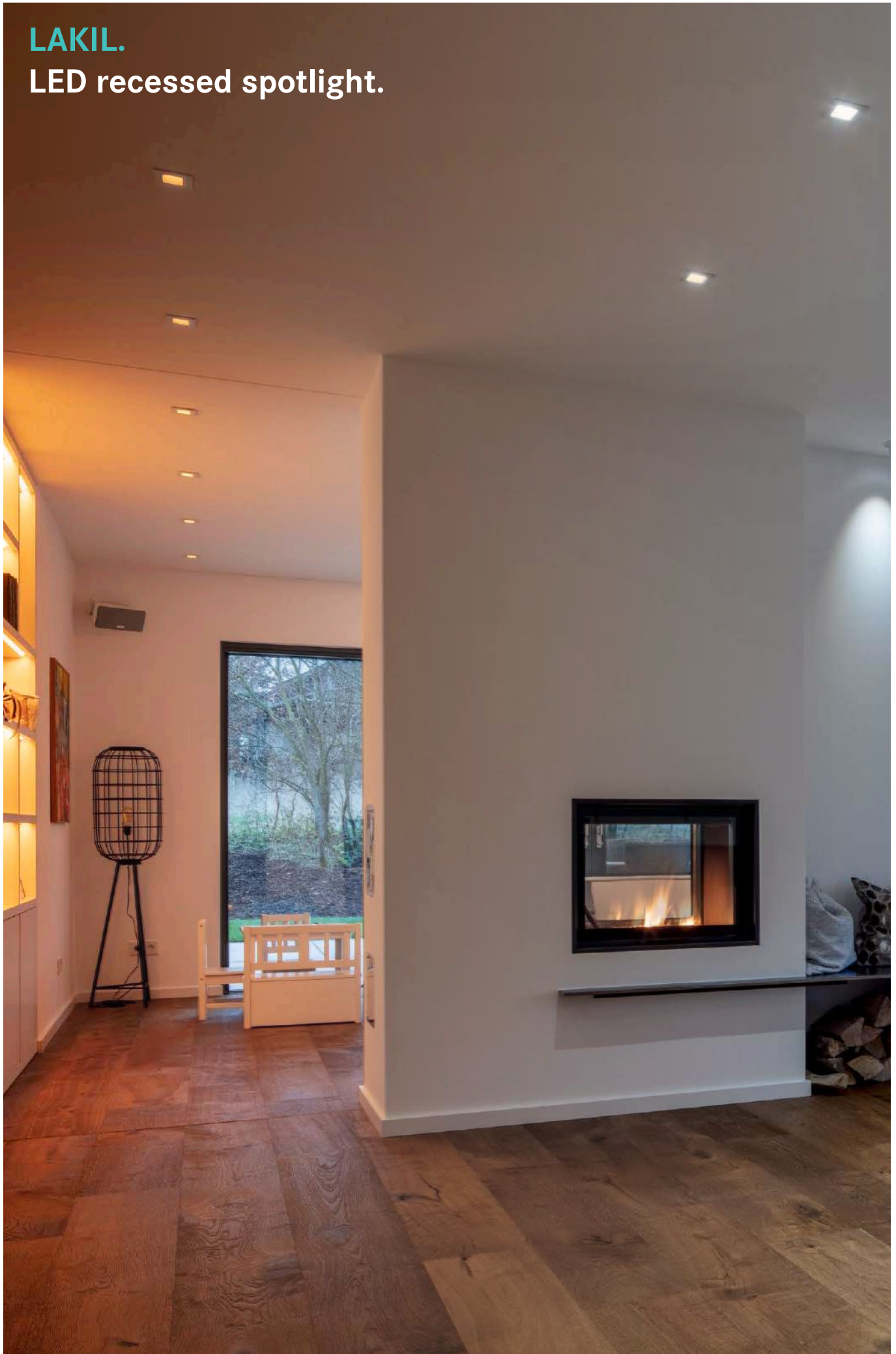

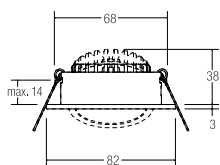

dim²warm

LAKIL-R LED recessed spotlight, dim2warm NEW

If the light is dimmed, the colour temperature is reduced.

Lamp: LED, colour rendering: CRI > 80, power: 6 W, beam angle: 38°, material: aluminium / polycarbonate

You can find the corresponding 350 mA converter from page 198 onwards.

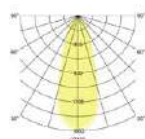

| Article no. | Colour | Lumin. flux | Colour temp. | Price in € |
|-------------|---|-------------|-------------------|------------|
| 12461073 | white matt | 460 lm | 3,000 K - 1,800 K | 79.40 |
| 12461083 | NEW matt black | 460 lm | 3,000 K - 1,800 K | 79.40 |
| 12461253 | matt aluminium | 460 lm | 3,000 K - 1,800 K | 84.90 |



These items are subject to discount group 1.

dim²warm

LAKIL-R LED recessed spotlight set, dim2warm, trailing-edge phase dimmable NEW

If the light is dimmed, the colour temperature is reduced. Set includes converter for 230 V mains voltage, trailing-edge phase dimmable, converter dimensions: L 110 x W 50 x H 19 mm

Lamp: LED, colour rendering: CRI > 80, power: 6 W, beam angle: 38°, material: aluminium / polycarbonate

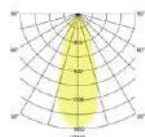

| Article no. | Colour | Lumin. flux | Colour temp. | Price in € |
|-------------|---|-------------|-------------------|------------|
| 39461073 | white matt | 460 lm | 3,000 K - 1,800 K | 108.90 |
| 39461083 | NEW matt black | 460 lm | 3,000 K - 1,800 K | 108.90 |
| 39461253 | matt aluminium | 460 lm | 3,000 K - 1,800 K | 113.90 |

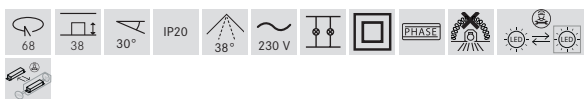

These items are subject to discount group 1.

Sizes in mm | All prices are recommended retail prices (RRP) in euros without VAT. Errors excepted. | Orders are placed in accordance with our General Terms and Conditions of Sale printed on page 486 onwards.

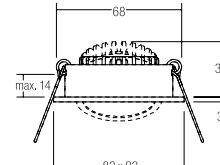

dim²warm

LAKIL-S LED recessed spotlight, dim2warm NEW

If the light is dimmed, the colour temperature is reduced.

Lamp: LED, colour rendering: CRI > 80, power: 6 W, beam angle: 38°, material: aluminium / polycarbonate

You can find the corresponding 350 mA converter from page 199 onwards.

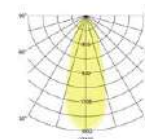

| Article no. | Colour | Lumin. flux | Colour temp. | Price in € |
|-------------|---|-------------|-------------------|------------|
| 12462073 | white matt | 460 lm | 3,000 K - 1,800 K | 83.30 |
| 12462083 | NEW matt black | 460 lm | 3,000 K - 1,800 K | 83.30 |
| 12462253 | matt aluminium | 460 lm | 3,000 K - 1,800 K | 88.80 |



These items are subject to discount group 1.

dim²warm

LAKIL-S LED recessed spotlight set, dim2warm, trailing-edge phase dimmable NEW

If the light is dimmed, the colour temperature is reduced. Set includes converter for 230 V mains voltage, trailing-edge phase dimmable, converter dimensions: L 110 x W 50 x H 19 mm

Lamp: LED, colour rendering: CRI > 80, power: 6 W, beam angle: 38°, material: aluminium / polycarbonate

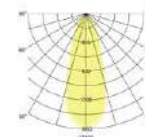

| Article no. | Colour | Lumin. flux | Colour temp. | Price in € |
|-------------|---|-------------|-------------------|------------|
| 39462073 | white | 460 lm | 3,000 K - 1,800 K | 112.90 |
| 39462083 | NEW matt black | 460 lm | 3,000 K - 1,800 K | 112.90 |
| 39462253 | matt aluminium | 460 lm | 3,000 K - 1,800 K | 117.50 |

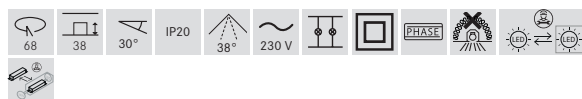

These items are subject to discount group 1.

TIRREL.

LED recessed spotlight.

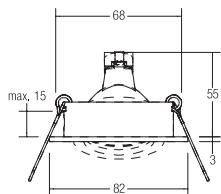

TIRREL-R recessed spotlight, GX5,3

NEW

Lamp: for LED retrofit lamp, lamp holder: GX5,3, power: 50 W, material: aluminium

| Article no. | Colour | Price in € |
|-------------|-------------------------------|------------|
| 0063.02 | chrome glossy | 25.90 |
| 0063.07 | matt white | 24.80 |
| 0063.17 | NEW textured white | 24.80 |
| 0063.08 | black matt | 24.80 |
| 0063.78 | NEW vinyl black glossy | 28.40 |
| 0063.25 | matt aluminium | 24.80 |
| 0063.63 | matt champagne | 30.80 |
| 0063.64 | matt titanium | 30.80 |

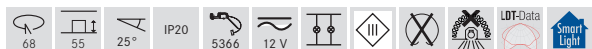

These items are subject to discount group 1.

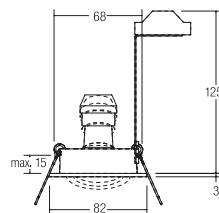

TIRREL-R recessed spotlight, GU10

NEW

Includes bracket with GU10 lamp holder for standard-compliant strain relief.

Lamp: for LED retrofit lamp, lamp holder: GU10, power: 50 W, material: aluminium

| Article no. | Colour | Price in € |
|-------------|-------------------------------|------------|
| 36143020 | chrome glossy | 38.90 |
| 36143070 | matt white | 37.90 |
| 36143170 | NEW textured white | 37.90 |
| 36143080 | black matt | 37.90 |
| 36143780 | NEW vinyl black glossy | 41.50 |
| 36143250 | matt aluminium | 37.90 |
| 36143630 | matt champagne | 42.90 |
| 36143640 | matt titanium | 42.90 |



These items are subject to discount group 1.



NEW: vinyl black glossy

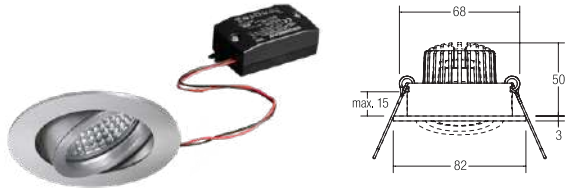

TIRREL-R LED recessed spotlight set, switchable

NEW

Set includes converter for 230 V mains voltage, switchable, converter dimensions: L 68 x W 35 x H 21 mm

Lamp: LED, colour rendering: CRI > 80, power: 6 W, beam angle: 38°, material: aluminium / glass / plastic

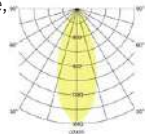

| Article no. | Colour | Lumin. flux | Colour temp. | Price in € |
|---------------------|--------------------|-------------|--------------|------------|
| 38143023 | chrome glossy | 680 lm | 3,000 K | 115.90 |
| 38143073 | matt white | 680 lm | 3,000 K | 114.90 |
| 38143173 NEW | textured white | 680 lm | 3,000 K | 114.90 |
| 38143083 | black matt | 680 lm | 3,000 K | 114.90 |
| 38143783 NEW | vinyl black glossy | 680 lm | 3,000 K | 118.50 |
| 38143253 | matt aluminium | 680 lm | 3,000 K | 114.90 |
| 38143633 | matt champagne | 680 lm | 3,000 K | 119.90 |
| 38143643 | matt titanium | 680 lm | 3,000 K | 119.90 |



These items are subject to discount group 1.



TIRREL-R LED recessed spotlight set, trailing-edge phase dimmable

NEW

Set includes converter for 230 V mains voltage, trailing-edge phase dimmable, converter dimensions: L 110 x W 50 x H 19 mm

Lamp: LED, colour rendering: CRI > 80, power: 6 W, beam angle: 38°, material: aluminium / glass / plastic

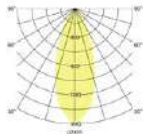

| Article no. | Colour | Lumin. flux | Colour temp. | Price in € |
|---------------------|--------------------|-------------|--------------|------------|
| 39143023 | chrome glossy | 680 lm | 3,000 K | 120.90 |
| 39143073 | matt white | 680 lm | 3,000 K | 118.90 |
| 39143173 NEW | textured white | 680 lm | 3,000 K | 118.90 |
| 39143083 | black matt | 680 lm | 3,000 K | 118.90 |
| 39143783 NEW | vinyl black glossy | 680 lm | 3,000 K | 122.50 |
| 39143253 | matt aluminium | 680 lm | 3,000 K | 118.90 |
| 39143633 | matt champagne | 680 lm | 3,000 K | 124.90 |
| 39143643 | matt titanium | 680 lm | 3,000 K | 124.90 |

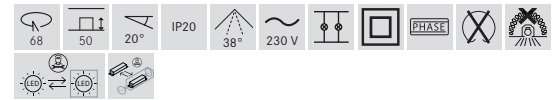

These items are subject to discount group 1.



TIRREL-R LED recessed spotlight set, trailing-edge phase dimmable (round converter)

NEW

Set includes round converter for 230 V mains voltage, trailing-edge phase dimmable, converter dimensions: D 51 x H 24 mm

Lamp: LED, colour rendering: CRI > 80, power: 6 W, beam angle: 38°, material: aluminium / glass / plastic

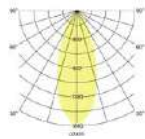

| Article no. | Colour | Lumin. flux | Colour temp. | Price in € |
|---------------------|--------------------|-------------|--------------|------------|
| 40143023 | chrome glossy | 680 lm | 3,000 K | 130.90 |
| 40143073 | matt white | 680 lm | 3,000 K | 128.90 |
| 40143173 NEW | textured white | 680 lm | 3,000 K | 128.90 |
| 40143083 | black matt | 680 lm | 3,000 K | 128.90 |
| 40143783 NEW | vinyl black glossy | 680 lm | 3,000 K | 132.50 |
| 40143253 | matt aluminium | 680 lm | 3,000 K | 128.90 |
| 40143633 | matt champagne | 680 lm | 3,000 K | 134.90 |
| 40143643 | matt titanium | 680 lm | 3,000 K | 134.90 |

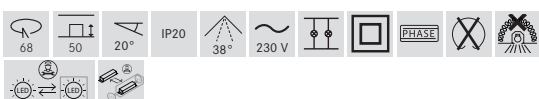

These items are subject to discount group 1.



TIRREL-R LED recessed spotlight set, DALI dimmable, with connection box

NEW

Set includes converter for 230 V mains voltage, DALI-2 dimmable, without afterglow effect, converter dimensions: L 130 x W 42 x H 22 mm

Lamp: LED, colour rendering: CRI > 80, power: 6 W, beam angle: 38°, material: aluminium / glass / plastic, includes 5-pole connection box

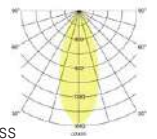

| Article no. | Colour | Lumin. flux | Colour temp. | Price in € |
|---------------------|--------------------|-------------|--------------|------------|
| 41443023 | chrome glossy | 680 lm | 3,000 K | 167.90 |
| 41443073 | matt white | 680 lm | 3,000 K | 166.90 |
| 41443173 NEW | textured white | 680 lm | 3,000 K | 166.90 |
| 41443083 | black matt | 680 lm | 3,000 K | 166.90 |
| 41443783 NEW | vinyl black glossy | 680 lm | 3,000 K | 170.50 |
| 41443253 | matt aluminium | 680 lm | 3,000 K | 166.90 |
| 41443633 | matt champagne | 680 lm | 3,000 K | 171.90 |
| 41443643 | matt titanium | 680 lm | 3,000 K | 171.90 |

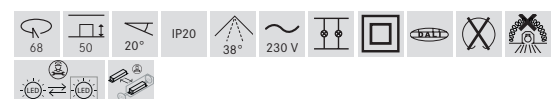

These items are subject to discount group 1.

TIRREL.

LED recessed spotlight.

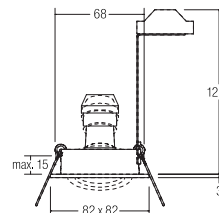
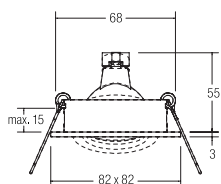

TIRREL-S recessed spotlight, GX5,3

NEW

Lamp: for LED retrofit lamp, lamp holder: GX5,3, power: 50 W, material: aluminium

| Article no. | Colour | Price in € |
|-------------|-------------------------------|------------|
| 0065.02 | chrome glossy | 28.60 |
| 0065.07 | matt white | 27.00 |
| 0065.17 | NEW textured white | 27.00 |
| 0065.08 | black matt | 27.00 |
| 0065.78 | NEW vinyl black glossy | 30.60 |
| 0065.25 | matt aluminium | 27.00 |
| 0065.63 | matt champagne | 33.00 |
| 0065.64 | matt titanium | 33.00 |



These items are subject to discount group 1.

TIRREL-S recessed spotlight, GU10

NEW

Includes bracket with GU10 lamp holder for standard-compliant strain relief.

Lamp: for LED retrofit lamp, lamp holder: GU10, power: 50 W, material: aluminium

| Article no. | Colour | Price in € |
|-------------|-------------------------------|------------|
| 36144020 | chrome glossy | 41.90 |
| 36144070 | matt white | 39.90 |
| 36144170 | NEW textured white | 39.90 |
| 36144080 | black matt | 39.90 |
| 36144780 | NEW vinyl black glossy | 43.50 |
| 36144250 | matt aluminium | 39.90 |
| 36144630 | matt champagne | 45.90 |
| 36144640 | matt titanium | 45.90 |



These items are subject to discount group 1.

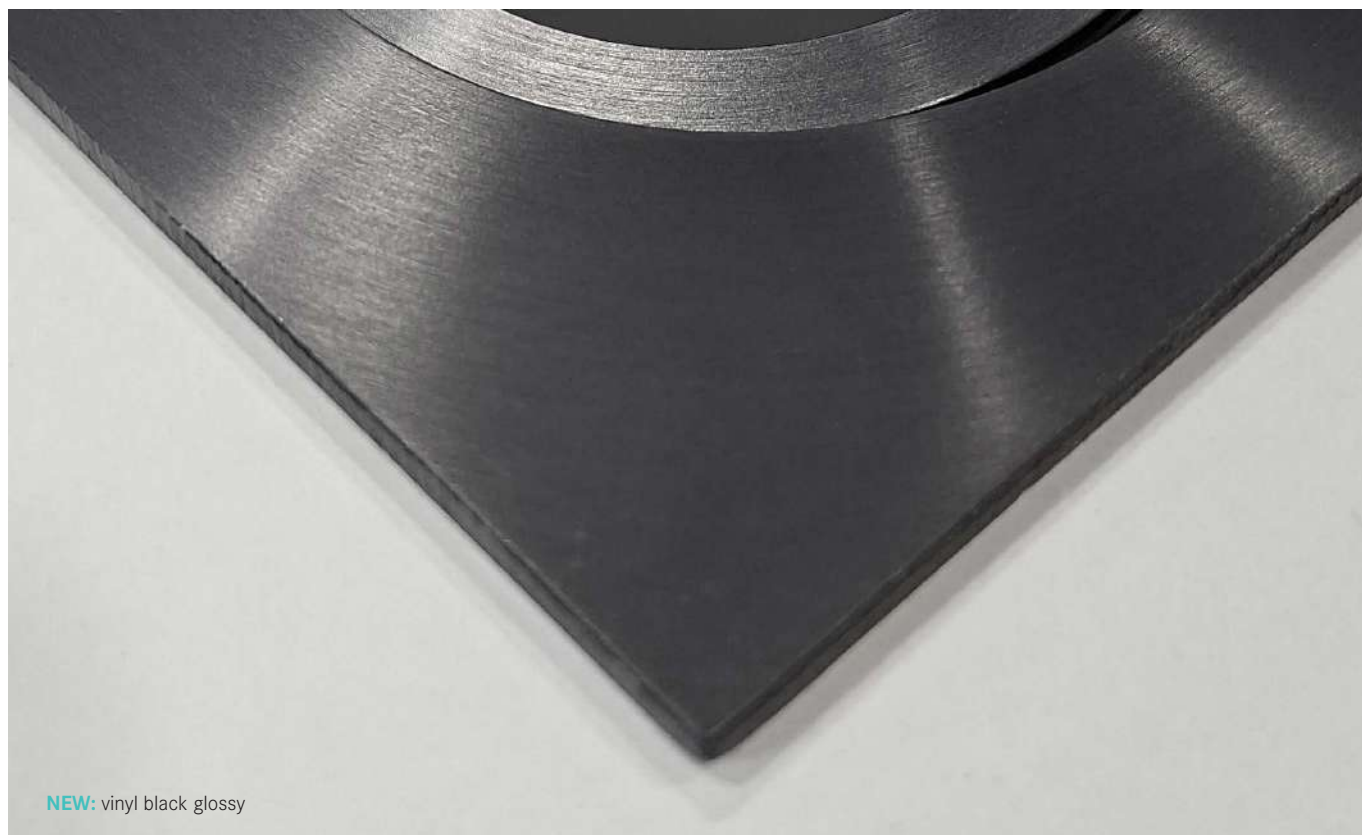

NEW: vinyl black glossy

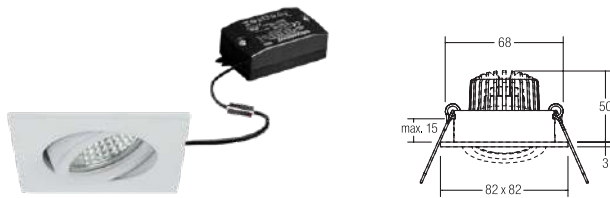

TIRREL-S LED recessed spotlight set, switchable

NEW

Set includes converter for 230 V mains voltage, switchable, converter dimensions: L 68 x W 35 x H 21 mm

Lamp: LED, colour rendering: CRI > 80, power: 6 W, beam angle: 38°, material: aluminium / glass / plastic

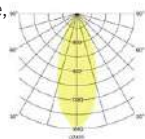

| Article no. | Colour | Lumin. flux | Colour temp. | Price in € |
|-------------|-------------------------------|-------------|--------------|------------|
| 38144023 | chrome glossy | 680 lm | 3,000 K | 118.90 |
| 38144073 | matt white | 680 lm | 3,000 K | 116.90 |
| 38144173 | NEW textured white | 680 lm | 3,000 K | 116.90 |
| 38144083 | black matt | 680 lm | 3,000 K | 116.90 |
| 38144783 | NEW vinyl black glossy | 680 lm | 3,000 K | 120.50 |
| 38144253 | matt aluminium | 680 lm | 3,000 K | 116.90 |
| 38144633 | matt champagne | 680 lm | 3,000 K | 122.90 |
| 38144643 | matt titanium | 680 lm | 3,000 K | 122.90 |



These items are subject to discount group 1.



TIRREL-S LED recessed spotlight set, trailing-edge phase dimmable

NEW

Set includes converter for 230 V mains voltage, trailing-edge phase dimmable, converter dimensions: L 110 x W 50 x H 19 mm

Lamp: LED, colour rendering: CRI > 80, power: 6 W, beam angle: 38°, material: aluminium / glass / plastic

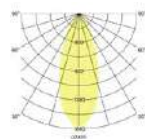

| Article no. | Colour | Lumin. flux | Colour temp. | Price in € |
|-------------|-------------------------------|-------------|--------------|------------|
| 39144023 | chrome glossy | 680 lm | 3,000 K | 123.90 |
| 39144073 | matt white | 680 lm | 3,000 K | 121.90 |
| 39144173 | NEW textured white | 680 lm | 3,000 K | 121.90 |
| 39144083 | black matt | 680 lm | 3,000 K | 121.90 |
| 39144783 | NEW vinyl black glossy | 680 lm | 3,000 K | 125.50 |
| 39144253 | matt aluminium | 680 lm | 3,000 K | 121.90 |
| 39144633 | matt champagne | 680 lm | 3,000 K | 127.90 |
| 39144643 | matt titanium | 680 lm | 3,000 K | 127.90 |



These items are subject to discount group 1.



TIRREL-S LED recessed spotlight set, trailing-edge phase dimmable (round converter)

NEW

Set includes round converter for 230 V mains voltage, trailing-edge phase dimmable, converter dimensions: D 51 x H 24 mm

Lamp: LED, colour rendering: CRI > 80, power: 6 W, beam angle: 38°, material: aluminium / glass / plastic

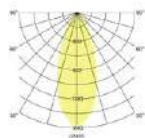

| Article no. | Colour | Lumin. flux | Colour temp. | Price in € |
|-------------|-------------------------------|-------------|--------------|------------|
| 40144023 | chrome glossy | 680 lm | 3,000 K | 133.90 |
| 40144073 | matt white | 680 lm | 3,000 K | 131.90 |
| 40144173 | NEW textured white | 680 lm | 3,000 K | 131.90 |
| 40144083 | black matt | 680 lm | 3,000 K | 131.90 |
| 40144783 | NEW vinyl black glossy | 680 lm | 3,000 K | 135.50 |
| 40144253 | matt aluminium | 680 lm | 3,000 K | 131.90 |
| 40144633 | matt champagne | 680 lm | 3,000 K | 137.90 |
| 40144643 | matt titanium | 680 lm | 3,000 K | 137.90 |

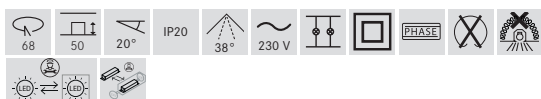

These items are subject to discount group 1.



TIRREL-S LED recessed spotlight set, DALI dimmable, with connection box

NEW

Set includes converter for 230 V mains voltage, DALI-2 dimmable, without afterglow effect, converter dimensions: L 130 x W 42 x H 22 mm

Lamp: LED, colour rendering: CRI > 80, power: 6 W, beam angle: 38°, material: aluminium / glass / plastic, includes 5-pole connection box

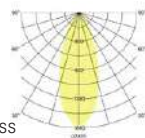

| Article no. | Colour | Lumin. flux | Colour temp. | Price in € |
|-------------|-------------------------------|-------------|--------------|------------|
| 41444023 | chrome glossy | 680 lm | 3,000 K | 170.90 |
| 41444073 | matt white | 680 lm | 3,000 K | 169.90 |
| 41444173 | NEW textured white | 680 lm | 3,000 K | 169.90 |
| 41444083 | black matt | 680 lm | 3,000 K | 169.90 |
| 41444783 | NEW vinyl black glossy | 680 lm | 3,000 K | 173.50 |
| 41444253 | matt aluminium | 680 lm | 3,000 K | 169.90 |
| 41444633 | matt champagne | 680 lm | 3,000 K | 174.90 |
| 41444643 | matt titanium | 680 lm | 3,000 K | 174.90 |

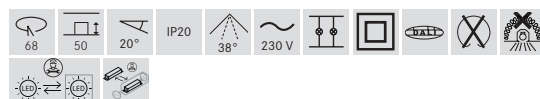

These items are subject to discount group 1.

ALTERO.

LED recessed downlight.

ALTERO.

Modular product series with interchangeable luminaire covers. For flexible lighting solutions for changing room concepts from neutral to accentuated.

Colours and shapes.

Numerous options for different furnishing highlights: you set the accents.

Other versions.

You can find the static versions of the ALTERO in the Brumberg main catalogue on pages 120 - 121.





NEW: NOW TunableWhite

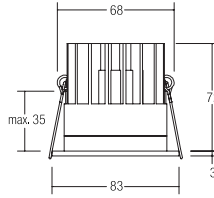

ALTERO-R LED recessed downlight, TunableWhite, IP44

NEW

Lamp: LED, colour rendering: CRI > 90, power: 8.8 W, beam angle: 33°, material: aluminium / glass / plastic

| Article no. | Colour | Colour temp. | Price in € |
|-------------|-------------------------------------|-------------------|------------|
| 12035174TW | NEW textured white | 2,700 K – 6,500 K | 152.20 |
| 12035184TW | NEW textured black | 2,700 K – 6,500 K | 152.20 |
| 12035404TW | NEW textured white / chrome | 2,700 K – 6,500 K | 152.20 |
| 12035554TW | NEW textured white / textured black | 2,700 K – 6,500 K | 152.20 |
| 12035754TW | NEW textured white / textured gold | 2,700 K – 6,500 K | 152.20 |
| 12035854TW | NEW textured black / textured gold | 2,700 K – 6,500 K | 152.20 |

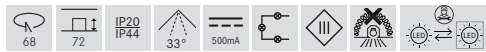

IP44 for installation in closed ceilings, the complete cover can be replaced on site via bayonet.

These items are subject to discount group 1.



NEW: NOW dim2warm

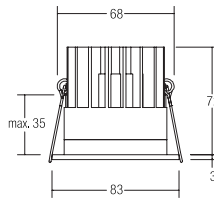

ALTERO-R LED recessed downlight, dim2warm, IP44

NEW

If the light is dimmed, the colour temperature is reduced.

Lamp: LED, colour rendering: CRI > 90, power: 11.8 W, beam angle: 33°, material: aluminium / glass / plastic

| Article no. | Colour | Lumin. flux | Colour temp. | Price in € |
|-------------|-------------------------------------|-------------|-------------------|------------|
| 12035173DW | NEW textured white | 620 lm | 3,000 K – 1,800 K | 152.20 |
| 12035183DW | NEW textured black | 620 lm | 3,000 K – 1,800 K | 152.20 |
| 12035403DW | NEW textured white / chrome | 620 lm | 3,000 K – 1,800 K | 152.20 |
| 12035553DW | NEW textured white / textured black | 620 lm | 3,000 K – 1,800 K | 152.20 |
| 12035753DW | NEW textured white / textured gold | 620 lm | 3,000 K – 1,800 K | 152.20 |
| 12035853DW | NEW textured black / textured gold | 620 lm | 3,000 K – 1,800 K | 152.20 |



IP44 for installation in closed ceilings, the complete cover can be replaced on site via bayonet.

These items are subject to discount group 1.

Sizes in mm | All prices are recommended retail prices (RRP) in euros without VAT. Errors excepted. | Orders are placed in accordance with our General Terms and Conditions of Sale printed on page 486 onwards.



NEW: NOW TunableWhite

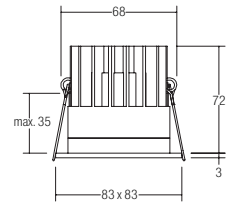

ALTERO-S LED recessed downlight, TunableWhite, IP44

NEW

Lamp: LED, colour rendering: CRI > 90, power: 8.8 W, beam angle: 33°, material: aluminium / glass / plastic

| Article no. | Colour | Colour temp. | Price in € |
|-------------|-------------------------------------|-------------------|------------|
| 12036174TW | NEW textured white | 2,700 K – 6,500 K | 152.20 |
| 12036184TW | NEW textured black | 2,700 K – 6,500 K | 152.20 |
| 12036404TW | NEW textured white / chrome | 2,700 K – 6,500 K | 152.20 |
| 12036554TW | NEW textured white / textured black | 2,700 K – 6,500 K | 152.20 |
| 12036754TW | NEW textured white / textured gold | 2,700 K – 6,500 K | 152.20 |
| 12036854TW | NEW textured black / textured gold | 2,700 K – 6,500 K | 152.20 |

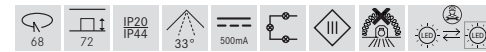

IP44 for installation in closed ceilings, the complete cover can be replaced on site via bayonet.

These items are subject to discount group 1.



NEW: NOW dim2warm

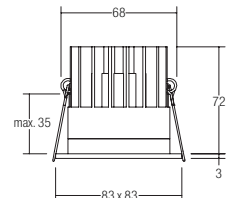

ALTERO-S LED recessed downlight, dim2warm, IP44

NEW

If the light is dimmed, the colour temperature is reduced.

Lamp: LED, colour rendering: CRI > 90, power: 11.8 W, beam angle: 33°, material: aluminium / glass / plastic

| Article no. | Colour | Lumin. flux | Colour temp. | Price in € |
|-------------|-------------------------------------|-------------|-------------------|------------|
| 12036173DW | NEW textured white | 620 lm | 3,000 K – 1,800 K | 152.20 |
| 12036183DW | NEW textured black | 620 lm | 3,000 K – 1,800 K | 152.20 |
| 12036403DW | NEW textured white / chrome | 620 lm | 3,000 K – 1,800 K | 152.20 |
| 12036553DW | NEW textured white / textured black | 620 lm | 3,000 K – 1,800 K | 152.20 |
| 12036753DW | NEW textured white / textured gold | 620 lm | 3,000 K – 1,800 K | 152.20 |
| 12036853DW | NEW textured black / textured gold | 620 lm | 3,000 K – 1,800 K | 152.20 |

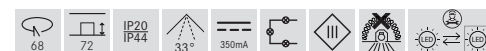

IP44 for installation in closed ceilings, the complete cover can be replaced on site via bayonet.

These items are subject to discount group 1.

BINATO.

LED recessed spotlight.

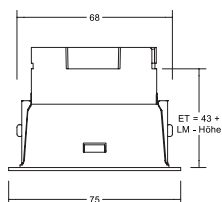

BINATO recessed spotlight, rotatable and swivelling, **without LED module**

NEW

All Brumberg MR16 LED modules can be used for the BINATO installation unit. The installation depth of the luminaire depends on the LED module used (here: 43 mm, plus the height of the LED module). The LED module is not included in the scope of supply of the installation unit.

Lamp: for LED, power: max. 14 W, material: aluminium / plastic, includes leaf spring attachment

| Article no. | Colour | Price in € |
|-------------|--|------------|
| 20173170 | NEW textured white / inside matt white | 44.90 |
| 20173550 | NEW textured white / inside matt black | 44.90 |
| 20173770 | NEW textured white / inside matt silver | 44.90 |
| 20173740 | NEW textured white / inside glossy chrome | 44.90 |
| 20173760 | NEW textured white / inside matt gold | 44.90 |
| 20173180 | NEW textured black / inside matt black | 44.90 |
| 20173560 | NEW textured black / inside matt white | 44.90 |
| 20173870 | NEW textured black / inside matt silver | 44.90 |
| 20173840 | NEW textured black / inside glossy chrome | 44.90 |
| 20173860 | NEW textured black / inside matt gold | 44.90 |



These items are subject to discount group 1.



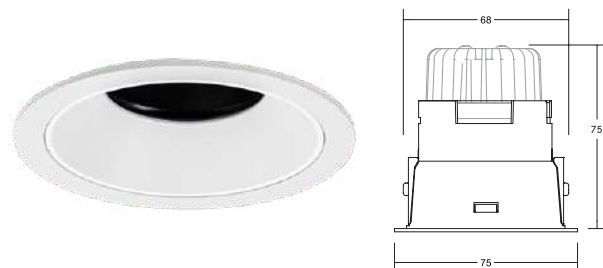
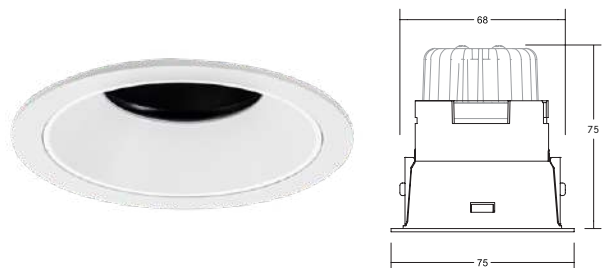

BINATO LED recessed spotlight set, rotatable and swivelling, trailing-edge phase dimmable

NEW

Set incl. converter for 230 V mains voltage, trailing-edge phase dimmable, converter dimensions: L 110 x W 50 x H 19 mm

Lamp: LED, colour rendering: CRI > 80, power: 6 W, beam angle: 38°, material: aluminium / plastic, includes leaf spring attachment

| Article no. | Colour | Lumin. flux | Colour temp. | Price in € |
|-------------|---|-------------|-------------------|------------|
| 39173727 | NEW textured white / inside matt white | 600 lm | 2,700 K | 145.00 |
| 39173173 | NEW textured white / inside matt white | 680 lm | 3,000 K | 145.00 |
| 39173174 | NEW textured white / inside matt white | 720 lm | 4,000 K | 145.00 |
| 39173173DW | NEW textured white / inside matt white | 460 lm | 3,000 K - 1,800 K | 159.90 |
| 39173827 | NEW textured black / inside matt black | 600 lm | 2,700 K | 145.00 |
| 39173183 | NEW textured black / inside matt black | 680 lm | 3,000 K | 145.00 |
| 39173184 | NEW textured black / inside matt black | 720 lm | 4,000 K | 145.00 |
| 39173183DW | NEW textured black / inside matt black | 460 lm | 3,000 K - 1,800 K | 159.90 |

BINATO LED recessed spotlight set, rotatable and swivelling, DALI dimmable, with connection box

NEW

Set includes converter for 230 V mains voltage, DALI-2 dimmable, converter dimensions: L 130 x W 42 x H 22 mm

Lamp: LED, colour rendering: CRI > 80, power: 6 W, beam angle: 38°, material: aluminium / plastic, includes leaf spring attachment, with 5-pole connection box

| Article no. | Colour | Lumin. flux | Colour temp. | Price in € |
|-------------|---|-------------|-------------------|------------|
| 41473727 | NEW textured white / inside matt white | 600 lm | 2,700 K | 199.90 |
| 41473173 | NEW textured white / inside matt white | 680 lm | 3,000 K | 199.90 |
| 41473174 | NEW textured white / inside matt white | 720 lm | 4,000 K | 199.90 |
| 41473173DW | NEW textured white / inside matt white | 460 lm | 3,000 K - 1,800 K | 199.90 |
| 41473827 | NEW textured black / inside matt black | 600 lm | 2,700 K | 199.90 |
| 41473183 | NEW textured black / inside matt black | 680 lm | 3,000 K | 199.90 |
| 41473184 | NEW textured black / inside matt black | 720 lm | 4,000 K | 199.90 |
| 41473183DW | NEW textured black / inside matt black | 460 lm | 3,000 K - 1,800 K | 199.90 |

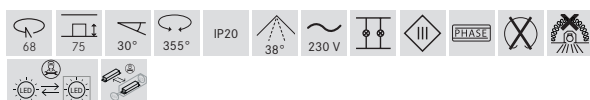

These items are subject to discount group 1.

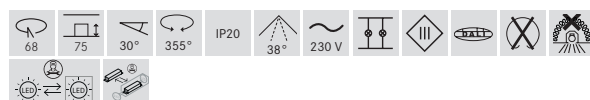

These items are subject to discount group 1.

LEDspark.

LED recessed light spot.

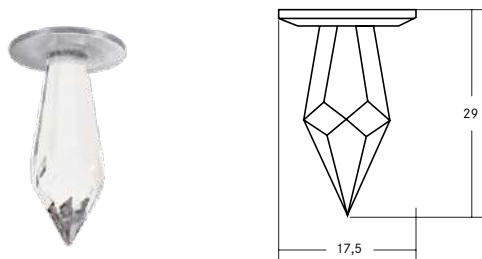

LEDspark MAXI LED recessed light spot

NEW

Lamp: LED, power: 0.3 W, material: brass / crystal glass, includes 1,800 mm connection cable

| Article no. | Colour | Colour temp. | Price in € |
|-------------|-----------------|--------------|------------|
| 12003034 | NEW matt chrome | 4,000 K | 47.50 |

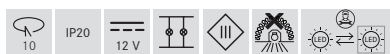

The installation ring is also available in white, black, chrome or gold on request.

This item is subject to discount group 1.

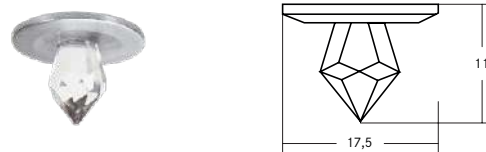

LEDspark MINI LED recessed light spot

NEW

Lamp: LED, power: 0.3 W, material: brass / crystal glass, includes 1,800 mm connection cable

| Article no. | Colour | Colour temp. | Price in € |
|-------------|-----------------|--------------|------------|
| 12002034 | NEW matt chrome | 4,000 K | 45.00 |

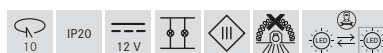

The installation ring is also available in white, black, chrome or gold on request.

This item is subject to discount group 1.



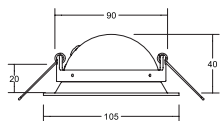

NEW: NOW
Large rotation
(355°) and swivel-
ling (40°) range



KAMUTA LED recessed spotlight

NEW

Lamp: LED, colour rendering: CRI > 80, power: 5 W, beam angle: 36°, material: aluminium / PMMA

| Article no. | Colour | Lumin. flux | Colour temp. | Price in € |
|-------------|---------------------------|-------------|--------------|------------|
| 12431173 | NEW textured white | 680 lm | 3,000 K | 59.50 |
| 12431183 | NEW textured black | 680 lm | 3,000 K | 59.50 |

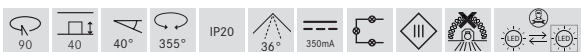

These items are subject to discount group 1.

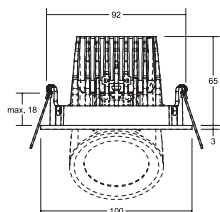

NEW: NOW
in black



KARYL LED recessed spotlight

NEW

Lamp: LED, colour rendering: CRI > 80, power: 13 W, beam angle: 36°, material: aluminium / PMMA

| Article no. | Colour | Lumin. flux | Colour temp. | Price in € |
|-------------|-----------------------|-------------|--------------|------------|
| 12401073 | matt white | 1,320 lm | 3,000 K | 114.90 |
| 12401083 | NEW matt black | 1,320 lm | 3,000 K | 114.90 |



These items are subject to discount group 1.

PROTECT.

Recessed downlight.

IP44 downlight for almost all indoor areas.



PROTECT-R Recessed downlight, IP44, without LED module

NEW

All Brumberg MR16 LED modules can be used for the PROTECT installation unit. The installation depth of the luminaire depends on the LED module used (here: 3 mm, plus the height of the LED module). The LED module is not included in the scope of supply of the installation unit.

Lamp: for LED, power: max. 14 W, material: aluminium / glass, includes glass cover

| Article no. | Colour | Price in € |
|-------------|--|------------|
| 20043170 | NEW textured white, satinised glass cover | 24.90 |
| 20043180 | NEW textured black, satinised glass cover | 24.90 |
| 20044170 | NEW textured white, clear glass cover | 24.90 |
| 20044180 | NEW textured black, clear glass cover | 24.90 |



IP44 when installed in closed ceilings

These items are subject to discount group 1.

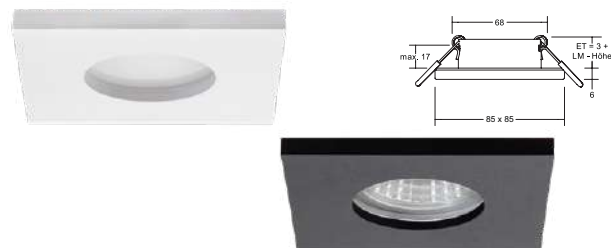

PROTECT-S Recessed downlight, IP44, without LED module

NEW

All Brumberg MR16 LED modules can be used for the PROTECT installation unit. The installation depth of the luminaire depends on the LED module used (here: 3 mm, plus the height of the LED module). The LED module is not included in the scope of supply of the installation unit.

Lamp: for LED, power: max. 14 W, material: aluminium / glass, includes glass cover

| Article no. | Colour | Price in € |
|-------------|--|------------|
| 20045170 | NEW textured white, satinised glass cover | 28.90 |
| 20045180 | NEW textured black, satinised glass cover | 28.90 |
| 20046170 | NEW textured white, clear glass cover | 28.90 |
| 20046180 | NEW textured black, clear glass cover | 28.90 |



IP44 when installed in closed ceilings

These items are subject to discount group 1.

X-FLAT-S.

LED recessed / surface-mounted downlight.

Extremely flat recessed and surface-mounted light.

For technical safety, easy installation and simple, reverse polarity protected wiring.

Thanks to its ultra-flat luminaire height, X-Flat-S can be integrated into a wide variety of room, surface and furniture concepts.

The luminaire is suitable both for recessed installation with screw mounting and as a surface-mounted luminaire for furniture. The magnetic cover hides the pre-drilled holes required for surface mounting.

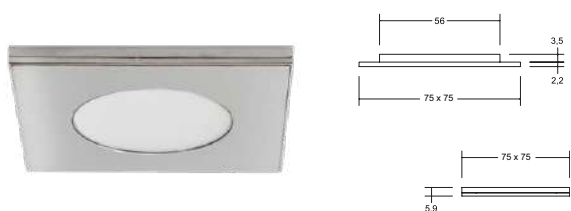

NEW: NOW
in square
version

X-FLAT-S LED recessed / surface-mounted downlight

NEW

Light optimised for installation in furniture and wooden materials.

This luminaire can be used both as a recessed luminaire (hole cut-out: 56 mm, installation depth: 3.5 mm, installation height: 2.2 mm) and as a surface-mounted luminaire (total height: 5.9 mm) using the surface-mounted housing supplied.

Outer edge matt nickel, magnetically attached cover in colour according to article table.

Lamp: LED, colour rendering: CRI 81, power: 2.6 W, beam angle: 120°, material: aluminium / steel / plastic, includes 2,000 mm connection cable

This luminaire can be used both as a recessed luminaire (hole cut-out: 56 mm, installation depth: 3.5 mm, installation height: 2.2 mm) and as a surface-mounted luminaire (total height: 5.9 mm) using the surface-mounted housing supplied.

Outer edge matt nickel, magnetically attached cover in colour according to article table.

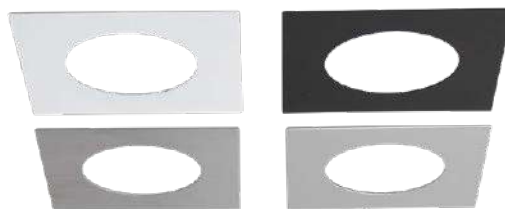

| Article no. | Colour | Colour temp. | Price in € |
|-------------|--------------------------------|--------------|------------|
| 12165023 | NEW chrome cover glossy | 3,000 K | 61.00 |
| 12165073 | NEW white cover matt | 3,000 K | 61.00 |
| 12165083 | NEW matt black cover | 3,000 K | 61.00 |
| 12165153 | NEW matt nickel cover | 3,000 K | 61.00 |

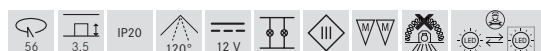

These items are subject to discount group 1.

ZONDRA.

LED recessed downlight set.

From UGR < 16 to decorative design.

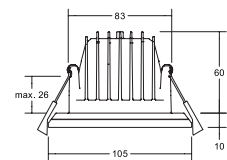
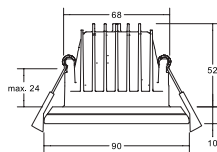

ZONDRA LED recessed downlight set, direct, trailing-edge phase dimmable, UGR < 16

NEW

Lamp: LED, colour rendering: CRI > 80, glare rating: UGR < 16, power: 10 W, beam angle: 24°, material: aluminium / plastic

| Article no. | Colour | Lumin. flux | Colour temp. | Price in € |
|-------------|---------------------------|-------------|--------------|------------|
| 39336173 | NEW textured white | 790 lm | 3,000 K | 70.40 |
| 39336183 | NEW textured black | 790 lm | 3,000 K | 70.40 |

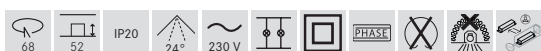

These items are subject to discount group 1.

ZONDRA LED recessed downlight set, direct, trailing-edge phase dimmable, UGR < 16

NEW

Lamp: LED, colour rendering: CRI > 80, glare rating: UGR < 16, power: 13 W, beam angle: 24°, material: aluminium / plastic

| Article no. | Colour | Lumin. flux | Colour temp. | Price in € |
|-------------|---------------------------|-------------|--------------|------------|
| 39337173 | NEW textured white | 1,190 lm | 3,000 K | 75.00 |
| 39337183 | NEW textured black | 1,190 lm | 3,000 K | 75.00 |

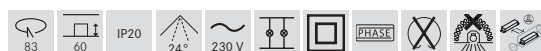

These items are subject to discount group 1.

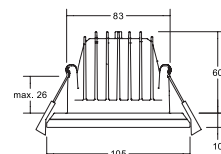
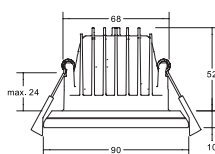

ZONDRA LED recessed downlight set, direct / indirect, trailing-edge phase dimmable NEW

LED recessed downlight with 550 lm direct and 110 lm indirect light component. Light components can be dimmed simultaneously in the same ratio.

Lamp: LED, colour rendering: CRI > 80, power: 10 W, beam angle: 24°, material: aluminium / plastic

| Article no. | Colour | Lumin. flux | Colour temp. | Price in € |
|-------------|---|-------------|--------------|------------|
| 39338173 | NEW textured white | 660 lm | 3,000 K | 75.00 |
| 39338183 | NEW textured black | 660 lm | 3,000 K | 75.00 |

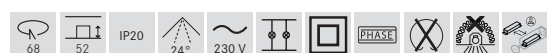

These items are subject to discount group 1.

ZONDRA LED recessed downlight set, direct / indirect, trailing-edge phase dimmable NEW

LED recessed downlight with 810 lm direct and 140 lm indirect light component. Light components can be dimmed simultaneously in the same ratio.

Lamp: LED, colour rendering: CRI > 80, power: 13 W, beam angle: 24°, material: aluminium / plastic

| Article no. | Colour | Lumin. flux | Colour temp. | Price in € |
|-------------|---|-------------|--------------|------------|
| 39339173 | NEW textured white | 950 lm | 3,000 K | 80.50 |
| 39339183 | NEW textured black | 950 lm | 3,000 K | 80.50 |

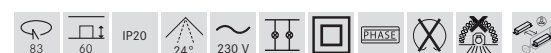

These items are subject to discount group 1.

NARES and NATUNA.

LED recessed downlight.

Minimalist with decorative sidelight.



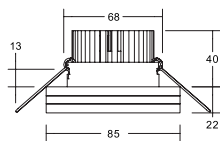

NARES LED recessed downlight with decorative side light, straight outer edge

NEW

Lamp: LED, version: Plug&Play, colour rendering: CRI > 80, power: 6 W, beam angle: 24°, material: aluminium / glass / plastic

You can find the corresponding 350 mA converter from page 202 onwards.

| Article no. | Colour | Lumin. flux | Colour temp. | Price in € |
|-------------|--------------------|-------------|--------------|------------|
| 12357173 | NEW textured white | 490 lm | 3,000 K | 36.80 |
| 12357183 | NEW textured black | 490 lm | 3,000 K | 36.80 |



These items are subject to discount group 1.

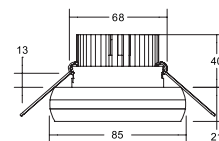

NATUNA LED recessed downlight with decorative side light, rounded outer edge

NEW

Lamp: LED, version: Plug&Play, colour rendering: CRI > 80, power: 6 W, beam angle: 24°, material: aluminium / glass / plastic

You can find the corresponding 350 mA converter from page 202 onwards.

| Article no. | Colour | Lumin. flux | Colour temp. | Price in € |
|-------------|--------------------|-------------|--------------|------------|
| 12358173 | NEW textured white | 490 lm | 3,000 K | 36.80 |
| 12358183 | NEW textured black | 490 lm | 3,000 K | 36.80 |

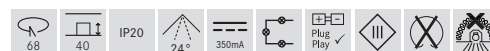

These items are subject to discount group 1.

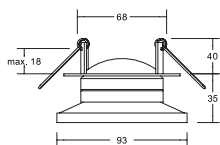

NAVARINO LED recessed spotlight, rotatable and swivelling

NEW

Lamp: LED, version: Plug&Play, colour rendering: CRI > 80, power: 6 W, beam angle: 24°, material: aluminium / PMMA

You can find the corresponding 350 mA converter from page 202 onwards.

| Article no. | Colour | Lumin. flux | Colour temp. | Price in € |
|-------------|--------------------|-------------|--------------|------------|
| 12356173 | NEW textured white | 510 lm | 3,000 K | 42.40 |
| 12356183 | NEW textured black | 510 lm | 3,000 K | 42.40 |



These items are subject to discount group 1.



MOON.

LED recessed or surface-mounted panel.

Colour rings can be changed magnetically.



Switchable colour temperature
3,000 K, 4,000 K or 6,000 K.



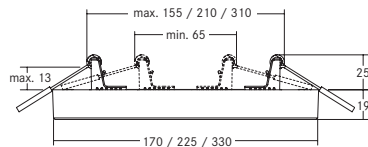

MOON LED recessed or surface-mounted panel, trailing-edge phase dimmable

Luminaire can be used both as a recessed and surface-mounted panel.

Lamp: LED, colour rendering: CRI > 80, beam angle: 110°, material: aluminium / plastic, includes converter for connection to 230 V mains voltage, trailing-edge phase dimmable, colour temperature adjustable on the housing.

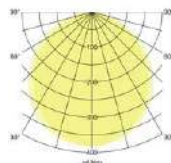

Service life L70/B50 at 25 °C: 25,000 hours

| Article no. | Colour | Version | Power | Lumin. flux | Colour temp. | Ceiling cut-out* | Installation depth* | Height | Diameter | System efficiency | Price in € |
|-------------|--------|---------|-------|-------------|-----------------------------|-------------------------|---------------------|--------|----------|-------------------|------------|
| 12205073 | white | Opal | 12 W | 1,020 lm | 3,000 K / 4,000 K / 6,000 K | min. 65 mm, max. 155 mm | max. 25 mm | 19 mm | 170 mm | 95 lm/W | 56.10 |
| 12206073 | white | Opal | 18 W | 1,685 lm | 3,000 K / 4,000 K / 6,000 K | min. 65 mm, max. 210 mm | max. 25 mm | 19 mm | 225 mm | 93 lm/W | 78.00 |
| 12207073 | white | Opal | 24 W | 2,345 lm | 3,000 K / 4,000 K / 6,000 K | min. 65 mm, max. 310 mm | max. 25 mm | 19 mm | 330 mm | 115 lm/W | 116.50 |

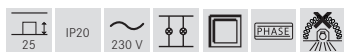

*for recessed installation

These items are subject to discount group 1.

Front rings: choice of colours (magnetic attachment)

| Article no. | Description | Price in € |
|-------------|--|------------|
| 81020502 | Front ring for 112205... chrome, round | 16.70 |
| 81020508 | Front ring for 12205... black, round | 16.70 |
| 81020515 | Front ring for 12205... matt nickel, round | 16.70 |
| 81020602 | Front ring for 12206... chrome, round | 19.20 |
| 81020608 | Front ring for 12206... black, round | 19.20 |
| 81020615 | Front ring for 12206... matt nickel, round | 19.20 |
| 81020702 | Front ring for 12207... chrome, round | 25.70 |
| 81020708 | Front ring for 12207... black, round | 25.70 |
| 81020715 | Front ring for 12207... matt nickel, round | 25.70 |

These items are subject to discount group 1.

Recessed installation: thanks to the integrated safety suspension, the luminaire is very easy to install. Installation can be carried out by one person, as the light is hooked onto the spring with the safety suspension. The round cut-out can be flexibly adjusted on the luminaire. This makes it possible to use an existing hole size of 65 to a maximum of 310 millimetres.

Surface mounting: the installation springs supplied are removed first. The luminaire can be easily attached to the ceiling using the mounting bracket.





SUNNY.

LED surface-mounted ceiling downlight.

Setting indirect accents.

SUNNY is an impressive “direct and indirect” luminaire with simple bayonet mounting, flexible light colour adjustment and an additional colour ring available for the indirect light component, which can be used to highlight building areas in colour.

The colour temperature can be set on site to 3,000 Kelvin, 4,000 Kelvin or 6,000 Kelvin. This makes the luminaire suitable for numerous applications, from private homes to public buildings.

Product advantages:

- 5-year Brumberg light guarantee.
- Standard indirect light component in white, as an accessory in amber, blue and red.
- Easy installation thanks to bayonet mounting and safety cable.
- Light can be removed thanks to separate mounting plate.
- Three sizes: 330 mm, 440 mm or 550 mm.
- Three light colours adjustable on site: 3,000 K, 4,000 K and 6,000 K.
- Also available as a pendant version (accessory: pendant set).
- Light colour adjustable on the switch side via bottom switch function.
- Trailing-edge phase or DALI dimmable (Size 440 mm and 550 mm).



To the product selection.



Installation: quick, tool-free installation thanks to separate mounting plate and modular system design. The housing of the light is screwed on without tools using a bayonet fixing.

Additional **colour ring sets** for indirect ambient lighting and additional **pendant set**.



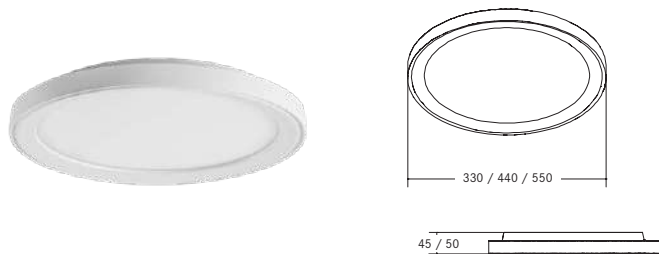

SUNNY LED surface-mounted ceiling downlight, trailing-edge phase dimmable NEW

Direct and indirect light emission.

Lamp: LED, colour rendering: CRI > 80, glare rating: UGR < 25, beam angle: 110°, material: aluminium / steel / polystyrene, includes converter for connection to 230 V mains voltage, trailing-edge phase dimmable and incl. adjustable colour temperature to 3,000 K, 4,000 K or 6,000 K (switchover on the housing or via wall-mounted switch via bottom switch function).

Optional accessories: colour ring set for the indirect light component in the colours red, blue and amber, as well as a pendant set 1,500 mm.

Service life L70/B50 at 25 °C: 50,000 hours

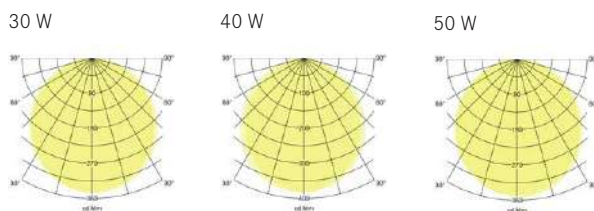

| Article no. | Colour | Power | Lumin. flux | Colour temp. | Installation height | Diameter | System efficiency | Price in € |
|-------------|--|-------|-------------|-----------------------------|---------------------|----------|-------------------|------------|
| 12208073 | white matt | 30 W | 2,700 lm | 3,000 K / 4,000 K / 6,000 K | 45 mm | 330 mm | 90 lm/W | 189.90 |
| 12208083 | NEW matt black | 30 W | 2,700 lm | 3,000 K / 4,000 K / 6,000 K | 45 mm | 330 mm | 90 lm/W | 189.90 |
| 12209073 | white matt | 40 W | 3,750 lm | 3,000 K / 4,000 K / 6,000 K | 50 mm | 440 mm | 94 lm/W | 259.90 |
| 12209083 | NEW matt black | 40 W | 3,750 lm | 3,000 K / 4,000 K / 6,000 K | 50 mm | 440 mm | 94 lm/W | 259.90 |
| 12214073 | NEW white matt | 50 W | 4,400 lm | 3,000 K / 4,000 K / 6,000 K | 50 mm | 550 mm | 88 lm/W | 299.90 |
| 12214083 | NEW matt black | 50 W | 4,400 lm | 3,000 K / 4,000 K / 6,000 K | 50 mm | 550 mm | 88 lm/W | 299.90 |



These items are subject to discount group 2.



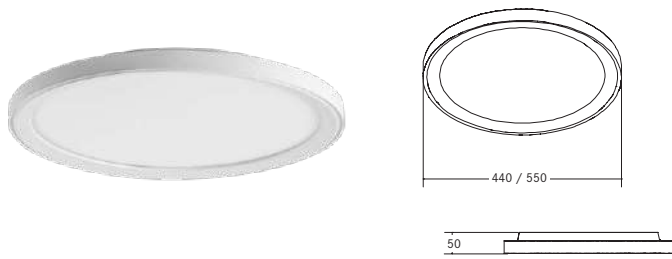

SUNNY LED surface-mounted ceiling downlight, DALI dimmable

NEW

Direct and indirect light emission.

Lamp: LED, colour rendering: CRI > 80, glare rating: UGR < 25, beam angle: 110°, material: aluminium / steel / polystyrene, includes converter for connection to 230 V mains voltage, DALI dimmable.

40 W

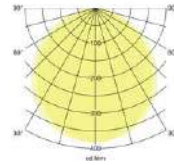

50 W

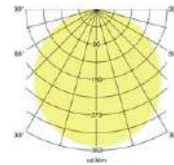

Optional accessories: colour ring set for the indirect light component in the colours red, blue and amber, as well as a pendant set 1,500 mm.

Service life L70/B50 at 25 °C: 50,000 hours

| Article no. | Colour | Power | Lumin. flux | Colour temp. | Control | Installation height | Diameter | System efficiency | Price in € |
|-------------|----------------|-------|-------------|--------------|---------|---------------------|----------|-------------------|------------|
| 12259073 | NEW white matt | 40 W | 3,750 lm | 3,000 K | DALI | 50 mm | 440 mm | 94 lm/W | 299.90 |
| 12259083 | NEW black matt | 40 W | 3,750 lm | 3,000 K | DALI | 50 mm | 440 mm | 94 lm/W | 299.90 |
| 12260073 | NEW white matt | 50 W | 4,250 lm | 3,000 K | DALI | 50 mm | 550 mm | 85 lm/W | 339.90 |
| 12260083 | NEW black matt | 50 W | 4,250 lm | 3,000 K | DALI | 50 mm | 550 mm | 85 lm/W | 339.90 |



These items are subject to discount group 2.

Additional **colour ring sets** for indirect ambient lighting and additional **pendant set**.



| Art. no. | Description | Price in € |
|----------|---|------------|
| 81020806 | Colour ring set for 12208 red | 14.00 |
| 81020808 | Colour ring set for 12208 blue | 14.00 |
| 81020809 | Colour ring set for 12208 amber | 14.00 |
| 81020906 | Colour ring set for 12209 / 12259 red | 19.00 |
| 81020908 | Colour ring set for 12209 / 12259 blue | 19.00 |
| 81020909 | Colour ring set for 12209 / 12259 amber | 19.00 |
| 81021406 | NEW Colour ring set for 12214 / 12260 red | 19.90 |
| 81021408 | NEW Colour ring set for 12214 / 12260 blue | 19.90 |
| 81021409 | NEW Colour ring set for 12214 / 12260 amber | 19.90 |

| | | | |
|----------|--|-------|-------|
| 81018070 | Pendant set for SUNNY LED | white | 39.90 |
| 81018080 | NEW surface-mounted downlight | black | 39.90 |
| | 12208... / 12209..., 12214... / 12259... / 12260... round, pendant length 1,500 mm | | |

These items are subject to discount group 2.

Installation: quick, tool-free installation thanks to separate mounting plate and modular system design. The housing of the light is screwed on without tools using a bayonet fixing.



PANAY.

LED ceiling-mounted luminaire.

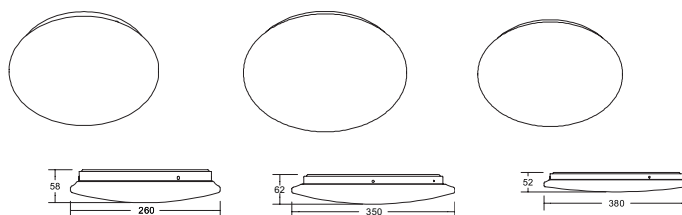

PANAY LED ceiling-mounted luminaire

NEW

Direct light emission. Three different colour temperatures can be set.

Lamp: LED, colour rendering: CRI > 80, beam angle: 120°, material: steel / plastic, includes converter for connection to 230 V mains voltage,

| Article no. | Colour | Power | Lumin. flux | Colour temp. | Control | Diameter | Equipment | Price in € |
|-------------|------------------|-------|-------------|-----------------------------|------------------------------|----------|------------------------------|------------|
| 12573073 | NEW glossy white | 12 W | 700 lm | 3,000 K / 4,000 K / 6,000 K | trailing-edge phase dimmable | Ø 260 mm | | 30.90 |
| 12574073 | NEW glossy white | 18 W | 1,880 lm | 3,000 K / 4,000 K / 6,000 K | trailing-edge phase dimmable | Ø 350 mm | | 37.90 |
| 12575073 | NEW glossy white | 24 W | 2,600 lm | 3,000 K / 4,000 K / 6,000 K | trailing-edge phase dimmable | Ø 380 mm | | 44.90 |
| 12576073 | NEW glossy white | 12 W | 700 lm | 3,000 K | switchable | Ø 260 mm | with microwave motion sensor | 32.90 |
| 12577073 | NEW glossy white | 18 W | 1,880 lm | 3,000 K | switchable | Ø 350 mm | with microwave motion sensor | 39.90 |
| 12578073 | NEW glossy white | 24 W | 2,600 lm | 3,000 K | switchable | Ø 380 mm | with microwave motion sensor | 46.90 |

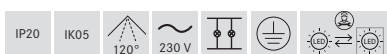

Luminous flux specification for light colour 3,000 K.
These items are subject to discount group 1.



BYAM.

LED ceiling-mounted luminaire.

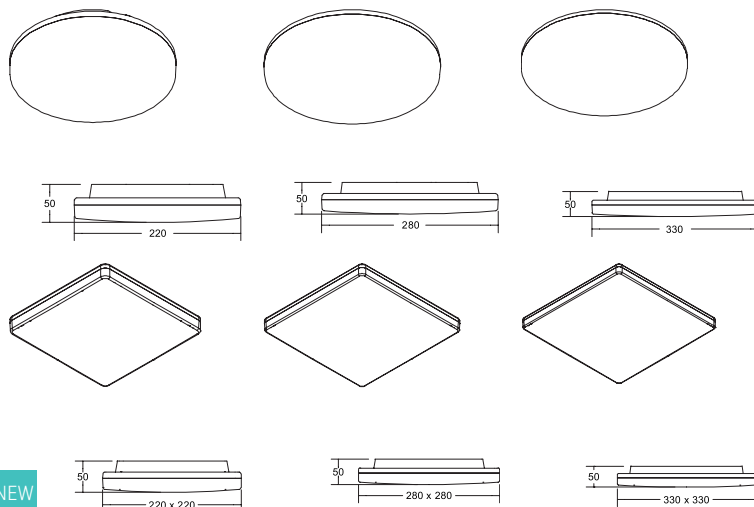

BYAM LED ceiling-mounted luminaire, 3CCT, Multipower, IP65, switchable

NEW

Direct light emission.

Lamp: LED, colour rendering: CRI > 80, beam angle: 120°, material: plastic, includes converter with power and colour temperature selection option for connection to 230 V mains voltage, switchable

| Article no. | Colour | Shape | Power (Multipower) | Lumin. flux | Colour temp. | Price in € |
|-------------|----------------|--------|--------------------|-------------|-----------------------------|------------|
| 12510073 | NEW matt white | round | 10 W / 15 W | 1,425 lm | 3,000 K / 4,000 K / 5,700 K | 53.60 |
| 12511073 | NEW matt white | round | 13 W / 18 W | 1,881 lm | 3,000 K / 4,000 K / 5,700 K | 68.00 |
| 12512073 | NEW matt white | round | 17 W / 24 W | 2,622 lm | 3,000 K / 4,000 K / 5,700 K | 85.60 |
| 12513073 | NEW matt white | square | 10 W / 15 W | 1,425 lm | 3,000 K / 4,000 K / 5,700 K | 55.20 |
| 12514073 | NEW matt white | square | 13 W / 18 W | 1,881 lm | 3,000 K / 4,000 K / 5,700 K | 74.50 |
| 12515073 | NEW matt white | square | 17 W / 24 W | 2,622 lm | 3,000 K / 4,000 K / 5,700 K | 89.90 |



Luminous flux specification for maximum output / light colour 3,000 K in each case. These items are subject to discount group 1.



PENCIL.

LED ceiling and wall-mounted luminaire.

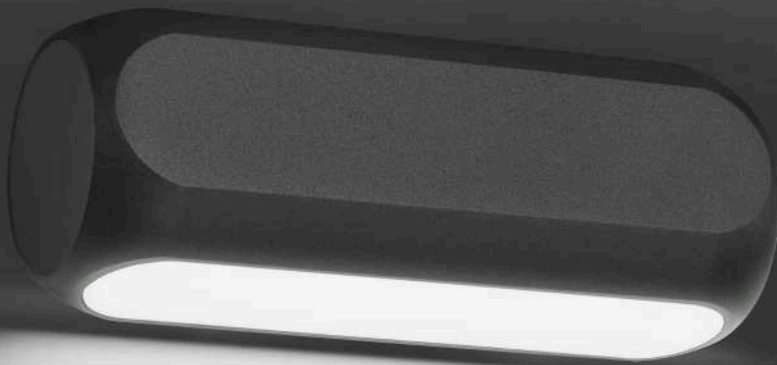
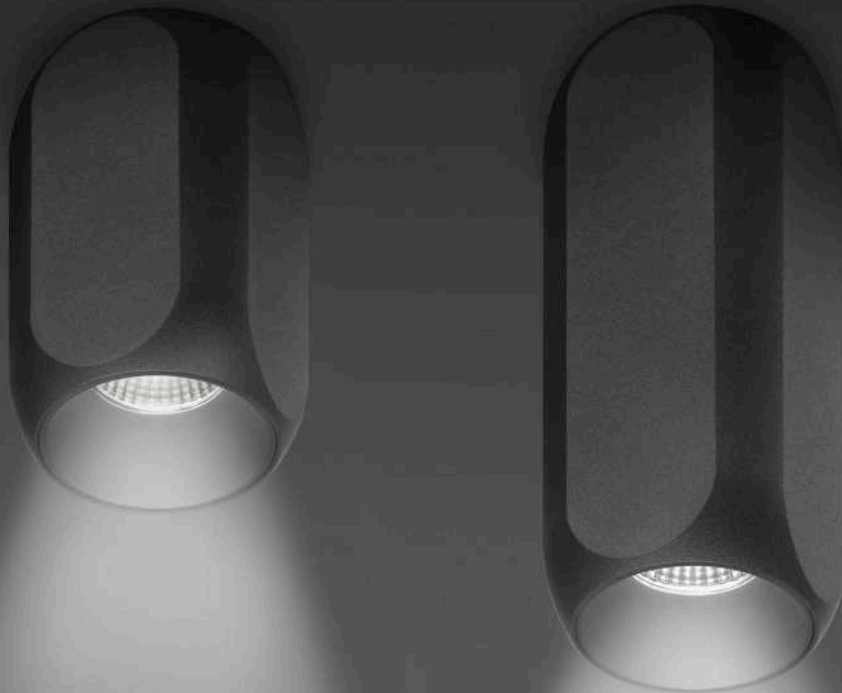

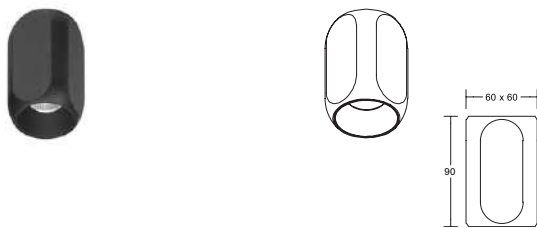

PENCIL MINI LED ceiling-mounted downlight, trailing-edge phase dimmable

NEW

Direct light emission.

Lamp: LED, colour rendering: CRI > 90, power: 4 W, beam angle: 40°, material: aluminium / PMMA

| Article no. | Colour | Lumin. flux | Colour temp. | Price in € |
|-------------|--------------------|-------------|--------------|------------|
| 12122173 | NEW textured white | 140 lm | 3,000 K | 154.90 |
| 12122183 | NEW textured black | 140 lm | 3,000 K | 154.90 |



These items are subject to discount group 1.

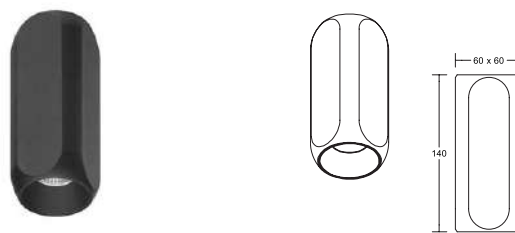

PENCIL MAXI LED ceiling-mounted downlight, trailing-edge phase dimmable

NEW

Direct light emission.

Lamp: LED, colour rendering: CRI > 90, power: 8 W, beam angle: 40°, material: aluminium / PMMA

| Article no. | Colour | Lumin. flux | Colour temp. | Price in € |
|-------------|--------------------|-------------|--------------|------------|
| 12123173 | NEW textured white | 267 lm | 3,000 K | 188.90 |
| 12123183 | NEW textured black | 267 lm | 3,000 K | 188.90 |

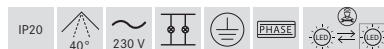

These items are subject to discount group 1.

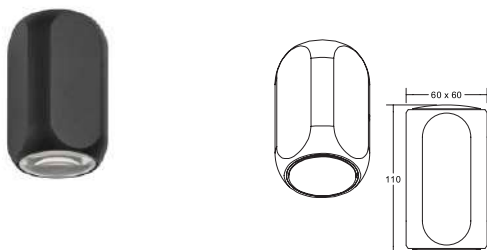

PENCILwall LED wall-mounted luminaire, direct / indirect, trailing-edge phase dimmable

NEW

Direct and indirect light emission.

Lamp: LED, colour rendering: CRI > 90, power: 2 x 4 W, beam angle: 70°, material: aluminium / glass

| Article no. | Colour | Lumin. flux | Colour temp. | Price in € |
|-------------|--------------------|-------------|--------------|------------|
| 10114173 | NEW textured white | 460 lm | 3,000 K | 222.90 |
| 10114183 | NEW textured black | 460 lm | 3,000 K | 222.90 |

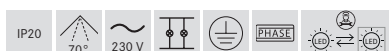

These items are subject to discount group 1.

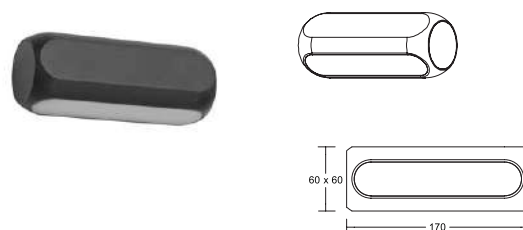

PENCILwall LED wall-mounted luminaire, direct, trailing-edge phase dimmable

NEW

Direct light emission.

Lamp: LED, colour rendering: CRI > 90, power: 8.5 W, beam angle: 110°, material: aluminium / acrylic

| Article no. | Colour | Lumin. flux | Colour temp. | Price in € |
|-------------|--------------------|-------------|--------------|------------|
| 10115173 | NEW textured white | 350 lm | 3,000 K | 259.90 |
| 10115183 | NEW textured black | 350 lm | 3,000 K | 259.90 |



These items are subject to discount group 1.

M1 module system

Consistent. Reduced. Simple.

The luminaire system for light on demand.



NOW
also as
wall luminaire



- Consistent planning options – as **recessed** and **surface-mounted luminaires** for all ceiling solutions and now also as **wall luminaires**.
- Reduced design language – simple and integrative.
- Lighting options – for all forms of ambient and accent lighting.
- Light colours for all applications – warm white, neutral white, cool white, TunableWhite, D2W.
- Simple switching – from on/off to trailing-edge phase to DALI.
- Installation – pluggable, simple installation up to through-wiring.

1

Configuration example: three simple steps to the solution.**Select the right housing shape, module holder and housing colour****Housing shape:**

angular wall luminaire, single-flame in textured white.

Module holder

Swivelling, flush module holder in textured white



+



+

Art. no. **45203170**
First article number

2

Select the right light.

DISC LED insert MR16, 6 W, with lens optics,

350 mA, CRI > 80

Colour temperature: 3,000 K

Luminous flux: 690 lm

Beam angle: 24°

Art. no. **12920243**
Second article number

3

Select the right converter.

LED round converter 350 mA, trailing-edge phase dimmable

Dimensions: D 51 x H 24 mm

Power: 4.9–7 W

Select the appropriate converter with the desired control, if applicable. Ensure that the power consumption corresponds to the number of LED modules selected.

Art. no. **17652000**
Third article number

1

+

2

+

3

= Fully configured luminaire, consisting of three article numbers.

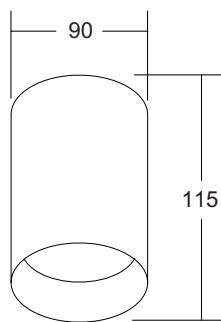

M1 Wall-mounted housing, round, recessed, with flush module holder, swivelling, without LED module

NEW

All Brumberg MR16 LED modules can be used for the M1 wall-mounted unit up to the maximum specified output.

The LED module, the converter or power supply unit and, if applicable, the control unit are not included in the delivery of the wall-mounted unit. We will be happy to help you select the right converter for the housing if you have any questions. Important: when using 24 V LED modules, the power supply unit and the control unit must always be installed on site outside the housing.

Lamp: for LED, version: without lamp holder, power: 8 W, material: aluminium, includes flush module holder, swivelling

Maximum output 8 W (on/off, phase, DALI). With an output of 8 W, the power supply unit and control unit must be installed outside the housing due to space constraints.

| Article no. | Colour | Price in € |
|-------------|-------------------------------------|------------|
| 45200170 | NEW textured white | 110.60 |
| 45200180 | NEW textured black | 110.60 |
| 45200550 | NEW textured white / textured black | 110.60 |
| 45200560 | NEW textured black / textured white | 110.60 |



These items are subject to discount group 1.



Incl. flush module holder, swivelling (20°)

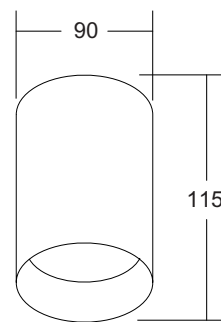

M1 Wall-mounted housing, round, recessed, with flush module holder, rigid, without LED module

NEW

All Brumberg MR16 LED modules can be used for the M1 wall-mounted unit up to the maximum specified output.

The LED module, the converter or power supply unit and, if applicable, the control unit are not included in the delivery of the wall-mounted unit. We will be happy to help you select the right converter for the housing if you have any questions. Important: when using 24 V LED modules, the power supply unit and the control unit must always be installed on site outside the housing.

Lamp: for LED, version: without lamp holder, power: 8 W, material: aluminium / glass, includes flush module holder, rigid

Maximum output 8 W (on/off, phase, DALI). With an output of 8 W, the power supply unit and control unit must be installed outside the housing due to space constraints.

| Article no. | Colour | Price in € |
|-------------|-------------------------------------|------------|
| 45201170 | NEW textured white | 110.60 |
| 45201180 | NEW textured black | 110.60 |
| 45201550 | NEW textured white / textured black | 110.60 |
| 45201560 | NEW textured black / textured white | 110.60 |



These items are subject to discount group 1.



Incl. flush module holder, rigid

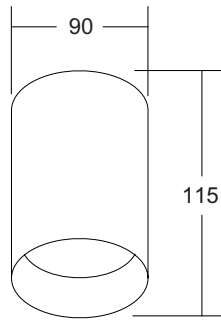

M1 Wall-mounted housing, round, recessed, with recessed module holder, swivelling, without LED module

NEW

All Brumberg MR16 LED modules can be used for the M1 wall-mounted unit up to the maximum specified output.

The LED module, the converter or power supply unit and, if applicable, the control unit are not included in the delivery of the wall-mounted unit. We will be happy to help you select the right converter for the housing if you have any questions. Important: when using 24 V LED modules, the power supply unit and the control unit must always be installed on site outside the housing.

Lamp: for LED, version: without lamp holder, power: 8 W, material: aluminium, includes recessed module holder, swivelling

Maximum output 8 W (on/off, phase, DALI). With an output of 8 W, the power supply unit and control unit must be installed outside the housing due to space constraints.

| Article no. | Colour | Price in € |
|-------------|--|------------|
| 45202170 | NEW textured white | 110.60 |
| 45202180 | NEW textured black | 110.60 |
| 45202550 | NEW textured white / textured black | 110.60 |
| 45202560 | NEW textured black / textured white | 110.60 |



These items are subject to discount group 1.



Incl. recessed module holder, swivelling (20°)

STEP 1



You can find here the new housings of the wall-mounted luminaires and can therefore select the first article number.

In the next steps, select the LED module and the appropriate converter.

Configure M1 online. Quick and easy.

The M1 modular system offers variable lighting properties and modern design across all applications. From the hotel or office to commercial or private rooms. From the application to the technology to the design in detail: it is good that the modules can be easily configured in three steps – depending on the room conditions.



Scan the QR code and start:

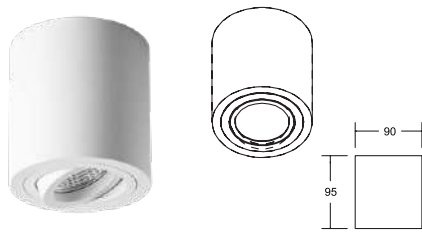

M1 Wall-mounted housing, round, flush, with flush module holder, swivelling, without LED module

NEW

All Brumberg MR16 LED modules can be used for the M1 wall-mounted unit up to the maximum specified output.

The LED module, the converter or power supply unit and, if applicable, the control unit are not included in the delivery of the wall-mounted unit. We will be happy to help you select the right converter for the housing if you have any questions. Important: when using 24 V LED modules, the power supply unit and the control unit must always be installed on site outside the housing.

Lamp: for LED, version: without lamp holder, power: 8 W, material: aluminium, includes flush module holder, swivelling

Maximum output 8 W (on/off, phase, DALI). With an output of 8 W, the power supply unit and control unit must be installed outside the housing due to space constraints.

| Article no. | Colour | Price in € |
|-------------|-------------------------------------|------------|
| 45206170 | NEW textured white | 101.10 |
| 45206180 | NEW textured black | 101.10 |
| 45206550 | NEW textured white / textured black | 101.10 |
| 45206560 | NEW textured black / textured white | 101.10 |



These items are subject to discount group 1.



Incl. flush module holder, swivelling (20°)

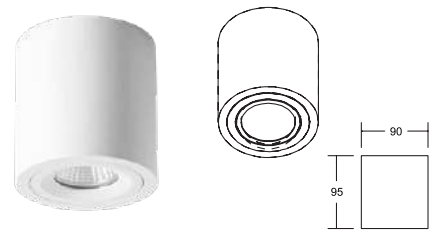

M1 Wall-mounted housing, round, flush, with flush module holder, rigid, without LED module

NEW

All Brumberg MR16 LED modules can be used for the M1 wall-mounted unit up to the maximum specified output.

The LED module, the converter or power supply unit and, if applicable, the control unit are not included in the delivery of the wall-mounted unit. We will be happy to help you select the right converter for the housing if you have any questions. Important: when using 24 V LED modules, the power supply unit and the control unit must always be installed on site outside the housing.

Lamp: for LED, version: without lamp holder, power: 8 W, material: aluminium / glass, includes flush module holder, rigid

Maximum output 8 W (on/off, phase, DALI). With an output of 8 W, the power supply unit and control unit must be installed outside the housing due to space constraints.

| Article no. | Colour | Price in € |
|-------------|-------------------------------------|------------|
| 45207170 | NEW textured white | 101.10 |
| 45207180 | NEW textured black | 101.10 |
| 45207550 | NEW textured white / textured black | 101.10 |
| 45207560 | NEW textured black / textured white | 101.10 |



These items are subject to discount group 1.



Incl. flush module holder, rigid

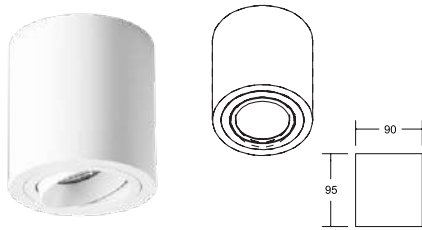

M1 Wall-mounted housing, round, flush, with recessed module holder, swivelling, without LED module

NEW

All Brumberg MR16 LED modules can be used for the M1 wall-mounted unit up to the maximum specified output.

The LED module, the converter or power supply unit and, if applicable, the control unit are not included in the delivery of the wall-mounted unit. We will be happy to help you select the right converter for the housing if you have any questions. Important: when using 24 V LED modules, the power supply unit and the control unit must always be installed on site outside the housing.

Lamp: for LED, version: without lamp holder, power: 8 W, material: aluminium, includes recessed module holder, swivelling

Maximum output 8 W (on/off, phase, DALI). With an output of 8 W, the power supply unit and control unit must be installed outside the housing due to space constraints.

| Article no. | Colour | Price in € |
|-------------|--|------------|
| 45208170 | NEW textured white | 101.10 |
| 45208180 | NEW textured black | 101.10 |
| 45208550 | NEW textured white / textured black | 101.10 |
| 45208560 | NEW textured black / textured white | 101.10 |



These items are subject to discount group 1.



Incl. recessed module holder, swivelling (20°)

STEP 1



You can find here the new housings of the wall-mounted luminaires and can therefore select the first article number.

In the next steps, select the LED module and the appropriate converter.

Configure M1 online. Quick and easy.

The M1 modular system offers variable lighting properties and modern design across all applications. From the hotel or office to commercial or private rooms. From the application to the technology to the design in detail: it is good that the modules can be easily configured in three steps – depending on the room conditions.



Scan the QR code and start:

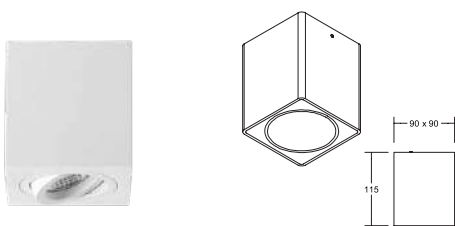

M1 Wall-mounted housing, square, flush, with flush module holder, swivelling, without LED module

NEW

All Brumberg MR16 LED modules can be used for the M1 wall-mounted unit up to the maximum specified output.

The LED module, the converter or power supply unit and, if applicable, the control unit are not included in the delivery of the wall-mounted unit. We will be happy to help you select the right converter for the housing if you have any questions. Important: when using 24 V LED modules, the power supply unit and the control unit must always be installed on site outside the housing.

Lamp: for LED, version: without lamp holder, power: 8 W, material: aluminium, includes flush module holder, swivelling

Maximum output 8 W (on/off, phase, DALI). With an output of 8 W, the power supply unit and control unit must be installed outside the housing due to space constraints.

| Article no. | Colour | Price in € |
|-------------|--|------------|
| 45210170 | NEW textured white | 101.10 |
| 45210180 | NEW textured black | 101.10 |
| 45210550 | NEW textured white / textured black | 101.10 |
| 45210560 | NEW textured black / textured white | 101.10 |



These items are subject to discount group 1.



Incl. flush module holder, swivelling (20°)

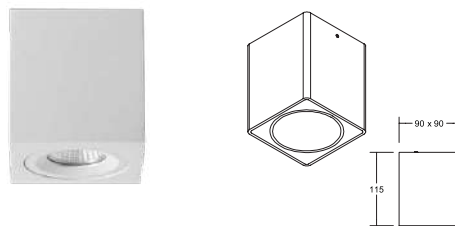

M1 Wall-mounted housing, square, flush, with flush module holder, rigid, without LED module

NEW

All Brumberg MR16 LED modules can be used for the M1 wall-mounted unit up to the maximum specified output.

The LED module, the converter or power supply unit and, if applicable, the control unit are not included in the delivery of the wall-mounted unit. We will be happy to help you select the right converter for the housing if you have any questions. Important: when using 24 V LED modules, the power supply unit and the control unit must always be installed on site outside the housing.

Lamp: for LED, version: without lamp holder, power: 8 W, material: aluminium / glass, includes flush module holder, rigid

Maximum output 8 W (on/off, phase, DALI). With an output of 8 W, the power supply unit and control unit must be installed outside the housing due to space constraints.

| Article no. | Colour | Price in € |
|-------------|--|------------|
| 45211170 | NEW textured white | 101.10 |
| 45211180 | NEW textured black | 101.10 |
| 45211550 | NEW textured white / textured black | 101.10 |
| 45211560 | NEW textured black / textured white | 101.10 |



These items are subject to discount group 1.



Incl. flush module holder, rigid

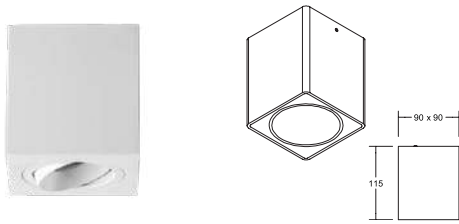

M1 Wall-mounted housing, square, flush, with recessed module holder, swivelling, without LED module

NEW

All Brumberg MR16 LED modules can be used for the M1 wall-mounted unit up to the maximum specified output.

The LED module, the converter or power supply unit and, if applicable, the control unit are not included in the delivery of the wall-mounted unit. We will be happy to help you select the right converter for the housing if you have any questions. Important: when using 24 V LED modules, the power supply unit and the control unit must always be installed on site outside the housing.

Lamp: for LED, version: without lamp holder, power: 8 W, material: aluminium, includes recessed module holder, swivelling

Maximum output 8 W (on/off, phase, DALI). With an output of 8 W, the power supply unit and control unit must be installed outside the housing due to space constraints.

| Article no. | Colour | Price in € |
|-------------|--|------------|
| 45212170 | NEW textured white | 101.10 |
| 45212180 | NEW textured black | 101.10 |
| 45212550 | NEW textured white / textured black | 101.10 |
| 45212560 | NEW textured black / textured white | 101.10 |



These items are subject to discount group 1.



Incl. recessed module holder, swivelling (20°)

STEP 1



You can find here the new housings of the wall-mounted luminaires and can therefore select the first article number.

In the next steps, select the LED module and the appropriate converter.

Configure M1 online. Quick and easy.

The M1 modular system offers variable lighting properties and modern design across all applications. From the hotel or office to commercial or private rooms. From the application to the technology to the design in detail: it is good that the modules can be easily configured in three steps – depending on the room conditions.



Scan the QR code and start:

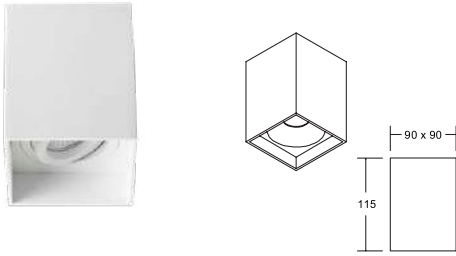

M1 Wall-mounted housing, square, recessed, with flush module holder, swivelling, without LED module

NEW

All Brumberg MR16 LED modules can be used for the M1 wall-mounted unit up to the maximum specified output.

The LED module, the converter or power supply unit and, if applicable, the control unit are not included in the delivery of the wall-mounted unit. We will be happy to help you select the right converter for the housing if you have any questions. Important: when using 24 V LED modules, the power supply unit and the control unit must always be installed on site outside the housing.

Lamp: for LED, version: without lamp holder, power: 8 W, material: aluminium, includes flush module holder, swivelling

Maximum output 8 W (on/off, phase, DALI). With an output of 8 W, the power supply unit and control unit must be installed outside the housing due to space constraints.

| Article no. | Colour | Price in € |
|-------------|--|------------|
| 45203170 | NEW textured white | 110.60 |
| 45203180 | NEW textured black | 110.60 |
| 45203550 | NEW textured white / textured black | 110.60 |
| 45203560 | NEW textured black / textured white | 110.60 |



These items are subject to discount group 1.



Incl. flush module holder, swivelling (20°)

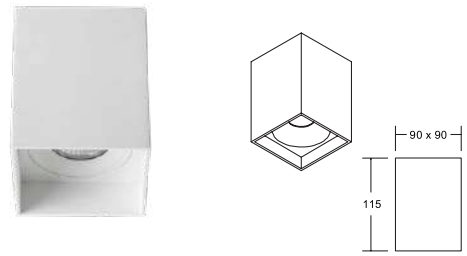

M1 Wall-mounted housing, square, recessed, with flush module holder, rigid, without LED module

NEW

All Brumberg MR16 LED modules can be used for the M1 wall-mounted unit up to the maximum specified output.

The LED module, the converter or power supply unit and, if applicable, the control unit are not included in the delivery of the wall-mounted unit. We will be happy to help you select the right converter for the housing if you have any questions. Important: when using 24 V LED modules, the power supply unit and the control unit must always be installed on site outside the housing.

Lamp: for LED, version: without lamp holder, power: 8 W, material: aluminium / glass, includes flush module holder, rigid

Maximum output 8 W (on/off, phase, DALI). With an output of 8 W, the power supply unit and control unit must be installed outside the housing due to space constraints.

| Article no. | Colour | Price in € |
|-------------|--|------------|
| 45204170 | NEW textured white | 110.60 |
| 45204180 | NEW textured black | 110.60 |
| 45204550 | NEW textured white / textured black | 110.60 |
| 45204560 | NEW textured black / textured white | 110.60 |



These items are subject to discount group 1.



Incl. flush module holder, rigid

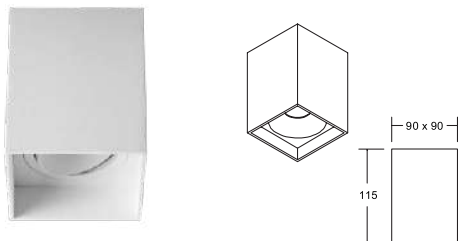

M1 Wall-mounted housing, square, recessed, with recessed module holder, swivelling, without LED module

NEW

All Brumberg MR16 LED modules can be used for the M1 wall-mounted unit up to the maximum specified output.

The LED module, the converter or power supply unit and, if applicable, the control unit are not included in the delivery of the wall-mounted unit. We will be happy to help you select the right converter for the housing if you have any questions. Important: when using 24 V LED modules, the power supply unit and the control unit must always be installed on site outside the housing.

Lamp: for LED, version: without lamp holder, power: 8 W, material: aluminium, includes recessed module holder, swivelling

Maximum output 8 W (on/off, phase, DALI). With an output of 8 W, the power supply unit and control unit must be installed outside the housing due to space constraints.

| Article no. | Colour | Price in € |
|-------------|--|------------|
| 45205170 | NEW textured white | 110.60 |
| 45205180 | NEW textured black | 110.60 |
| 45205550 | NEW textured white / textured black | 110.60 |
| 45205560 | NEW textured black / textured white | 110.60 |



These items are subject to discount group 1.



Incl. recessed module holder, swivelling (20°)

STEP 1



You can find here the new housings of the wall-mounted luminaires and can therefore select the first article number.

In the next steps, select the LED module and the appropriate converter.

Configure M1 online. Quick and easy.

The M1 modular system offers variable lighting properties and modern design across all applications. From the hotel or office to commercial or private rooms. From the application to the technology to the design in detail: it is good that the modules can be easily configured in three steps – depending on the room conditions.



Scan the QR code and start:

LED LIGHTING
FUNDING

BEG

Eligible
as a numbered set
incl. converter

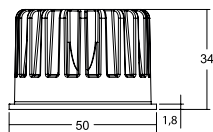

ROTI LED reflector insert MR16 with 3CCT, 6.3 W, 350 mA

Lamp: LED, version: Plug&Play, colour rendering: CRI > 80, power: 6.3 W, beam angle: 50°, material: aluminium / PMMA

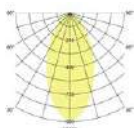

You can find the corresponding 350 mA converter from page 202 onwards.

| Article no. | Colour temperature | Power | Luminous flux | System efficiency | Price in € |
|---------------------|--------------------|-------|---------------|-------------------|------------|
| 12929503 NEW | 2,700 K | 6.3 W | 950 lm | 150 lm / W | 49.90 |
| | 3,000 K | 6.3 W | 971 lm | 154 lm / W | |
| | 4,000 K | 6.3 W | 1,023 lm | 162 lm / W | |



These items are subject to discount group 1.



Switchable converter

ROTI set includes LED insert and converter, switchable

NEW

Set incl. converter for 230V mains voltage, switchable, converter dimensions: L 68 x W 35 x H 21 mm

Lamp: LED, colour rendering: CRI > 80, beam angle: 50°, material: aluminium / PMMA / plastic

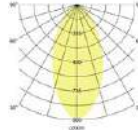

| Article no. | Colour temperature | System power | Luminous flux | System efficiency | Price in € |
|-------------|--------------------|--------------|---------------|-------------------|------------|
| 12981503 | 2,700 K | 7.8 W | 945 lm | 121 lm / W | 81.40 |
| | 3,000 K | 7.9 W | 972 lm | 123 lm / W | |
| | 4,000 K | 7.9 W | 1,031 lm | 130 lm / W | |



These items are subject to discount group 1.

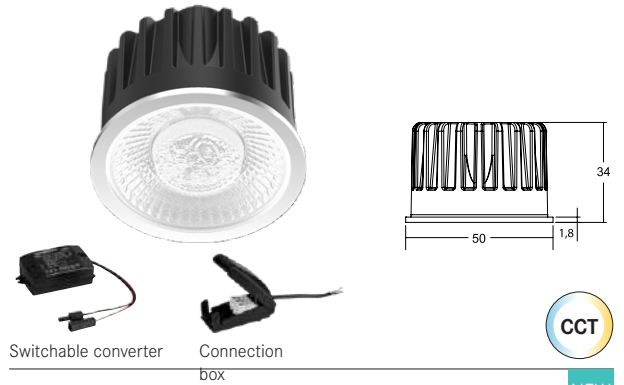

Switchable converter

Connection box

ROTI set includes LED insert, converter and connection box, switchable

NEW

Set includes converter for 230 V mains voltage, switchable, converter dimensions: L 68 x W 35 x H 21 mm

Lamp: LED, colour rendering: CRI > 80, beam angle: 50°, material: aluminium / PMMA / plastic includes 3-pole connection box

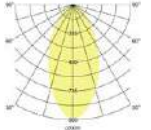

| Article no. | Colour temp. | System power | Luminous flux | System efficiency | Price in € |
|-------------|--------------|--------------|---------------|-------------------|------------|
| 12981503AB | 2,700 K | 7.8 W | 945 lm | 121 lm / W | 91.40 |
| | 3,000 K | 7.9 W | 972 lm | 123 lm / W | |
| | 4,000 K | 7.9 W | 1,031 lm | 130 lm / W | |



These items are subject to discount group 1.

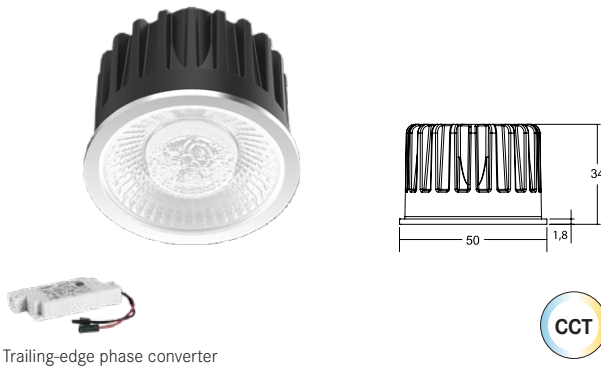

Trailing-edge phase converter

ROTI set includes LED insert and converter, trailing-edge phase dimmable

NEW

Set includes converter for 230 V mains voltage, trailing-edge phase dimmable, converter dimensions: L 110 x W 50 x H 19 mm

Lamp: LED, colour rendering: CRI > 80, beam angle: 50°, material: aluminium / PMMA / plastic

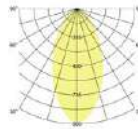

| Article no. | Colour temp. | System power | Luminous flux | System efficiency | Price in € |
|-------------|--------------|--------------|---------------|-------------------|------------|
| 12982503 | 2,700 K | 7.2 W | 899 lm | 124 lm / W | 86.50 |
| | 3,000 K | 7.5 W | 925 lm | 123 lm / W | |
| | 4,000 K | 7.4 W | 976 lm | 131 lm / W | |



These items are subject to discount group 1.

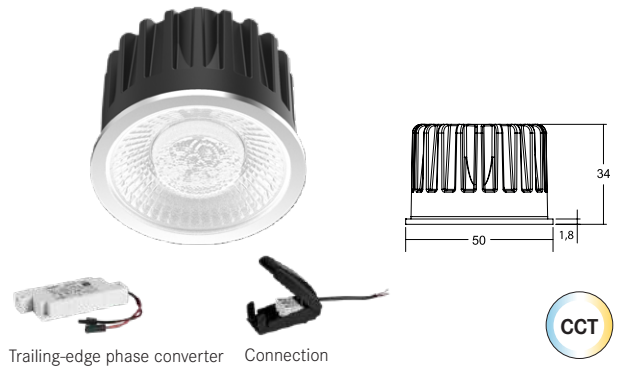

Trailing-edge phase converter

Connection box

ROTI set includes LED insert, converter and connection box, trailing-edge phase dimmable

NEW

Set includes converter for 230 V mains voltage, trailing-edge phase dimmable, converter dimensions: L 110 x W 50 x H 19 mm

Lamp: LED, colour rendering: CRI > 80, beam angle: 50°, material: aluminium / PMMA / plastic, includes 3-pole connection box

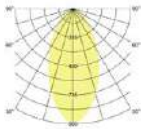

| Article no. | Colour temp. | System power | Luminous flux | System efficiency | Price in € |
|-------------|--------------|--------------|---------------|-------------------|------------|
| 12982503AB | 2,700 K | 7.2 W | 899 lm | 124 lm / W | 95.40 |
| | 3,000 K | 7.5 W | 925 lm | 123 lm / W | |
| | 4,000 K | 7.4 W | 976 lm | 131 lm / W | |



These items are subject to discount group 1.

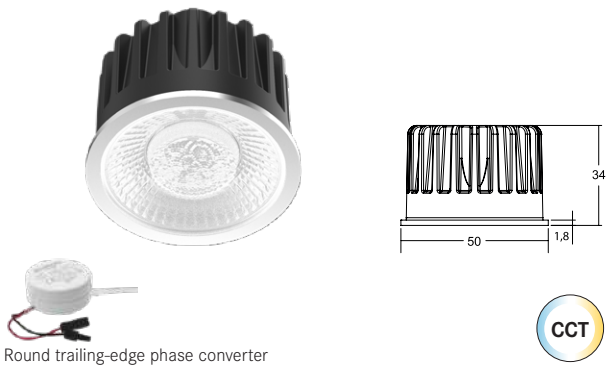

Round trailing-edge phase converter



ROTI set includes LED insert and round converter, trailing-edge phase dimmable

NEW

Set includes round converter for 230 V mains voltage, trailing-edge phase dimmable, converter dimensions: D 51 x H 24 mm

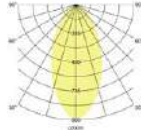

Lamp: LED, colour rendering: CRI > 80, beam angle: 50°, material: aluminium / PMMA / plastic

| Article no. | Colour temp. | System power | Luminous flux | System efficiency | Price in € |
|-------------|--------------|--------------|---------------|-------------------|------------|
| 12987503 | 2,700 K | 7.3 W | 924 lm | 126 lm / W | 102.80 |
| | 3,000 K | 7.5 W | 951 lm | 126 lm / W | |
| | 4,000 K | 7.5 W | 1,005 lm | 134 lm / W | |



These items are subject to discount group 1.

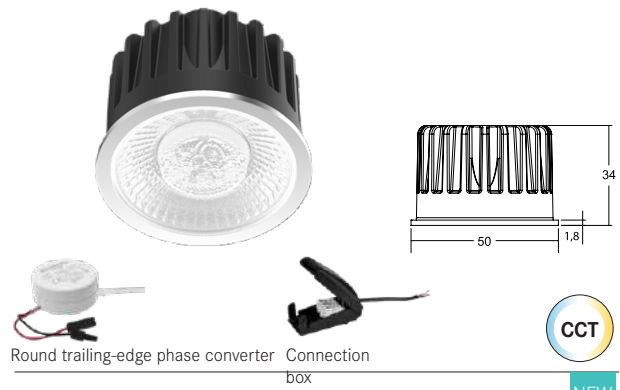

Round trailing-edge phase converter Connection box



ROTI set includes LED insert, round converter and connection box, trailing-edge phase dimmable

NEW

Set includes round converter for 230 V mains voltage, trailing-edge phase dimmable, converter dimensions: D 51 x H 24 mm

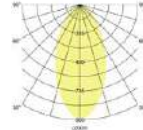

Lamp: LED, colour rendering: CRI > 80, beam angle: 50°, material: aluminium / PMMA / plastic includes 3-pole connection box

| Article no. | Colour temp. | System power | Luminous flux | System efficiency | Price in € |
|-------------|--------------|--------------|---------------|-------------------|------------|
| 12987503AB | 2,700 K | 7.3 W | 924 lm | 126 lm / W | 109.80 |
| | 3,000 K | 7.5 W | 951 lm | 126 lm / W | |
| | 4,000 K | 7.5 W | 1,005 lm | 134 lm / W | |



These items are subject to discount group 1.



DALI converter



ROTI set includes LED insert and converter, DALI dimmable

NEW

Set includes converter for 230 V mains voltage, DALI dimmable, converter dimensions: L 130 x W 42 x H 22 mm

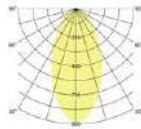

Lamp: LED, colour rendering: CRI > 80, beam angle: 50°, material: aluminium / PMMA / plastic

| Article no. | Colour temp. | System power | Luminous flux | System efficiency | Price in € |
|-------------|--------------|--------------|---------------|-------------------|------------|
| 12988503 | 2,700 K | 7.2 W | 898 lm | 124 lm / W | 131.10 |
| | 3,000 K | 7.3 W | 922 lm | 126 lm / W | |
| | 4,000 K | 7.3 W | 970 lm | 132 lm / W | |



These items are subject to discount group 1.

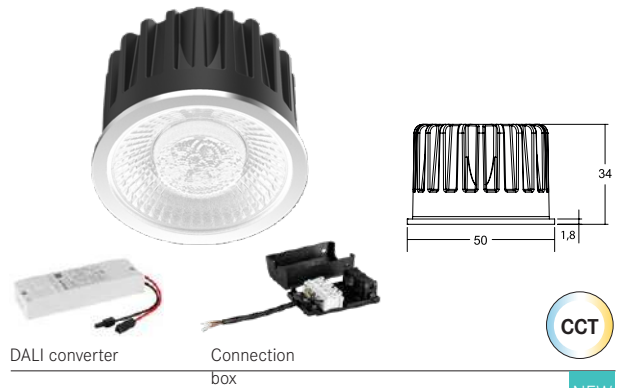

DALI converter Connection box



ROTI set includes LED insert, converter and connection box, DALI dimmable

NEW

Set includes converter for 230 V mains voltage, DALI dimmable, converter dimensions: L 130 x W 42 x H 22 mm

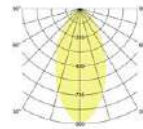

Lamp: LED, colour rendering: CRI > 80, beam angle: 50°, material: aluminium / PMMA / plastic includes 5-pole connection box

| Article no. | Colour temp. | System power | Luminous flux | System efficiency | Price in € |
|-------------|--------------|--------------|---------------|-------------------|------------|
| 12988503AB | 2,700 K | 7.2 W | 898 lm | 124 lm / W | 136.20 |
| | 3,000 K | 7.3 W | 922 lm | 126 lm / W | |
| | 4,000 K | 7.3 W | 970 lm | 132 lm / W | |



These items are subject to discount group 1.

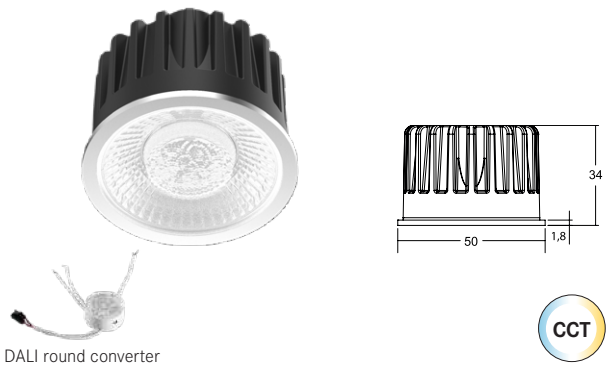

DALI round converter



NEW

ROTI set includes LED insert and round converter, DALI dimmable

Set includes round converter for 230 V mains voltage, DALI dimmable, converter dimensions: D 56 x H 25 mm

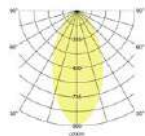

Lamp: LED, colour rendering: CRI > 80, beam angle: 50°, material: aluminium / PMMA / plastic

| Article no. | Colour temp. | System power | Luminous flux | System efficiency | Price in € |
|-------------|--------------|--------------|---------------|-------------------|------------|
| 12989503 | NEW 2,700 K | 6.9 W | 892 lm | 129 lm / W | 159.80 |
| | 3,000 K | 7.1 W | 918 lm | 129 lm / W | |
| | 4,000 K | 7.1 W | 971 lm | 136 lm / W | |



These items are subject to discount group 1.

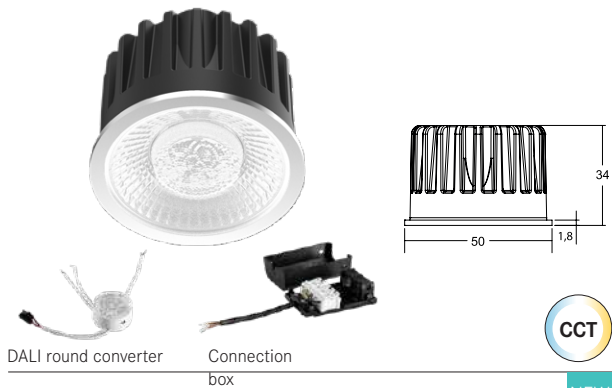

DALI round converter

Connection box



NEW

ROTI set includes LED insert, round converter and connection box, DALI dimmable

Set includes round converter for 230 V mains voltage, DALI dimmable, converter dimensions: D 56 x H 25 mm

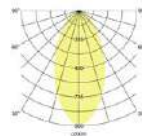

Lamp: LED, colour rendering: CRI > 80, beam angle: 50°, material: aluminium / PMMA / plastic includes 5-pole connection box

| Article no. | Colour temp. | System power | Luminous flux | System efficiency | Price in € |
|-------------|--------------|--------------|---------------|-------------------|------------|
| 12989503AB | NEW 2,700 K | 6.9 W | 892 lm | 129 lm / W | 167.80 |
| | 3,000 K | 7.1 W | 918 lm | 129 lm / W | |
| | 4,000 K | 7.1 W | 971 lm | 136 lm / W | |



These items are subject to discount group 1.

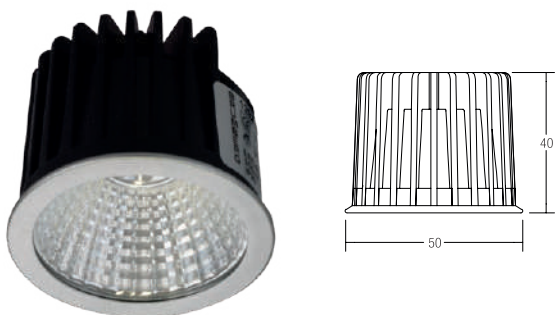

LED reflector insert MR16, 3 W, 350 mA

Lamp: LED, version: Plug&Play, colour rendering: CRI > 80, power: 3 W, beam angle: 38°, material: aluminium / glass

You can find the corresponding 350 mA converter from page 202 onwards.

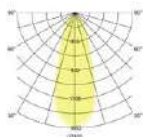

| Article no. | Colour temp. | Luminous flux | Beam angle | Price in € |
|-------------|--------------|---------------|------------|------------|
| 12925003 | 2700 K | 290 lm | 38° | 29.90 |
| 12926003 | 3000 K | 310 lm | 38° | 29.90 |
| 12925004 | 4000 K | 340 lm | 38° | 29.90 |



LED reflector insert MR16, 6 W, 350 mA

Lamp: LED, version: Plug&Play, colour rendering: CRI > 80, power: 6 W, material: aluminium / glass

You can find the corresponding 350 mA converter from page 202 onwards.

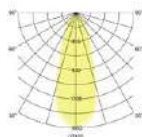

| Article no. | Colour temp. | Luminous flux | Beam angle | Price in € |
|-------------|--------------|---------------|------------|------------|
| 12923383 | 2700 K | 600 lm | 38° | 44.90 |
| 12923603 | 2700 K | 570 lm | 60° | 44.90 |
| 12924383 | 3000 K | 680 lm | 38° | 44.90 |
| 12924603 | 3000 K | 660 lm | 60° | 44.90 |
| 12924384 | 3500 K | 680 lm | 38° | 44.90 |
| 12924604 | 3500 K | 660 lm | 60° | 44.90 |
| 12923384 | 4000 K | 720 lm | 38° | 44.90 |
| 12923604 | 4000 K | 700 lm | 60° | 44.90 |



dim²warm

LED reflector insert MR16, 6 W, dim2warm, 350 mA

If the LED module is dimmed, the colour temperature is reduced.

Lamp: LED, version: Plug&Play, colour rendering: CRI > 80, power: 6 W, material: aluminium / glass

You can find the corresponding 350 mA converter from page 516 onwards.

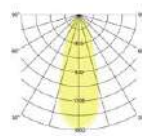

| Article no. | Colour temp. | Lumin. flux | Beam angle | Price in € |
|-------------|------------------------------|-------------|------------|------------|
| 12963383 | NEW 3,000 K - 1,800 K | 460 lm | 38° | 64.90 |
| 12963603 | NEW 3,000 K - 1,800 K | 460 lm | 60° | 64.90 |





LED reflector insert MR16, 12 W, 350 mA

Lamp: LED, version: Plug&Play, colour rendering: CRI > 80, power: 12 W, beam angle: 38°, material: aluminium / glass

You can find the corresponding 350 mA converter from page 202 onwards.

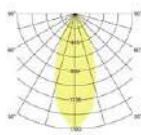

| Article no. | Colour temp. | Luminous flux | Beam angle | Price in € |
|-------------|--------------|---------------|------------|------------|
| 12953003 | 2700 K | 1,120 lm | 38° | 69.90 |
| 12954003 | 3000 K | 1,210 lm | 38° | 69.90 |
| 12954004 | 3500 K | 1,240 lm | 38° | 69.90 |
| 12953004 | 4000 K | 1,250 lm | 38° | 69.90 |



LED reflector insert MR16, 12 W, dim2warm, 350 mA

If the LED module is dimmed, the colour temperature is reduced.

Lamp: LED, version: Plug&Play, colour rendering: CRI > 90, power: 12 W, beam angle: 38°, material: aluminium / glass

You can find the corresponding 350 mA converter from page 202 onwards.

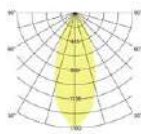

| Article no. | Colour temp. | Luminous flux | Beam angle | Price in € |
|-------------|-------------------|---------------|------------|------------|
| 12965003 | 3,000 K - 1,800 K | 930 lm | 38° | 99.90 |



DISC LED insert MR16, 6 W, with lens optics, 350 mA

Lamp: LED, version: Plug&Play, colour rendering: CRI > 80, power: 6 W, material: aluminium / plastic

You can find the corresponding 350 mA converter from page 202 onwards.

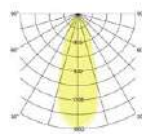

| Article no. | Colour temp. | Luminous flux | Beam angle | Price in € |
|-------------|--------------|---------------|------------|------------|
| 12920183 | 3000 K | 640 lm | 18° | 29.90 |
| 12920243 | 3000 K | 690 lm | 24° | 29.90 |
| 12920003 | 3000 K | 670 lm | 38° | 29.90 |
| 12920603 | 3000 K | 620 lm | 60° | 29.90 |
| 12920184 | 4000 K | 685 lm | 18° | 29.90 |
| 12920244 | 4000 K | 740 lm | 24° | 29.90 |
| 12920004 | 4000 K | 720 lm | 38° | 29.90 |
| 12920604 | 4000 K | 660 lm | 60° | 29.90 |



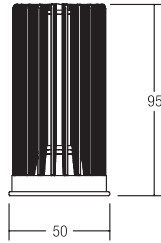

SunLike
Powered by

**LED reflector insert MR16,
12.5 W, SunLike, CRI > 97, 350 mA**

Lamp: LED, version: Plug&Play, **colour rendering: CRI > 97**, power: 12.5 W, beam angle: 38°, material: aluminium / plastic

You can find the corresponding 350 mA converter from page 202 onwards.

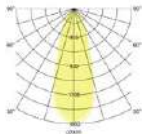

| Article no. | Colour temp. | Lumin. flux | Beam angle | Price in € |
|-------------|--------------|-------------|------------|------------|
| 12983003 | 3000 K | 920 lm | 38° | 119.90 |

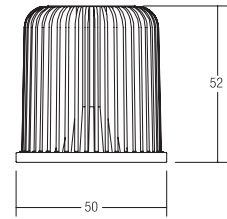

**LED reflector insert MR16,
8 W, 24 V DC**

Lamp: LED, colour rendering: CRI > 90, power: 8 W, beam angle: 60°, material: aluminium / glass

You can find the corresponding 24 V power supply units from page 202 onwards.

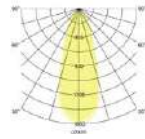

| Article no. | Colour temp. | Lumin. flux | Beam angle | Price in € |
|-------------|--------------|-------------|------------|------------|
| 12823003 | 2850 K | 900 lm | 60° | 109.90 |

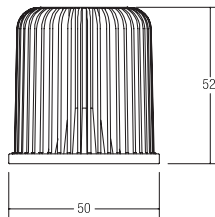

tunable
WHITE

**LED reflector insert MR16,
8 W, TunableWhite, 24 V DC**

Connection cable: 3-wire, control: negative, common anode (C.A.)

Lamp: LED, colour rendering: CRI > 90 (CW + WW), power/colour temperature approx. 4W (WW), 4W (CW), 8W (WW+CW) beam angle: 60°, material: aluminium / glass

You can find the corresponding 24 V power supply units from page 262 onwards and the corresponding control units from page 268 onwards.

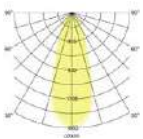

| Article no. | Colour temp. | Lumin. flux | Beam angle | Price in € |
|-------------|-----------------|-------------|------------|------------|
| 12843004 | 2000 K - 6500 K | 700 lm* | 60° | 109.90 |



*Luminous flux: 318 lm at 2,000 K, 374 lm at 4,000 K, 415 lm at 6,500 K

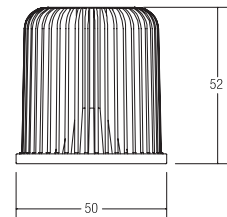

dim4colour

**LED reflector insert MR16, 8 W,
dim4colour (RGB+WW), 24 V DC**

RGB+WW module, connection cable: 5-wire, Control: negative, common anode (C.A.)

Lamp: LED, colour rendering: CRI > 90, power: 8 W, beam angle: 60°, luminous flux: RGB (combined) 165 lm / WW (2,850 K) 235 lm, material: aluminium / plastic

You can find the corresponding 24 V power supply units from page 262 onwards and the corresponding control units from page 268 onwards.

| Article no. | Colour temp. | Beam angle | Price in € |
|-------------|--------------|------------|------------|
| 18438002 | RGB+WW | 60° | 169.90 |

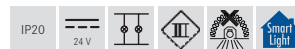



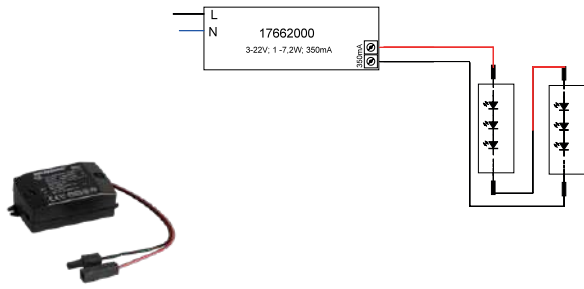

LED converter 350 mA, switchable

This converter is protected against overvoltage and short circuit as well as thermal and electrical overload by fuses. The input and output terminals are suitable for cables with a cross-section of up to 1.5 mm².

Dimensions: L 68 x W 35 x H 21 mm, input voltage: AC: 220-240 V, switching type on secondary side: series circuit, control: switchable, ambient temperature (ta): -20 °C to +50 °C, measuring point (tc): max. +75 °C, material: plastic, includes Plug&Play version with 110 mm P&P output cable

| Article no. | Power | Assembly | Power | Price in € |
|-------------|-------|----------------------------|---------|------------|
| 17662000 | 350mA | Plug&Play | 1-7.2 W | 31.50 |
| 17662010 | 350mA | without | 1-7.2 W | 28.00 |
| 17662020 | 350mA | Plug&Play + connection box | 1-7.2 W | 41.50 |

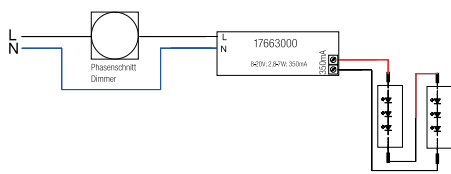

LED converter 350 mA, trailing-edge phase dimmable

This converter is protected against overvoltage and short circuit as well as thermal and electrical overload by fuses. The input and output terminals are suitable for cables with a cross-section of up to 1.5 mm².

Dimensions: L 110 x W 50 x H 19 mm, input voltage: AC: 198-264 V, switching type on secondary side: series circuit, control: trailing-edge phase, ambient temperature (ta): -20 °C to +50 °C, measuring point (tc): max. +80 °C, material: plastic, includes Plug&Play version with 110 mm P&P output cable

| Article no. | Power | Assembly | Power | Price in € |
|-------------|-------|----------------------------|---------|------------|
| 17663000 | 350mA | Plug&Play | 2.8-7 W | 36.60 |
| 17663010 | 350mA | without | 2.8-7 W | 34.30 |
| 17663020 | 350mA | Plug&Play + connection box | 2.8-7 W | 45.50 |

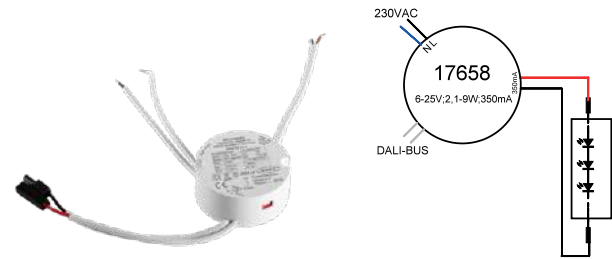

LED round converter 350 mA, DALI dimmable (digital)

This converter is protected against overvoltage and short circuit as well as thermal and electrical overload by fuses.

Dimensions: D x H: 56 x 25 mm, input voltage: AC: 220-240 V, control: DALI-2, ambient temperature (ta): -20 °C to +45 °C, measuring point (tc): max. +85 °C, material: plastic, includes Plug&Play version with 110 mm P&P output cable

| Article no. | Power | Assembly | Power | Price in € |
|-------------|------------------|----------------------------|---------|------------|
| 17658000 | NEW 350mA | Plug&Play | 2.1-9 W | 109.90 |
| 17658010 | NEW 350mA | without | 2.1-9 W | 108.90 |
| 17658020 | NEW 350mA | Plug&Play + connection box | 2.1-9 W | 117.90 |



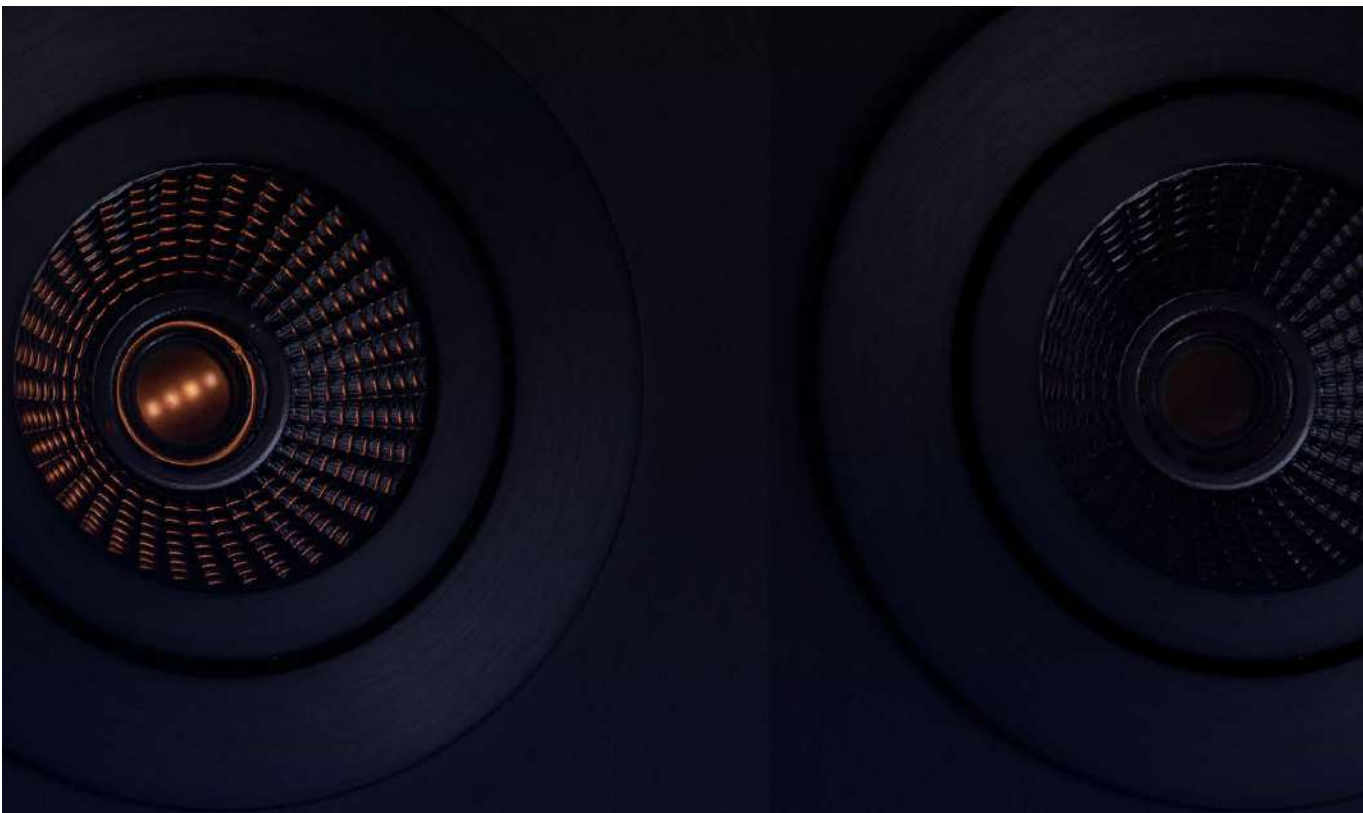

NO
GLOW

100%
OFF

Are you familiar with this problem?
Not with us!

Our guarantee: no afterglow of the LEDs.

It is undesirable and unacceptable to have the LED luminaires remain dimly lit when they are switched off.

Our new LED converter prevents this from happening. This reduces troubleshooting and installation work and offers optimum operational reliability.

The converter is available in three versions and is also already integrated **in the BB sets**.



LED converter 350 mA, DALI dimmable (digital)

This converter is protected against overvoltage and short circuit as well as electrical overload by fuses. The input and output terminals are suitable for cables with a cross-section of 0.75-1.5 mm².

Dimensions: L 130 x W 43 x H 22 mm, input voltage: AC: 220-240 V, DC: 186-250 V, control: DALI-2, ambient temperature (ta): -20 °C to +50 °C, measuring point (tc): max. +70 °C, material: plastic, includes Plug&Play version with 110 mm P&P output cable

| Article no. | Power | Assembly | Power | Price in € |
|-------------|-------|----------------------------|---------|------------|
| 17684000 | 350mA | Plug&Play | 2.8-7 W | 81.20 |
| 17684010 | 350mA | without | 2.8-7 W | 75.90 |
| 17684020 | 350mA | Plug&Play + connection box | 2.8-7 W | 86.30 |



ROSS.

LED battery-powered table lamp.





ROSS LED battery-powered table lamp, IP54, dimmable

NEW

Lamp: LED, colour rendering: CRI > 80, power: 4.8 W, luminous flux: 150 lm, material: die-cast aluminium / plastic, includes USB-C charging cable

- 1 x 3,600 mA lithium battery.
- Charging time: 4.5 hrs.
- Working time: 7.5 hrs.
- Touch dimming function

| Article no. | Colour | Lumin. flux | Colour temp. | Price in € |
|-------------|---|-------------|--------------|------------|
| 65401183 | NEW textured black sim. RAL 9005 | 150 lm | 3,000 K | 89.90 |
| 65401003PI | NEW textured pink sim. RAL 3015 | 150 lm | 3,000 K | 89.90 |
| 65401123 | NEW textured rust brown | 150 lm | 3,000 K | 89.90 |
| 65401003SG | NEW textured sage green sim. RAL 5635 | 150 lm | 3,000 K | 89.90 |
| 65401003BL | NEW textured blue sim. RAL 7468 | 150 lm | 3,000 K | 89.90 |
| 65401003GE | NEW textured yellow sim. RAL 1012 | 150 lm | 3,000 K | 89.90 |
| 65401003OR | NEW textured orange sim. RAL 2010 | 150 lm | 3,000 K | 89.90 |
| 65401003SB | NEW textured sand beige sim. RAL 1039 | 150 lm | 3,000 K | 89.90 |



These items are subject to discount group 1.



REIRO LED battery-powered table lamp, IP54, dimmable

NEW

Lamp: LED, colour rendering: CRI > 80, power: 4.8 W, luminous flux: 150 lm, material: aluminium / glass / plastic, includes USB-C charging cable

- 1 x 3,600 mA lithium battery.
- Charging time: 4.5 hours
- Working time: 7.5 hrs.
- Touch dimming function

| Article no. | Colour | Lumin. flux | Colour temp. | Price in € |
|-------------|---|-------------|--------------|------------|
| 65411183 | NEW textured black sim. RAL 9005 | 150 lm | 3,000 K | 99.90 |
| 65411003PI | NEW textured pink sim. RAL 3015 | 150 lm | 3,000 K | 99.90 |
| 65411123 | NEW textured rust brown | 150 lm | 3,000 K | 99.90 |
| 65411003SB | NEW textured sand beige sim. RAL 1039 | 150 lm | 3,000 K | 99.90 |



These items are subject to discount group 1.



PRESERVING WHAT ALREADY EXISTS, CREATING SOMETHING NEW.



DETACHED HOUSE RENOVATION AND EXTENSION.

Engelshove Bau GmbH stands for well thought-out construction planning from the first draft to the completion of the house. The architects rely on high-quality materials, building materials and products. Together with selected partners, they primarily design modern residential buildings. To achieve this, they develop customised detailed solutions for interiors and exterior design. Brumberg products were a central component of the concept for the renovation and extension of a detached house in Coesfeld. In this interview, architect Anja Engelshove tells us what the special tasks were for this particular project, why lighting always plays an important role for her and how she handles her various construction projects.



Anja Engelshove | Architect



Engelshove
Architektur | Ing.-Büro | Bauunternehmen

Brumberg: Mrs Engelshove, thank you very much for taking the time to talk to us. In the construction project in Coesfeld, you added a modern extension to an existing building. What was your central task in this project?

Anja Engelshove: Our main task was to preserve the basic structure of the existing residential building.

As this was the client's parents' house, it was naturally an emotional project that required us to show particular sensitivity.

Brumberg: It must have made things more difficult. How did you deal with it?

Anja Engelshove: Such tasks have been part of our daily business for over two decades. Nevertheless, all clients are different and every project is different. We always treat our customers' wishes with the necessary seriousness, provide advice when needed and try to put ourselves in our clients' position. In this project, it quickly became clear that the old family home and its character should be fundamentally preserved.

Brumberg: What were your biggest challenges?

Anja Engelshove: The biggest challenge was definitely to create separate areas for parents and children. We wanted to create a play and living paradise for the children with a modern extension.

Brumberg: How did you manage that?

Anja Engelshove: The passageway between the new building and the client's old parental home created a bridge between the old and the new. In the new building, the children have their own area with separate access to the garden and the newly created south-facing inner courtyard. On sunny days, life moves outside and everyone gets together to eat and play. Inside, we opened up the building, removed walls and developed a new spatial concept. For example, there is plenty of space for everyday life in the open-plan living and dining room with adjoining kitchen. The whole family can come together here to cook, eat, learn, watch TV, play and simply feel at home.

Brumberg: They appeal to the open-plan living concept. What role does lighting play in the development of such a concept?

Anja Engelshove: In open-plan living concepts, the lighting should enable variable room utilisation. This means that it has an accentuating effect indoors, but also provides the necessary ambient brightness. I like to organise rooms into zones, but I orientate myself less on grids than on structural elements such as windows. As early as the design phase, we pay attention to the incidence of light and look at how the daylight flows. We can use lighting to direct the line of sight of a building's residents and visitors. We attach great importance to the uniformity of the luminaires in terms of design, housing colour and colour temperature. Ideally, lighting should be dimmable so that it can be adjusted to suit different activities.

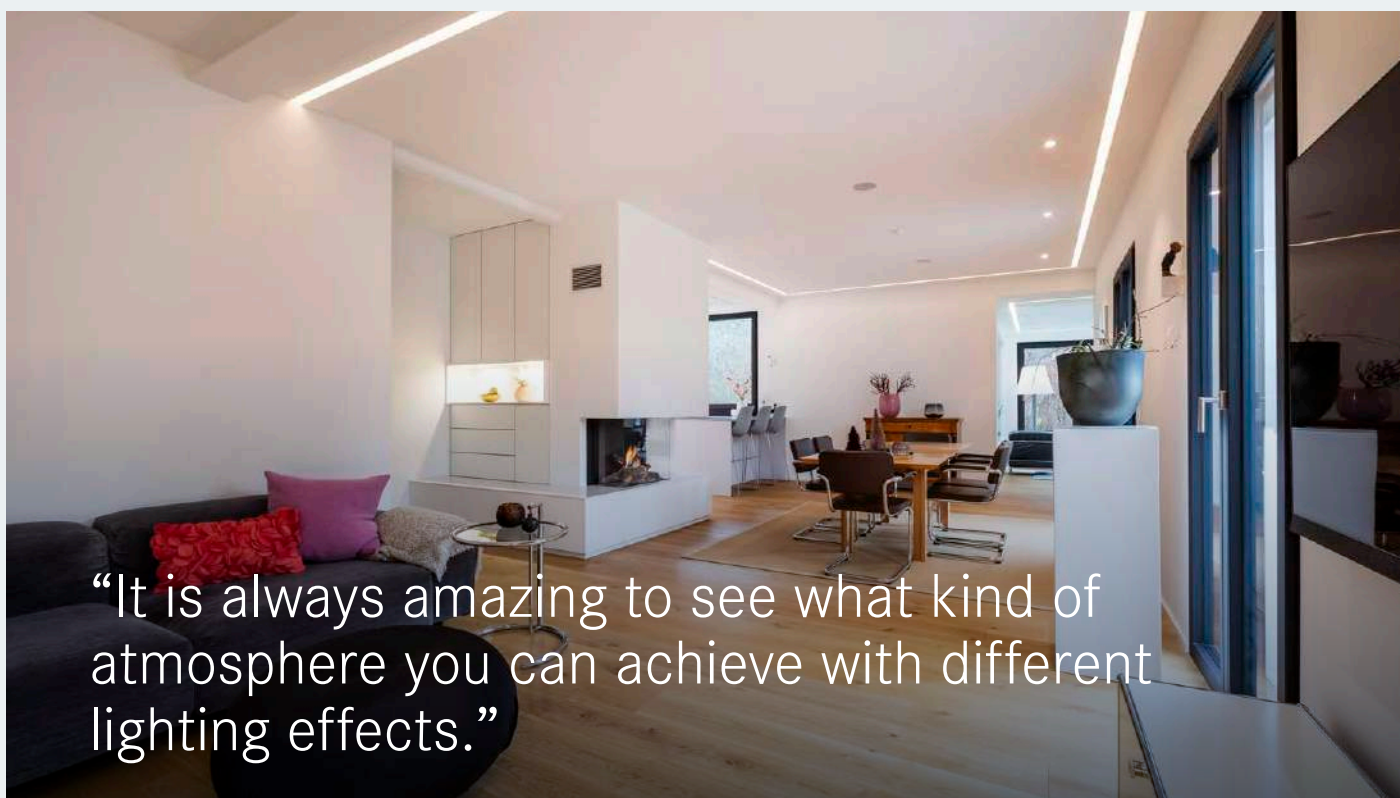

“It is always amazing to see what kind of atmosphere you can achieve with different lighting effects.”

Brumberg: How exactly do you proceed to implement your lighting concepts?

Anja Engelshove: We deliberately work with accentuations using special highlights such as light niches or light lines embedded in the ceiling. The room concept is always based on the requirements of the architecture and, of course, the client. Different lighting scenarios are required in many rooms, depending on the time of day and activity. We therefore develop lighting concepts that fulfil these requirements, taking into account the many demands that people place on their homes. Ultimately, the aim is to convey a feeling of cosiness, security and safety. Brumberg is an important partner for us in this regard, as the products are coordinated with each other and fulfil precisely this functionality in private construction.

Brumberg: What specific lighting requirements did you have for this project?

Anja Engelshove: The light source should be subordinate to the emotional and practical significance of its area of application, as the lighting effect comes first. For this project, we worked primarily with recessed spotlights and light lines from Brumberg, which complement each other perfectly. Naturally, the spotlights and LED strips had to match each other in terms of light colour. We also usually work with smart home solutions, so the lighting here should also enable various scenarios depending on the time of day.

Brumberg: Why did you choose Brumberg for this project?

Anja Engelshove: Because I am convinced of the quality of the products. We have been working with Brumberg for several years now. We are impressed every time by the technical versatility, the material quality and the lighting result. Even though I would like to see more decorative luminaires for dining areas in some places that I can use as eye-catchers in planning, Brumberg offers luminaires for various applications that are uniform in design, shape, colour and light quality. This allows me to use similar products for different areas to create a uniform picture. The LED strips from Brumberg also offer the necessary flexibility for light lines and accent lighting.

Brumberg: At what point in the project planning do you deal with the lighting?

Anja Engelshove: We already take the lighting into account in the first draft in coordination with an initial interior design. We also already set accents. For example, with base lighting for fireplaces or bathtubs. This allows us to show customers what is possible and how they can make their homes cosy and contemporary. The lighting often also results from the architecture, as certain structural elements can determine the position of the luminaires. Once the floor plan is finalised, we get down to the details and start with the electrical and light-

ing planning. We take a holistic approach, which means that we harmonise all components of the house, from the entrance to the storeroom and back out into the garden.

Brumberg: How do you conceptually deal with the individual rooms and requirements?

Anja Engelshove: The light must always match the overall concept, whether indoors or outdoors. It is always amazing to see what kind of atmosphere you can achieve with different lighting effects. The requirements of our customers are decisive here. In an open-plan building, as in this project, it is necessary to create zones that are also marked by the lighting. The lighting should be as independent and variably controllable as possible and be able to be adjusted to the time of day and the occupants' activities. Moreover, certain rooms have different functions. For example, the kitchen is a multi-functional room where you spend a lot of time. The lighting must ensure functionality but also create atmosphere.

Brumberg: Last question: what does the project process look like for you, from planning to completion?

Anja Engelshove: It is always important for us to get to know the clients at the start of a project. Our discussions are not exclusively about the construction project. In order for us to fulfil our customers' requirements and wishes, we also need to know how they think and feel, what emotions they associate with the building project and what they would like to see in the course of the project. We also need to familiarise ourselves with the nature of the property in order to determine what is possible. Once we know all the parameters, we move on to the planning phase. We develop our designs in close consultation with the customer, which we then deepen and visualise in detail during the preparation phase. This also includes planning the building application as well as commissioning and coordinating the various contractors, selecting the materials and making a precise calculation. When everything seems right, it's time to build. We take care of the construction management so that the clients can sit back, relax and look forward to their new home.

Brumberg: Thank you very much for this interview. ■

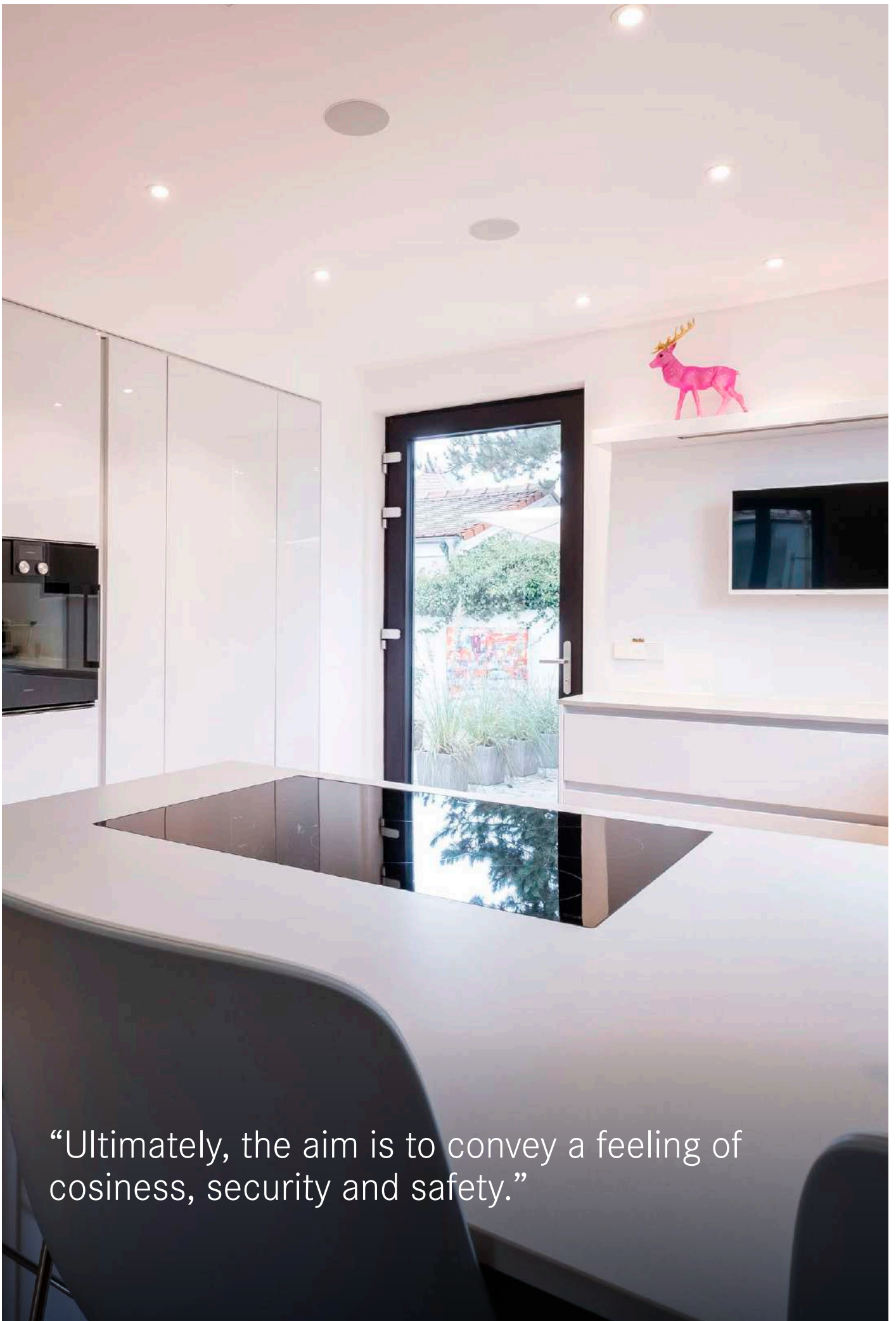

“Ultimately, the aim is to convey a feeling of cosiness, security and safety.”

06

Industrial luminaires.

Reliable lighting for
greater safety.



HUMID ONE PRO.

LED moisture-proof luminaire, DALI.

Made for a long service life.
Solid, smart and safe.

LED LIGHTING
FUNDING

BEG



Fast installation.
Sturdy, impact-proof housing
made of recycled polycarbonate.
Multi-lumen via DIP switch.
Versions incl. **emergency light**
function.



NEW: NOW
DALI dimmable

Further technical data for the HUMID ONE LED moisture-proof luminaires can be found on our website.

Product advantages:

- 5-year Brumberg guarantee
(Registration on the Brumberg website in the Services section).
- BEG LED lighting funding.
- D-mark.
- Long service life: L80B50 > 50,000 hours at +25 °C.
- High efficiency.
- Planning security thanks to the enclosed accessories.
- Quick installation via standard through-wiring.

IP65

IP65: the luminaire has complete protection against accidental contact. Dust cannot penetrate and it is protected against water jets in any direction.



New technology, better price!

HUMID ONE PRO LED moisture-proof bulkhead luminaire, DALI dimmable

NEW

Lamp: LED, colour rendering: CRI > 80, material: polycarbonate / stainless steel, includes converter for connection to 230 V mains voltage, through-wiring as standard, DALI-2 dimmable.

Delivery incl. mounting accessory set consisting of:

- 4 x locking screws for clip holder
- 2 x locking screws and nuts for universal mounting bracket
- 4 x mounting screws and dowels
- 2 x universal mounting brackets for wall, ceiling or pendant mounting (brackets required for hanging in the mounting bracket included in the delivery)
- 1 x IP65 cable gland PG13.5 (cable diameter Ø 6 - 12 mm)

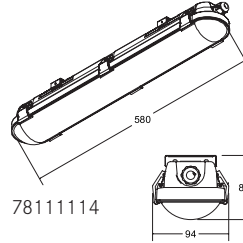

78111114

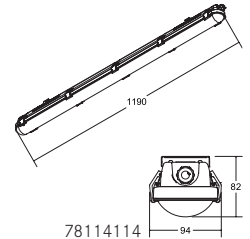

78114114

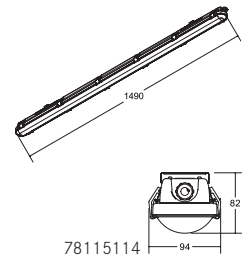

78115114

| Article no. | | Lumin. flux | Power | Colour temp. | Control | Length | Width | Price in € |
|-------------|-----|-------------|-------|--------------|---------------|----------|-------|------------|
| 78111114 | NEW | 2,500 lm | 20 W | 4,000 K | DALI-2 | 580 mm | 94 mm | 79.90 |
| 78114114 | NEW | 4,900 lm | 38 W | 4,000 K | DALI-2 | 1,190 mm | 94 mm | 89.90 |
| 78115114 | NEW | 7,100 lm | 55 W | 4,000 K | DALI-2 | 1,490 mm | 94 mm | 99.90 |

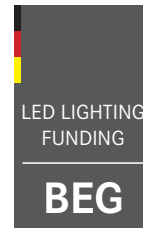

These items are subject to discount group 2.

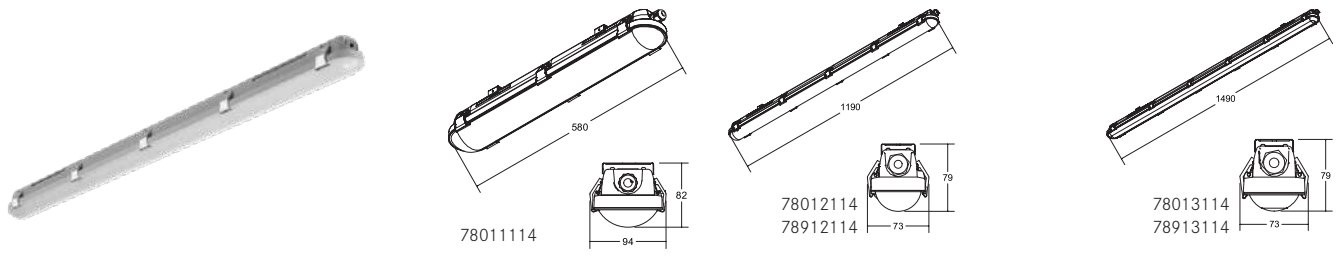

HUMID ONE LED moisture-proof bulkhead luminaire, switchable

Lamp: LED, colour rendering: CRI > 80, beam angle: 120°, material: polycarbonate / stainless steel, includes converter for connection to 230 V mains supply, switchable

Multilumen function: light can be switched down from 350 mA to 200 mA using the integrated dip switch.

Service life: L80/B50, 50,000 hrs (ta: +25 °C)

Delivery incl. mounting accessory set consisting of:

- 4 x locking screws for clip holder,
- 2 x locking screws and nuts for universal mounting bracket,
- 4 x (78012/78013 = 2 x) mounting screws and dowels,
- 2 x universal mounting brackets for wall, ceiling or pendant mounting (brackets required for hanging in the mounting bracket included in the delivery).
- 1 x IP65 cable gland PG13.5 (cable diameter Ø 6 – 12 mm)



| Article no. | Lumin. flux | Power | Colour temp. | Control | Length | Width | Price in € |
|-------------|-------------|-------|--------------|------------|----------|-------|------------|
| 78011114 | 2,300 lm | 18 W | 4,000 K | switchable | 580 mm | 94 mm | 39.90 |
| 78012114 | 2,300 lm | 18 W | 4,000 K | switchable | 1,190 mm | 73 mm | 49.90 |
| 78013114 | 3,600 lm | 28 W | 4,000 K | switchable | 1,490 mm | 73 mm | 59.90 |
| 78014114 | 4,500 lm | 35 W | 4,000 K | switchable | 1,190 mm | 94 mm | 59.90 |
| 78015114 | 6,900 lm | 51 W | 4,000 K | switchable | 1,490 mm | 94 mm | 69.90 |

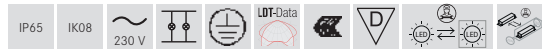

These items are subject to discount group 2.

Multilumen settings:

| Article number | Power at 200 mA | | Power at 250 mA | | Power at 300 mA | | Power at 350 mA | |
|----------------|-----------------|----------|-----------------|----------|-----------------|----------|-----------------|----------|
| 78011114 | 10 W | 1,250 lm | 13 W | 1,625 lm | 15 W | 1,875 lm | 18 W | 2,300 lm |
| 78012114 | 10 W | 1,250 lm | 13 W | 1,625 lm | 15 W | 1,875 lm | 18 W | 2,300 lm |
| 78013114 | 17 W | 2,125 lm | 20 W | 2,500 lm | 24 W | 3,000 lm | 28 W | 3,600 lm |
| 78014114 | 21 W | 2,625 lm | 25 W | 3,125 lm | 30 W | 3,750 lm | 35 W | 4,500 lm |
| 78015114 | 29 W | 3,625 lm | 36 W | 4,500 lm | 44 W | 5,500 lm | 51 W | 6,900 lm |

LED LIGHTING
FUNDING

BEG

IP65

IP65: the luminaire has complete protection against accidental contact. Dust cannot penetrate and it is protected against water jets in any direction.

HUMID ONE RESCUE LED moisture-proof bulkhead luminaire with 3 h emergency light battery

NEW



| Article no. | Luminous flux | Power | Colour temp. | Control | Length | Width | Price in € |
|-------------|---------------|-------|--------------|------------|----------|-------|------------|
| 78912114 | 2,300 lm | 18 W | 4,000 K | switchable | 1,190 mm | 73 mm | 279.90 |
| 78913114 | 3,600 lm | 28 W | 4,000 K | switchable | 1,490 mm | 73 mm | 299.90 |



These items are subject to discount group 2.

Accessories HUMID ONE moisture-proof bulkhead luminaire

| Article no. | Description | Price in € |
|-------------|---|------------|
| 81011060 | Through-wiring for 78011..., 580 mm, The set includes cable 3 x 1.5 mm ² (rigid), terminal block one-sided incl. screws | 4.20 |
| 81011120 | Through-wiring for 78012... / 78014..., 1,190 mm, The set includes cable 3 x 1.5 mm ² (rigid), terminal block one-sided incl. screws | 5.90 |
| 81011150 | Through-wiring for 78013... / 78015..., 1,490 mm, The set includes cable 3 x 1.5 mm ² (rigid), terminal block one-sided incl. screws | 7.60 |
| 81078030 | HUMID ONE conversion kit 3 h emergency light for 78012 / 78013 | 229.90 |



These items are subject to discount group 2.

Sizes in mm | All prices are recommended retail prices (RRP) in euros without VAT.
Errors excepted. | Orders are placed in accordance with our General Terms and Conditions of Sale printed on page 486 onwards.

MATRIX LED floodlight.

Flexible exterior applications.

Now in
2 new
sizes

More than 140 lm/W.



Product advantages:

- 5-year Brumberg guarantee
(Registration on the Brumberg website in the Services section).
- More than 140 lm/W.
- Dust-tight and waterproof with IP66.
- Internal cooling pins for optimum heat dissipation and long product life.
- Extremely temperature-resistant between -25 °C and +50 °C.
- Wall and mast mounting possible (using accessories).
- Powerful with 20 W, 50 W, 100 W, 225 W or 275 W.
- Corrosion-resistant housing made of die-cast aluminium with a pressure compensation valve built into the housing.

IP66 IK08

IP66 is the highest protection class against foreign objects combined with protection against powerful jets of water.

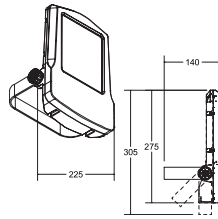

Micro
Art. no. 60801... / 60802...

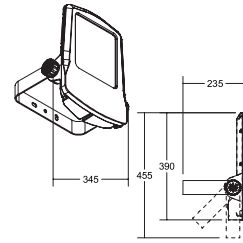

Mini
Art. no. 60803... / 60804...

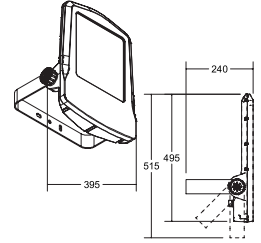

Midi
Art. no. 60805... / 60806...

MATRIX LED floodlight, IP66, switchable

NEW

Lamp: LED, colour rendering: CRI > 80, beam angle: 100°, material: aluminium / glass, includes converter for connection to 230 V mains voltage, switchable, cable length: 800 mm, incl. cable connector and with a pressure compensation valve built into the top of the housing.

Service life:

L80/B10, 50,000 hrs. (ta: +25 °C)

Symmetrical light distribution

| Article no. | Colour | Lumin. flux | Power | Colour temp. | System efficiency | Weight | Price in € |
|-------------|-------------------|-------------|-------|--------------|-------------------|---------|------------|
| 60801643 | matt titanium | 2,810 lm | 20 W | 3,000 K | 140 lm/W | 2.6 kg | 329.90 |
| 60801644 | matt titanium | 2,890 lm | 20 W | 4,000 K | 144 lm/W | 2.6 kg | 329.90 |
| 60803643 | matt titanium | 7,020 lm | 50 W | 3,000 K | 140 lm/W | 7.0 kg | 549.90 |
| 60803644 | matt titanium | 7,240 lm | 50 W | 4,000 K | 145 lm/W | 7.0 kg | 549.90 |
| 60805643 | matt titanium | 14,050 lm | 100 W | 3,000 K | 140 lm/W | 9.1 kg | 692.90 |
| 60805644 | matt titanium | 14,480 lm | 100 W | 4,000 K | 145 lm/W | 9.1 kg | 692.90 |
| 60807643 | NEW matt titanium | 28,900 lm | 225 W | 3,000 K | 128 lm/W | 19.0 kg | 1399.90 |
| 60807644 | NEW matt titanium | 30,900 lm | 225 W | 4,000 K | 137 lm/W | 19.0 kg | 1399.90 |
| 60809643 | NEW matt titanium | 34,100 lm | 275 W | 3,000 K | 124 lm/W | 19.0 kg | 1449.90 |
| 60809644 | NEW matt titanium | 36,500 lm | 275 W | 4,000 K | 132 lm/W | 19.0 kg | 1449.90 |

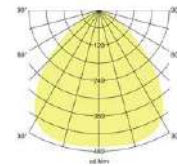

Asymmetrical light distribution

| Article no. | Colour | Lumin. flux | Power | Colour temp. | System efficiency | Weight | Price in € |
|-------------|-------------------|-------------|-------|--------------|-------------------|---------|------------|
| 60802643 | matt titanium | 2,500 lm | 20 W | 3,000 K | 125 lm/W | 2.6 kg | 329.90 |
| 60802644 | matt titanium | 2,710 lm | 20 W | 4,000 K | 136 lm/W | 2.6 kg | 329.90 |
| 60804643 | matt titanium | 8,036 lm | 50 W | 3,000 K | 160 lm/W | 7.0 kg | 549.90 |
| 60804644 | matt titanium | 8,466 lm | 50 W | 4,000 K | 169 lm/W | 7.0 kg | 549.90 |
| 60806643 | matt titanium | 13,380 lm | 100 W | 3,000 K | 133 lm/W | 9.1 kg | 692.90 |
| 60806644 | matt titanium | 14,100 lm | 100 W | 4,000 K | 141 lm/W | 9.1 kg | 692.90 |
| 60808643 | NEW matt titanium | 29,300 lm | 225 W | 3,000 K | 130 lm/W | 19.0 kg | 1399.90 |
| 60808644 | NEW matt titanium | 30,300 lm | 225 W | 4,000 K | 135 lm/W | 19.0 kg | 1399.90 |
| 60810643 | NEW matt titanium | 34,600 lm | 275 W | 3,000 K | 126 lm/W | 19.0 kg | 1449.90 |
| 60810644 | NEW matt titanium | 37,000 lm | 275 W | 4,000 K | 135 lm/W | 19.0 kg | 1449.90 |

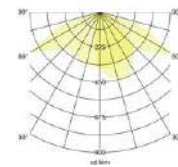

Beam angle: 30 x 110°

These items are subject to discount group 2.

Accessories for MATRIX LED floodlight

| Article no. | Description | Price in € |
|-------------|--|------------|
| 81100640 | Extension adapter for 20 W LED floodlights (Micro) | 120.90 |
| 81101640 | Extension adapter for 50 W LED floodlights (Mini) | 120.90 |
| 81102640 | Extension adapter for 100 W LED floodlights (Midi) | 120.90 |
| 81120640 | NEW Mast bracket for 20 W LED floodlights (Micro) | 36.90 |
| 81121640 | NEW Mast bracket for 50 W LED floodlights (Mini) | 36.90 |
| 81122640 | NEW Mast bracket for 100 W LED floodlights (Midi) | 36.90 |

These items are subject to discount group 2.



SOL Highbay.

LED highbay luminaire, Multi-lumen

Safe, effective lighting
for industrial plants.

LED LIGHTING
FUNDING

BEG

NEW: NOW
Multi-lumen



Product advantages:

- 5-year Brumberg guarantee.
(Registration on the Brumberg website in the Services section).
- BEG LED lighting funding.
- D-mark for fire-hazardous premises.
- Long service life: L80B50 > 50,000 hours at +25 °C.
- High luminous efficacy: 160 lm per watt.
- Dimmable by default: DALI-2.
- Extensive range of accessories.
- Degree of protection: IP65.
- Low-maintenance lighting realisation.
- Ambient temperature range: -25 to +45 °C.

IP65

IP65: the luminaire has complete protection against accidental contact. Dust cannot penetrate and it is protected against water jets in any direction.

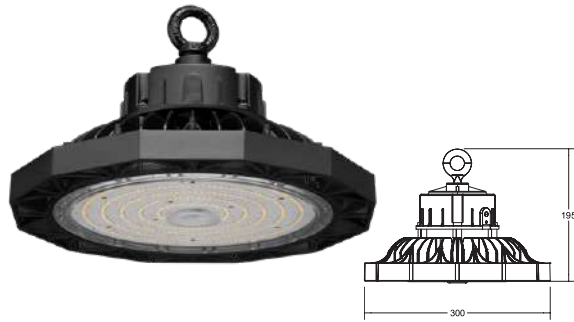

SOL LED highbay luminaire, DALI dimmable with Multi-lumen

Highbay LED highbay luminaire incl. power supply unit for 230 V mains voltage, DALI-2 dimmable

Lamp: LED, colour rendering: CRI > 80, power: max. 160 W, beam angle: 120°, material: aluminium / polycarbonate, includes screw-on fixing lug, shrink-on end caps on the DALI cable and connection cable 1,500 mm

| Article no. | Colour | Luminous flux | Colour temp. | Width | Height | System efficiency | Price in € |
|-------------|--------|---------------|--------------|--------|--------|-------------------|------------|
| 78313084 | black | 26,100 lm | 4,000 K | 300 mm | 195 mm | 163 lm/W | 369.90 |

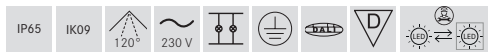

These items are subject to discount group 2.

Multilumen settings:

| Current feed | Power | Lumin. flux | 1 | 2 | 3 |
|--------------|-------|-------------|-----|-----|-----|
| 340mA | 85 W | 14,300 lm | Off | Off | Off |
| 420mA | 110 W | 17,900 lm | Off | Off | On |
| 500mA | 130 W | 21,200 lm | Off | On | Off |
| 620mA | 160 W | 26,100 lm | On | Off | Off |



SOL Highbay.

LED highbay luminaire, DALI-2 dimmable.

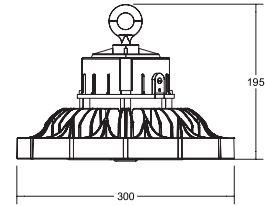
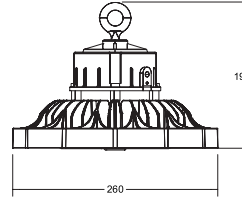
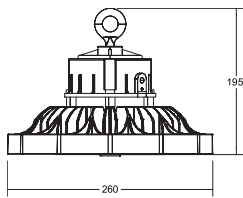

SOL LED highbay luminaire, DALI-2 dimmable

Highbay LED highbay luminaire incl. power supply unit for 230 V mains voltage, DALI-2 dimmable

Lamp: LED, colour rendering: CRI > 80, beam angle: 120°, material: aluminium / polycarbonate, includes screw-on fixing lug and connection cable 1,500 mm

Service life:

L80/B50, 50,000 hrs (ta: +25 °C)

120° (normal)

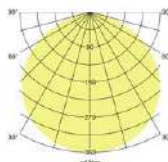

90° optics

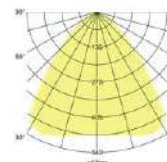

60° optics

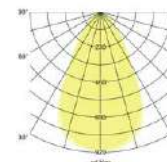

| Article no. | Colour | Luminous flux | Colour temp. | Power | Width | Height | System efficiency | Price in € |
|-------------|--------|---------------|--------------|-------|--------|--------|-------------------|------------|
| 78310084 | black | 12,100 lm | 4,000 K | 80 W | 260 mm | 195 mm | 151 lm/W | 274.90 |
| 78311084 | black | 18,000 lm | 4,000 K | 120 W | 260 mm | 195 mm | 150 lm/W | 307.90 |
| 78312084 | black | 24,800 lm | 4,000 K | 160 W | 300 mm | 195 mm | 155 lm/W | 351.90 |

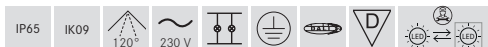

These items are subject to discount group 2.



Accessories SOL highbay luminaire

| Article no. | Description | Price in € |
|-------------|--|------------|
| 81060000 | Interchangeable optics SOL 60° for 78310 / 78311 | 13.10 |
| 81090000 | Interchangeable optics SOL 90° for 78310 / 78311 | 13.10 |
| 81062000 | Interchangeable optics SOL 60° for 78312 / 78313 | 13.10 |
| 81092000 | Interchangeable optics SOL 90° for 78312 / 78313 | 13.10 |
| <hr/> | | |
| 81045250 | SOL aluminium lamp shade for 78310 / 78311 | 32.90 |
| 81046250 | SOL aluminium lamp shade for 78312 / 78313 | 38.40 |
| 81048000 | SOL PC lamp shade for 78312 / 78313 | 79.10 |
| <hr/> | | |
| 81049080 | SOL ceiling/wall bracket | 32.90 |
| <hr/> | | |
| 81051000 | SOL chain suspension, 1,000 mm | 10.90 |
| 81052000 | SOL chain suspension, 2,000 mm | 21.80 |
| 81053000 | SOL chain suspension, 3,000 mm | 32.70 |
| 81055000 | SOL chain suspension, 5,000 mm | 54.50 |
| <hr/> | | |
| 81057000 | SOL cable connector, 3-pole, IP68, black | 13.10 |
| 81058000* | Y-cable connector SOL, 5-pole, IP68, black | 14.20 |
| 81050000 | SOL reducer, NPT 3/4" to M10 | 20.80 |

These items are subject to discount group 2.



Interchangeable optics



Aluminium lamp shade



PC lamp shade



Ceiling/wall bracket



Chain suspension



Cable connector



Reducer



Y-cable connector

* Function Y-connector:
1. Simplified through-wiring
2. DALI connection possible

Overview of glare reduction values

| UGR value | Article - combination | Luminous flux | Luminous flux / W |
|-----------|---|---------------|-------------------|
| < 19 | 78310084 (80 W) + 81060000 (60° interchangeable optics) + 81045250 (alu. lamp shade) | 11,400 lm | 142 lm/W |
| | 78311084 (120 W) + 81060000 (60° interchangeable optics) + 81045250 (alu. lamp shade) | 17,000 lm | 141 lm/W |
| | 78312084 (160 W) + 81062000 (60° interchangeable optics) + 81046250 (alu. lamp shade) | 23,600 lm | 147 lm/W |
| < 22 | 78310084 (80 W) + 81090000 (90° interchangeable optics) + 81045250 (alu. lamp shade) | 11,400 lm | 142 lm/W |
| | 78311084 (120 W) + 81045250 (aluminium lamp shade) | 15,400 lm | 128 lm/W |
| | 78312084 (160 W) + 81062000 (60° interchangeable optics) + 81048000 (PC lamp shade) | 21,600 lm | 135 lm/W |
| < 25 | 78310084 (80 W) + 81045250 (aluminium lamp shade) | 10,400 lm | 130 lm/W |
| | 78311084 (120 W) + 81090000 (90° interchangeable optics) + 81045250 (alu. lamp shade) | 17,100 lm | 142 lm/W |
| | 78312084 (160 W) + 81092000 (90° interchangeable optics) + 81046250 (alu. lamp shade) | 22,900 lm | 143 lm/W |
| | 78312084 (160 W) + 81046250 (aluminium lamp shade) | 22,500 lm | 140 lm/W |
| | 78312084 (160 W) + 81092000 (90° interchangeable optics) + 81048000 (PC lamp shade) | 23,500 lm | 146 lm/W |
| | 78312084 (160 W) + 81048000 (PC lamp shade) | 22,900 lm | 143 lm/W |
| < 28 | 78310084 (80 W) + 81060000 (60° interchangeable optics) | 12,100 lm | 151 lm/W |
| | 78310084 (80 W) + 81090000 (90° interchangeable optics) | 12,100 lm | 151 lm/W |
| | 78312084 (160 W) + 81062000 (60° interchangeable optics) | 24,400 lm | 152 lm/W |

RESCUE escape sign luminaires.

Find your way in an emergency.



To the product selection.



Product advantages:

- Made in Germany.
- 5-year Brumberg guarantee.
(Registration on the Brumberg website in the Services section).
- LiFePO₄ for long service lives and storage times
(Lithium iron phosphate) batteries. (*up to half a year, then reload)
- One light for all operating hours.
- 8 hours for accommodation facilities.
- 3 hours for all other areas.
- Self-adhesive pictogram set, quick replacement.
- Illumination of the escape sign > 200 cd/m².
- Technical design in accordance with EN 60598.2.22.
- All with AUTOTEST – function from outside with visible test LED,
which is carried out automatically by the light every 30 days.
- Rescue ONE: made of plastic, durable and robust
Rescue TWO: made of aluminium, aesthetic and functional

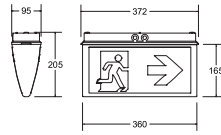

Incl. standard film set



RESCUE ONE escape sign luminaire, Ceiling or wall mounting

Detection distance: 32 m, rated operating time 3 h, nominal operating time can be switched to 8 h, then the emergency lighting factor (BLF) is still 40%, ceiling or wall mounting, incl. LiFe-PO4 single battery and pictogram set

Lamp: LED, lamp power: 2.4 W, system power: 4.6 W, material: polycarbonate, battery type: LiFe-PO4, monitoring device: automatic self-test

Other pictogram foils available on request.

| Article no. | Lumin. colour | Detection distance | Rated operating time with BLF 100% | Rated operating time with BLF 40% | Price in € |
|-------------|---------------|--------------------|------------------------------------|-----------------------------------|------------|
| 79030004 | 4,000 K | 32 m | 3 hours | 8 hours | 174.90 |



This item is subject to discount group 2.

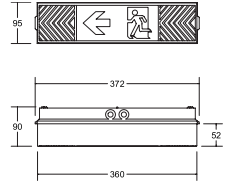

Incl. standard film set



RESCUE ONE escape sign luminaire, Wall mounting

Detection distance: 18 m, rated operating time 3 h, nominal operating time can be switched to 8 h, then the emergency lighting factor (BLF) is still 40%, wall mounting, incl. LiFe-PO4 single battery and pictogram set

Lamp: LED, lamp power: 2.4 W, system power: 4.6 W, material: polycarbonate, battery type: LiFe-PO4, monitoring device: automatic self-test

Other pictogram foils available on request.

| Article no. | Lumin. colour | Detection distance | Rated operating time with BLF 100% | Rated operating time with BLF 40% | Price in € |
|-------------|---------------|--------------------|------------------------------------|-----------------------------------|------------|
| 79130004 | 4,000 K | 18 m | 3 hours | 8 hours | 152.90 |



This item is subject to discount group 2.

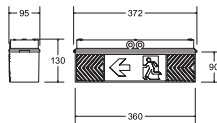

Incl. standard film set



RESCUE ONE escape sign luminaire, Ceiling or wall mounting

Detection distance: 18 m, rated operating time 3 h, nominal operating time can be switched to 8 h, then the emergency lighting factor (BLF) is still 40%, ceiling or wall mounting, incl. LiFe-PO4 single battery and pictogram set

Lamp: LED, lamp power: 2.4 W, system power: 4.6 W, material: polycarbonate, battery type: LiFe-PO4, monitoring device: automatic self-test

Other pictogram foils available on request.

| Article no. | Lumin. colour | Detection distance | Rated operating time with BLF 100% | Rated operating time with BLF 40% | Price in € |
|-------------|---------------|--------------------|------------------------------------|-----------------------------------|------------|
| 79031004 | 4,000 K | 18 m | 3 hours | 8 hours | 163.90 |



This item is subject to discount group 2.



Optional accessories:



Pendant cable set for 7903...

- 81172050 pendant cable set 500 mm, price: 63.80 €
- 81172100 pendant cable set 1,000 mm, price: 71.80 €



Ceiling installation set for 7903...

- 81173000 ceiling installation set
- Price: 95.70 €

These items are subject to discount group 2.

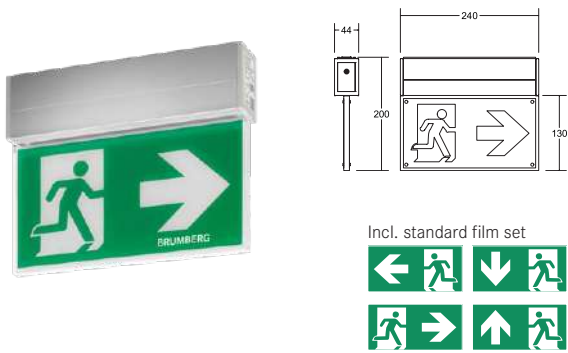

RESCUE TWO escape sign luminaire, Ceiling or wall mounting

Detection distance: 25 m, rated operating time 3 h, nominal operating time can be switched to 8 h, then the emergency lighting factor (BLF) is still 40%, ceiling or wall mounting, incl. LiFe-PO4 single battery and pictogram set

Lamp: LED, lamp power: 2.4 W, system power: 4.6 W, material: aluminium / polycarbonate, battery type: LiFePO4, monitoring device: automatic self-test

Other pictogram foils available on request.

| Article no. | Lumin. colour | Detection distance | Rated operating time with BLF 100% | Rated operating time with BLF 40% | Price in € |
|-------------|---------------|--------------------|------------------------------------|-----------------------------------|------------|
| 79230264 | 4,000 K | 25 m | 3 hours | 8 hours | 251.90 |



This item is subject to discount group 2.

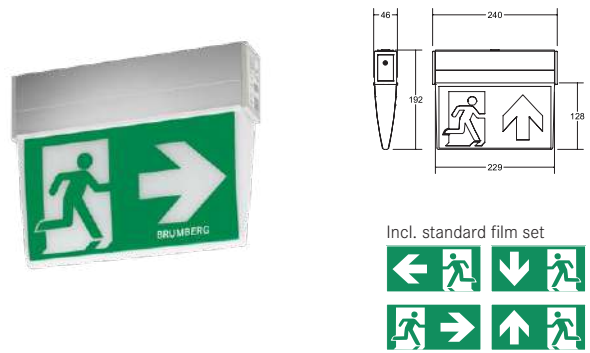

RESCUE TWO escape sign luminaire, Ceiling or wall mounting

Detection distance: 25 m, rated operating time 3 h, nominal operating time can be switched to 8 h, then the emergency lighting factor (BLF) is still 40%, ceiling or wall mounting, incl. LiFe-PO4 single battery and pictogram set

Lamp: LED, lamp power: 2.4 W, system power: 4.6 W, material: aluminium / polycarbonate, battery type: LiFePO4, monitoring device: automatic self-test

Other pictogram foils available on request.

| Article no. | Lumin. colour | Detection distance | Rated operating time with BLF 100% | Rated operating time with BLF 40% | Price in € |
|-------------|---------------|--------------------|------------------------------------|-----------------------------------|------------|
| 79231264 | 4,000 K | 25 m | 3 hours | 8 hours | 207.90 |



This item is subject to discount group 2.



Optional accessories:



Central pendant cable for 79230... and 79231...
 Length 300 mm, article no. 811 70030, price: 43.90 €
 Length 500 mm, article no. 811 70050, price: 47.90 €
 Length 1,000 mm, article no. 811 70100, price: 51.90 €



Ceiling installation set for 79230...
 Article no. 811 71001, price: 76.20 €

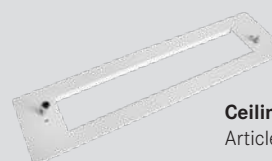

Ceiling installation set for 79231...
 Article no. 811 71000, price: 71.80 €

These items are subject to discount group 2.

LED escape sign luminaires.

Test functions.

Autotest

- Function test: 30 days after switching on the supply voltage, test duration: 5min
- Capacity test: the 12th function test is carried out as an endurance test, test duration: 3/8h

Manual test

- Press the "Test" button for approx. 2 seconds
- Automatically ends after 5 minutes
- Premature cancellation of a manual test: press the button for 3 seconds, until the status indicator LED lights up green or blinks

Lights with test delay

- Not all escape sign or emergency luminaires in a room can perform the function test at the same time
- Half of the lights are equipped with the required test delay at the factory (sticker "Test delay" on reflector)
- Press and hold the test button for at least 6 seconds until the status LED starts blinks alternately red/green
- LED lights up "green" = test delay is inactive
- LED lights up "red" = test delay is active
- Press the button again briefly: status change
- To save the setting, press and hold the test button for longer than 3 seconds during the selected status.
- Status LED blinks, release test button. Configuration is saved

Function display LED

- Green (permanent) Mains available, charge OK
- Off Mains missing, emergency operation
- Red blinking (2 sec cycle) Lamp failure
- Red blinking (1 sec cycle) Battery capacity error
- Red (permanent) Charging error, battery error
- Orange blinking (1 sec cycle) Function test in progress
- Orange blinking (2 sec cycle) Burning time test in progress



LAVILO.

LED wall washer.

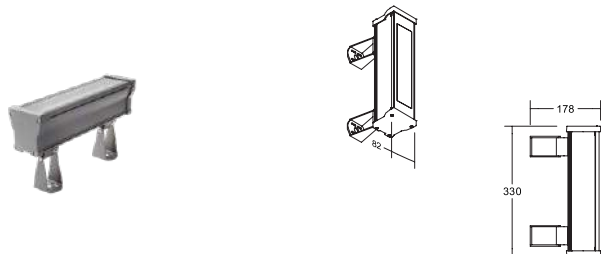

LAVILO I MICRO LED wall washer, IP66, DALI NEW

Lamp: LED, colour rendering: CRI > 80, power: 11 W, material: aluminium / glass, includes converter for connection to 230 V mains voltage, DALI-2 dimmable.

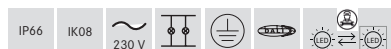

| Article no. | Colour | Lumin. flux | Colour temp. | Beam angle | Price in € |
|---|---------------|-------------|--------------|------------|------------|
| 60831647 NEW | matt titanium | 1,290 lm | 2,700 K | 10° x 40° | 349.90 |
| 60831643 NEW | matt titanium | 1,320 lm | 3,000 K | 10° x 40° | 349.90 |
| 60831645 NEW | matt titanium | 1,350 lm | 3,500 K | 10° x 40° | 349.90 |
| 60831644 NEW | matt titanium | 1,370 lm | 4,000 K | 10° x 40° | 349.90 |
| 60831646 NEW | matt titanium | 1,400 lm | 6,000 K | 10° x 40° | 349.90 |
| 60831642 NEW | matt titanium | 1,290 lm | RGBW | 10° x 40° | 399.90 |

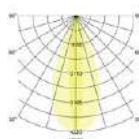

| | | | | | |
|---|---------------|----------|---------|-----|--------|
| 60832647 NEW | matt titanium | 1,360 lm | 2,700 K | 20° | 349.90 |
| 60832643 NEW | matt titanium | 1,390 lm | 3,000 K | 20° | 349.90 |
| 60832645 NEW | matt titanium | 1,410 lm | 3,500 K | 20° | 349.90 |
| 60832644 NEW | matt titanium | 1,440 lm | 4,000 K | 20° | 349.90 |
| 60832646 NEW | matt titanium | 1,470 lm | 6,000 K | 20° | 349.90 |
| 60832642 NEW | matt titanium | 1,360 lm | RGBW | 20° | 399.90 |

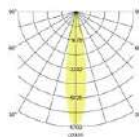

| | | | | | |
|---|---------------|----------|---------|-----|--------|
| 60833647 NEW | matt titanium | 1,340 lm | 2,700 K | 30° | 349.90 |
| 60833643 NEW | matt titanium | 1,370 lm | 3,000 K | 30° | 349.90 |
| 60833645 NEW | matt titanium | 1,400 lm | 3,500 K | 30° | 349.90 |
| 60833644 NEW | matt titanium | 1,430 lm | 4,000 K | 30° | 349.90 |
| 60833646 NEW | matt titanium | 1,450 lm | 6,000 K | 30° | 349.90 |
| 60833642 NEW | matt titanium | 1,340 lm | RGBW | 30° | 399.90 |

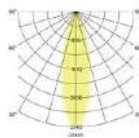

| | | | | | |
|---|---------------|----------|---------|-----|--------|
| 60835647 NEW | matt titanium | 1,320 lm | 2,700 K | 50° | 349.90 |
| 60835643 NEW | matt titanium | 1,350 lm | 3,000 K | 50° | 349.90 |
| 60835645 NEW | matt titanium | 1,380 lm | 3,500 K | 50° | 349.90 |
| 60835644 NEW | matt titanium | 1,410 lm | 4,000 K | 50° | 349.90 |
| 60835646 NEW | matt titanium | 1,430 lm | 6,000 K | 50° | 349.90 |
| 60835642 NEW | matt titanium | 1,320 lm | RGBW | 50° | 399.90 |

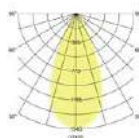

This item is subject to discount group 2.

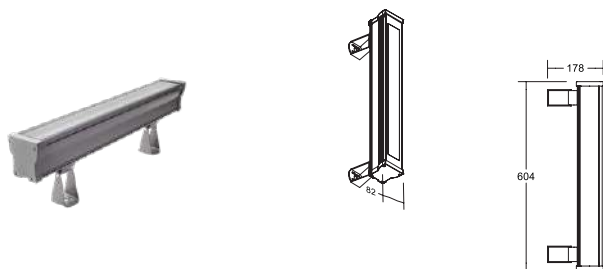

LAVILO I MINI LED wall washer, IP66, DALI

NEW

Lamp: LED, colour rendering: CRI > 80, power: 22 W, material: aluminium / glass, includes converter for connection to 230 V mains voltage, DALI-2.



| Article no. | Colour | Lumin. flux | Colour temp. | Beam angle | Price in € |
|-------------|--------------------------|-------------|--------------|------------|------------|
| 60841647 | NEW matt titanium | 2,590 lm | 2,700 K | 10° x 40° | 449.90 |
| 60841643 | NEW matt titanium | 2,640 lm | 3,000 K | 10° x 40° | 449.90 |
| 60841645 | NEW matt titanium | 2,700 lm | 3,500 K | 10° x 40° | 449.90 |
| 60841644 | NEW matt titanium | 2,750 lm | 4,000 K | 10° x 40° | 449.90 |
| 60841646 | NEW matt titanium | 2,800 lm | 6,000 K | 10° x 40° | 449.90 |
| 60841642 | NEW matt titanium | 2,590 lm | RGBW | 10° x 40° | 499.90 |

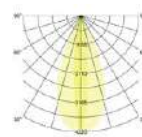

| | | | | | |
|----------|--------------------------|----------|---------|-----|--------|
| 60842647 | NEW matt titanium | 2,720 lm | 2,700 K | 20° | 449.90 |
| 60842643 | NEW matt titanium | 2,780 lm | 3,000 K | 20° | 449.90 |
| 60842645 | NEW matt titanium | 2,830 lm | 3,500 K | 20° | 449.90 |
| 60842644 | NEW matt titanium | 2,890 lm | 4,000 K | 20° | 449.90 |
| 60842646 | NEW matt titanium | 2,940 lm | 6,000 K | 20° | 449.90 |
| 60842642 | NEW matt titanium | 2,720 lm | RGBW | 20° | 499.90 |

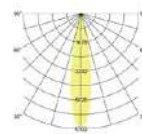

| | | | | | |
|----------|--------------------------|----------|---------|-----|--------|
| 60843647 | NEW matt titanium | 2,690 lm | 2,700 K | 30° | 449.90 |
| 60843643 | NEW matt titanium | 2,750 lm | 3,000 K | 30° | 449.90 |
| 60843645 | NEW matt titanium | 2,800 lm | 3,500 K | 30° | 449.90 |
| 60843644 | NEW matt titanium | 2,860 lm | 4,000 K | 30° | 449.90 |
| 60843646 | NEW matt titanium | 2,940 lm | 6,000 K | 30° | 449.90 |
| 60843642 | NEW matt titanium | 2,690 lm | RGBW | 30° | 499.90 |

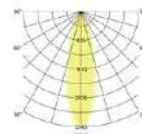

| | | | | | |
|----------|--------------------------|----------|---------|-----|--------|
| 60845647 | NEW matt titanium | 2,650 lm | 2,700 K | 50° | 449.90 |
| 60845643 | NEW matt titanium | 2,700 lm | 3,000 K | 50° | 449.90 |
| 60845645 | NEW matt titanium | 2,760 lm | 3,500 K | 50° | 449.90 |
| 60845644 | NEW matt titanium | 2,820 lm | 4,000 K | 50° | 449.90 |
| 60845646 | NEW matt titanium | 2,870 lm | 6,000 K | 50° | 449.90 |
| 60845642 | NEW matt titanium | 2,650 lm | RGBW | 50° | 499.90 |

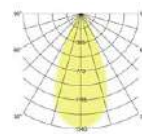

This item is subject to discount group 2.

LAVILO.

LED wall washer.

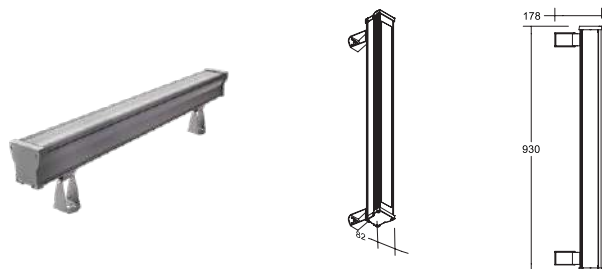

LAVILO I MIDI LED wall washer, IP66, DALI NEW

Lamp: LED, colour rendering: CRI > 80, power: 33 W, material: aluminium / glass, includes converter for connection to 230 V mains voltage, DALI-2 dimmable.

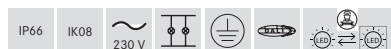

| Article no. | Colour | Lumin. flux | Colour temp. | Beam angle | Price in € |
|-------------|--|-------------|--------------|------------|------------|
| 60851647 | NEW matt titanium | 3,890 lm | 2,700 K | 10° x 40° | 549.90 |
| 60851643 | NEW matt titanium | 3,970 lm | 3,000 K | 10° x 40° | 549.90 |
| 60851645 | NEW matt titanium | 4,050 lm | 3,500 K | 10° x 40° | 549.90 |
| 60851644 | NEW matt titanium | 4,130 lm | 4,000 K | 10° x 40° | 549.90 |
| 60851646 | NEW matt titanium | 4,210 lm | 6,000 K | 10° x 40° | 549.90 |
| 60851642 | NEW matt titanium | 3,890 lm | RGBW | 10° x 40° | 599.90 |

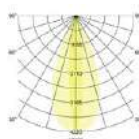

| | | | | | |
|----------|--|----------|---------|-----|--------|
| 60852647 | NEW matt titanium | 4,080 lm | 2,700 K | 20° | 549.90 |
| 60852643 | NEW matt titanium | 4,170 lm | 3,000 K | 20° | 549.90 |
| 60852645 | NEW matt titanium | 4,250 lm | 3,500 K | 20° | 549.90 |
| 60852644 | NEW matt titanium | 4,340 lm | 4,000 K | 20° | 549.90 |
| 60852646 | NEW matt titanium | 4,420 lm | 6,000 K | 20° | 549.90 |
| 60852642 | NEW matt titanium | 4,080 lm | RGBW | 20° | 599.90 |

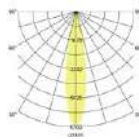

| | | | | | |
|----------|--|----------|---------|-----|--------|
| 60853647 | NEW matt titanium | 4,040 lm | 2,700 K | 30° | 549.90 |
| 60853643 | NEW matt titanium | 4,120 lm | 3,000 K | 30° | 549.90 |
| 60853645 | NEW matt titanium | 4,210 lm | 3,500 K | 30° | 549.90 |
| 60853644 | NEW matt titanium | 4,290 lm | 4,000 K | 30° | 549.90 |
| 60853646 | NEW matt titanium | 4,370 lm | 6,000 K | 30° | 549.90 |
| 60853642 | NEW matt titanium | 4,040 lm | RGBW | 30° | 599.90 |

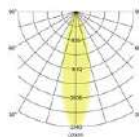

| | | | | | |
|----------|--|----------|---------|-----|--------|
| 60855647 | NEW matt titanium | 3,980 lm | 2,700 K | 50° | 549.90 |
| 60855643 | NEW matt titanium | 4,060 lm | 3,000 K | 50° | 549.90 |
| 60855645 | NEW matt titanium | 4,140 lm | 3,500 K | 50° | 549.90 |
| 60855644 | NEW matt titanium | 4,230 lm | 4,000 K | 50° | 549.90 |
| 60855646 | NEW matt titanium | 4,300 lm | 6,000 K | 50° | 549.90 |
| 60855642 | NEW matt titanium | 3,980 lm | RGBW | 50° | 599.90 |

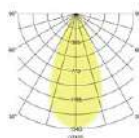

This item is subject to discount group 2.

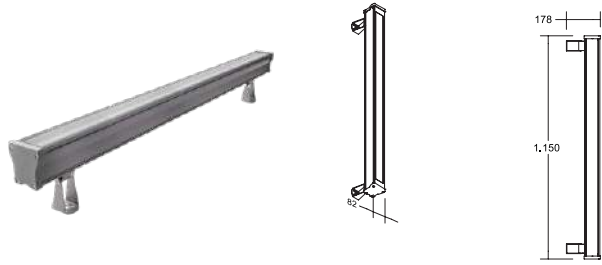

LAVILO I MAXI LED wall washer, IP66, DALI NEW

Lamp: LED, colour rendering: CRI > 80, power: 44 W,
material: aluminium / glass, includes converter for
connection to 230 V mains voltage, DALI-2 dimmable.



| Article no. | Colour | Lumin. flux | Colour temp. | Beam angle | Price in € |
|-------------|--|-------------|--------------|------------|------------|
| 60861647 | NEW matt titanium | 5,180 lm | 2,700 K | 10° x 40° | 649.90 |
| 60861643 | NEW matt titanium | 5,290 lm | 3,000 K | 10° x 40° | 649.90 |
| 60861645 | NEW matt titanium | 5,400 lm | 3,500 K | 10° x 40° | 649.90 |
| 60861644 | NEW matt titanium | 5,510 lm | 4,000 K | 10° x 40° | 649.90 |
| 60861646 | NEW matt titanium | 5,610 lm | 6,000 K | 10° x 40° | 649.90 |
| 60861642 | NEW matt titanium | 5,290 lm | RGBW | 10° x 40° | 699.90 |

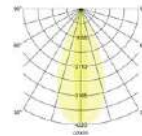

| | | | | | |
|----------|--|----------|---------|-----|--------|
| 60862647 | NEW matt titanium | 5,440 lm | 2,700 K | 20° | 649.90 |
| 60862643 | NEW matt titanium | 5,560 lm | 3,000 K | 20° | 649.90 |
| 60862645 | NEW matt titanium | 5,670 lm | 3,500 K | 20° | 649.90 |
| 60862644 | NEW matt titanium | 5,780 lm | 4,000 K | 20° | 649.90 |
| 60862646 | NEW matt titanium | 5,890 lm | 6,000 K | 20° | 649.90 |
| 60862642 | NEW matt titanium | 5,440 lm | RGBW | 20° | 699.90 |

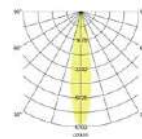

| | | | | | |
|----------|--|----------|---------|-----|--------|
| 60863647 | NEW matt titanium | 5,390 lm | 2,700 K | 30° | 649.90 |
| 60863643 | NEW matt titanium | 5,500 lm | 3,000 K | 30° | 649.90 |
| 60863645 | NEW matt titanium | 5,610 lm | 3,500 K | 30° | 649.90 |
| 60863644 | NEW matt titanium | 5,730 lm | 4,000 K | 30° | 649.90 |
| 60863646 | NEW matt titanium | 5,830 lm | 6,000 K | 30° | 649.90 |
| 60863642 | NEW matt titanium | 5,390 lm | RGBW | 30° | 699.90 |

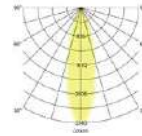

| | | | | | |
|----------|--|----------|---------|-----|--------|
| 60865647 | NEW matt titanium | 5,300 lm | 2,700 K | 50° | 649.90 |
| 60865643 | NEW matt titanium | 5,410 lm | 3,000 K | 50° | 649.90 |
| 60865645 | NEW matt titanium | 5,520 lm | 3,500 K | 50° | 649.90 |
| 60865644 | NEW matt titanium | 5,640 lm | 4,000 K | 50° | 649.90 |
| 60865646 | NEW matt titanium | 5,740 lm | 6,000 K | 50° | 649.90 |
| 60865642 | NEW matt titanium | 5,300 lm | RGBW | 50° | 699.90 |

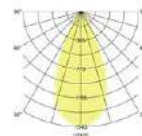

This item is subject to discount group 2.



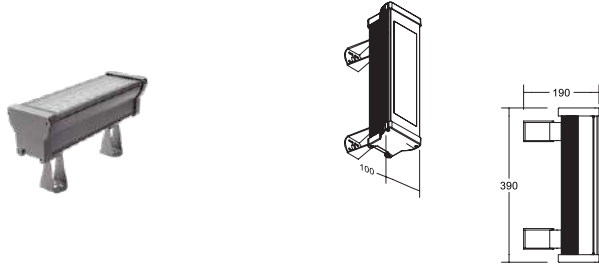

LAVILO II MICRO LED wall washer, IP66, DALI

NEW

Lamp: LED, colour rendering: CRI > 80, power: 21 W, material: aluminium / glass, includes converter for connection to 230 V mains voltage, DALI-2 dimmable.



| Article no. | Colour | Lumin. flux | Colour temp. | Beam angle | Price in € |
|-------------|-------------------|-------------|--------------|------------|------------|
| 60871647 | NEW matt titanium | 2,500 lm | 2,700 K | 10° x 40° | 449.90 |
| 60871643 | NEW matt titanium | 2,550 lm | 3,000 K | 10° x 40° | 449.90 |
| 60871645 | NEW matt titanium | 2,600 lm | 3,500 K | 10° x 40° | 449.90 |
| 60871644 | NEW matt titanium | 2,650 lm | 4,000 K | 10° x 40° | 449.90 |
| 60871646 | NEW matt titanium | 2,710 lm | 6,000 K | 10° x 40° | 449.90 |
| 60871642 | NEW matt titanium | 2,500 lm | RGBW | 10° x 40° | 499.90 |
| | | | | | |
| 60872647 | NEW matt titanium | 2,620 lm | 2,700 K | 20° | 449.90 |
| 60872643 | NEW matt titanium | 2,680 lm | 3,000 K | 20° | 449.90 |
| 60872645 | NEW matt titanium | 2,730 lm | 3,500 K | 20° | 449.00 |
| 60872644 | NEW matt titanium | 2,790 lm | 4,000 K | 20° | 449.90 |
| 60872646 | NEW matt titanium | 2,840 lm | 6,000 K | 20° | 449.00 |
| 60872642 | NEW matt titanium | 2,620 lm | RGBW | 20° | 499.90 |
| | | | | | |
| 60873647 | NEW matt titanium | 2,590 lm | 2,700 K | 30° | 449.90 |
| 60873643 | NEW matt titanium | 2,650 lm | 3,000 K | 30° | 449.90 |
| 60873645 | NEW matt titanium | 2,700 lm | 3,500 K | 30° | 449.90 |
| 60873644 | NEW matt titanium | 2,760 lm | 4,000 K | 30° | 449.90 |
| 60873646 | NEW matt titanium | 2,820 lm | 6,000 K | 30° | 449.90 |
| 60873642 | NEW matt titanium | 2,590 lm | RGBW | 30° | 499.90 |
| | | | | | |
| 60875647 | NEW matt titanium | 2,550 lm | 2,700 K | 50° | 449.90 |
| 60875643 | NEW matt titanium | 2,610 lm | 3,000 K | 50° | 449.90 |
| 60875645 | NEW matt titanium | 2,660 lm | 3,500 K | 50° | 449.90 |
| 60875644 | NEW matt titanium | 2,710 lm | 4,000 K | 50° | 449.90 |
| 60875646 | NEW matt titanium | 2,770 lm | 6,000 K | 50° | 449.90 |
| 60875642 | NEW matt titanium | 2,550 lm | RGBW | 50° | 499.90 |

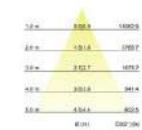
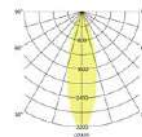
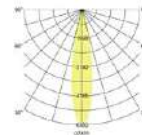
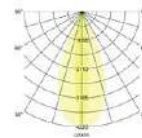

This item is subject to discount group 2.

LAVILO.

LED wall washer.

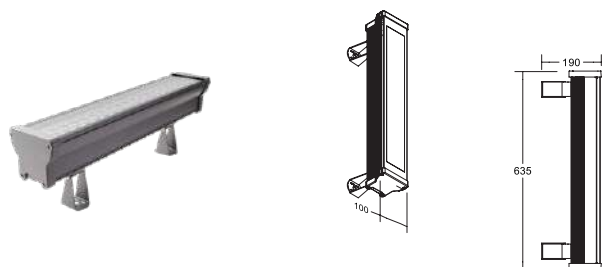

LAVILO II MINI LED wall washer, IP66, DALI NEW

Lamp: LED, colour rendering: CRI > 80, power: 42 W, material: aluminium / glass, includes converter for connection to 230 V mains voltage, DALI-2 dimmable.



| Article no. | Colour | Lumin. flux | Colour temp. | Beam angle | Price in € |
|---|---------------|-------------|--------------|------------|------------|
| 60881647 NEW | matt titanium | 5,000 lm | 2,700 K | 10° x 40° | 549.90 |
| 60881643 NEW | matt titanium | 5,100 lm | 3,000 K | 10° x 40° | 549.90 |
| 60881645 NEW | matt titanium | 5,200 lm | 3,500 K | 10° x 40° | 549.90 |
| 60881644 NEW | matt titanium | 5,310 lm | 4,000 K | 10° x 40° | 549.90 |
| 60881646 NEW | matt titanium | 5,420 lm | 6,000 K | 10° x 40° | 549.90 |
| 60881642 NEW | matt titanium | 5,000 lm | RGBW | 10° x 40° | 699.90 |

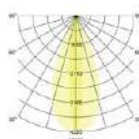

| | | | | | |
|---|---------------|----------|---------|-----|--------|
| 60882647 NEW | matt titanium | 5,250 lm | 2,700 K | 20° | 549.90 |
| 60882643 NEW | matt titanium | 5,360 lm | 3,000 K | 20° | 549.90 |
| 60882645 NEW | matt titanium | 5,460 lm | 3,500 K | 20° | 549.90 |
| 60882644 NEW | matt titanium | 5,580 lm | 4,000 K | 20° | 549.90 |
| 60882646 NEW | matt titanium | 5,690 lm | 6,000 K | 20° | 549.90 |
| 60882642 NEW | matt titanium | 5,250 lm | RGBW | 20° | 699.90 |

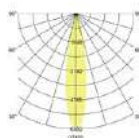

| | | | | | |
|---|---------------|----------|---------|-----|--------|
| 60883647 NEW | matt titanium | 5,190 lm | 2,700 K | 30° | 549.90 |
| 60883643 NEW | matt titanium | 5,300 lm | 3,000 K | 30° | 549.90 |
| 60883645 NEW | matt titanium | 5,410 lm | 3,500 K | 30° | 549.90 |
| 60883644 NEW | matt titanium | 5,520 lm | 4,000 K | 30° | 549.90 |
| 60883646 NEW | matt titanium | 5,640 lm | 6,000 K | 30° | 549.90 |
| 60883642 NEW | matt titanium | 5,190 lm | RGBW | 30° | 699.90 |

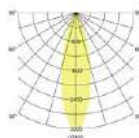

| | | | | | |
|---|---------------|----------|---------|-----|--------|
| 60885647 NEW | matt titanium | 5,110 lm | 2,700 K | 50° | 549.90 |
| 60885643 NEW | matt titanium | 5,220 lm | 3,000 K | 50° | 549.90 |
| 60885645 NEW | matt titanium | 5,320 lm | 3,500 K | 50° | 549.90 |
| 60885644 NEW | matt titanium | 5,430 lm | 4,000 K | 50° | 549.90 |
| 60885646 NEW | matt titanium | 5,550 lm | 6,000 K | 50° | 549.90 |
| 60885642 NEW | matt titanium | 5,110 lm | RGBW | 50° | 699.90 |

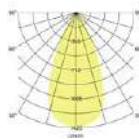

This item is subject to discount group 2.

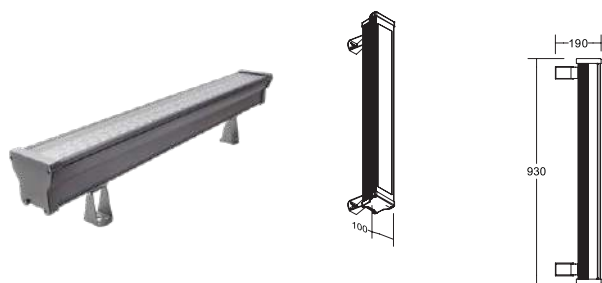

LAVILO II MIDI LED wall washer, IP66, DALI NEW

Lamp: LED, colour rendering: CRI > 80, power: 63 W, material: aluminium / glass, includes converter for connection to 230 V mains voltage, DALI-2 dimmable.



| Article no. | Colour | Lumin. flux | Colour temp. | Beam angle | Price in € |
|-------------|--|-------------|--------------|------------|------------|
| 60891647 | NEW matt titanium | 7,500 lm | 2,700 K | 10° x 40° | 899.90 |
| 60891643 | NEW matt titanium | 7,650 lm | 3,000 K | 10° x 40° | 899.90 |
| 60891645 | NEW matt titanium | 7,812 lm | 3,500 K | 10° x 40° | 899.90 |
| 60891644 | NEW matt titanium | 7,970 lm | 4,000 K | 10° x 40° | 899.90 |
| 60891646 | NEW matt titanium | 8,130 lm | 6,000 K | 10° x 40° | 899.90 |
| 60891642 | NEW matt titanium | 7,500 lm | RGBW | 10° x 40° | 999.90 |

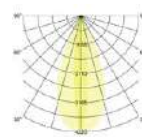

| | | | | | |
|----------|--|----------|---------|-----|--------|
| 60892647 | NEW matt titanium | 7,870 lm | 2,700 K | 20° | 899.90 |
| 60892643 | NEW matt titanium | 8,040 lm | 3,000 K | 20° | 899.90 |
| 60892645 | NEW matt titanium | 8,200 lm | 3,500 K | 20° | 899.90 |
| 60892644 | NEW matt titanium | 8,370 lm | 4,000 K | 20° | 899.90 |
| 60892646 | NEW matt titanium | 8,540 lm | 6,000 K | 20° | 899.90 |
| 60892642 | NEW matt titanium | 7,870 lm | RGBW | 20° | 999.90 |

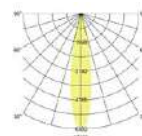

| | | | | | |
|----------|--|----------|---------|-----|--------|
| 60893647 | NEW matt titanium | 7,790 lm | 2,700 K | 30° | 899.90 |
| 60893643 | NEW matt titanium | 7,960 lm | 3,000 K | 30° | 899.90 |
| 60893645 | NEW matt titanium | 8,120 lm | 3,500 K | 30° | 899.90 |
| 60893644 | NEW matt titanium | 8,280 lm | 4,000 K | 30° | 899.90 |
| 60893646 | NEW matt titanium | 8,460 lm | 6,000 K | 30° | 899.90 |
| 60893642 | NEW matt titanium | 7,790 lm | RGBW | 30° | 999.90 |

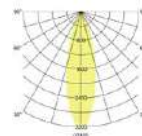

| | | | | | |
|----------|--|----------|---------|-----|--------|
| 60895647 | NEW matt titanium | 7,670 lm | 2,700 K | 50° | 899.90 |
| 60895643 | NEW matt titanium | 7,830 lm | 3,000 K | 50° | 899.90 |
| 60895645 | NEW matt titanium | 7,990 lm | 3,500 K | 50° | 899.90 |
| 60895644 | NEW matt titanium | 8,150 lm | 4,000 K | 50° | 899.90 |
| 60895646 | NEW matt titanium | 8,320 lm | 6,000 K | 50° | 899.90 |
| 60895642 | NEW matt titanium | 7,670 lm | RGBW | 50° | 999.90 |

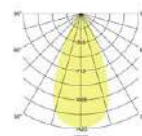

This item is subject to discount group 2.

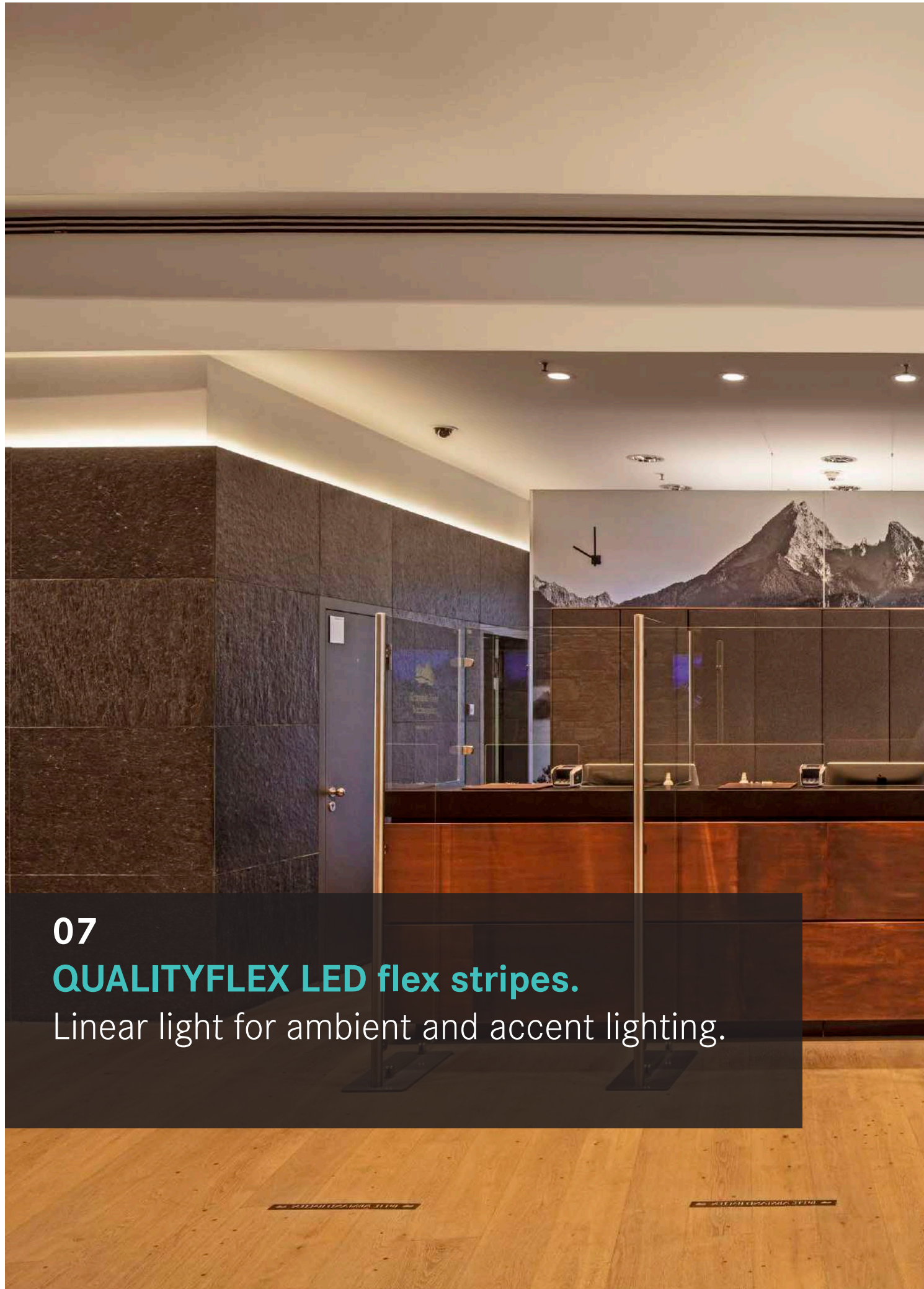

07

QUALITYFLEX LED flex stripes.

Linear light for ambient and accent lighting.

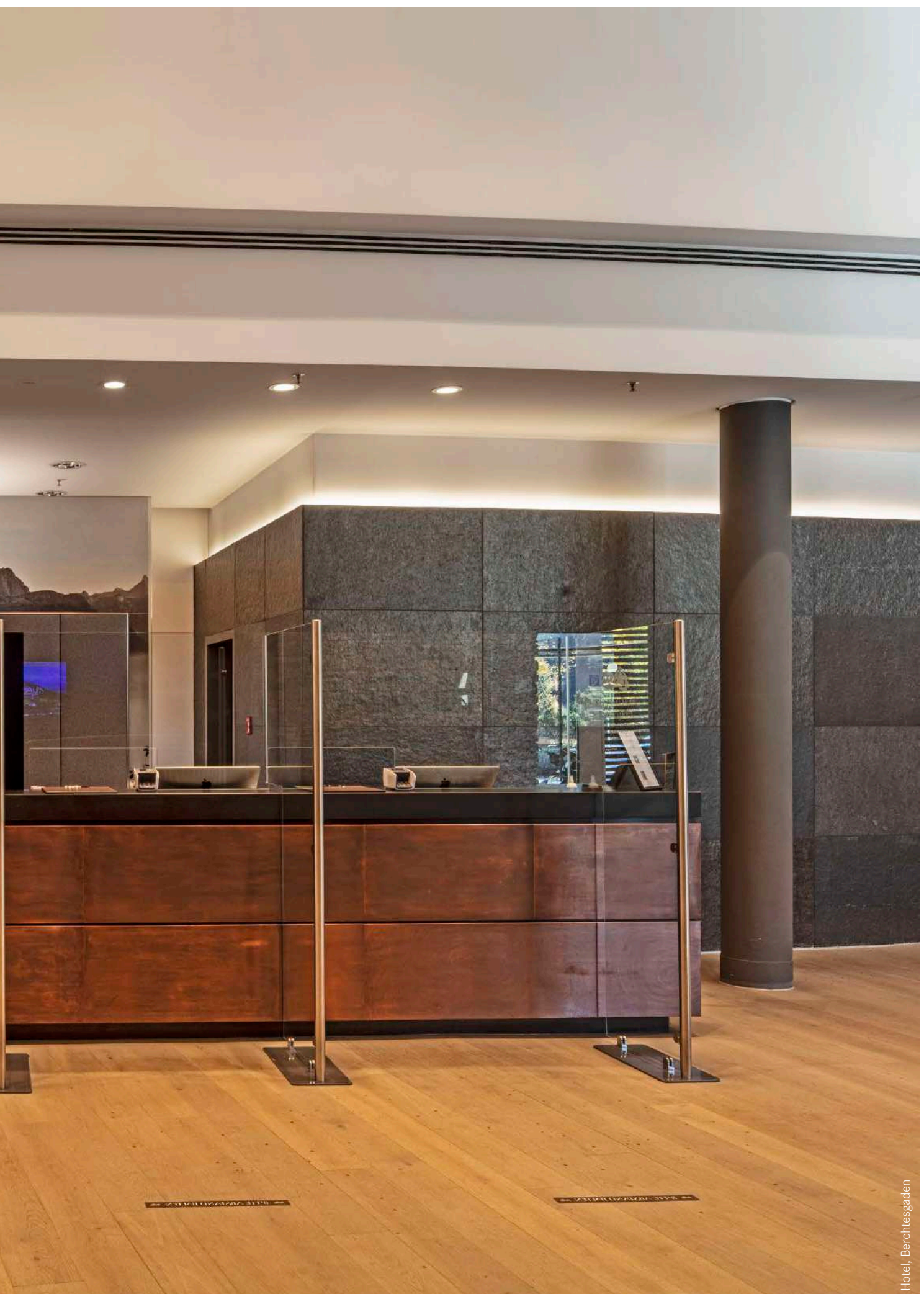

QUALITYFLEX Select HE

LED flex stripe, 5 m, CRI > 90, 4.8 W / m

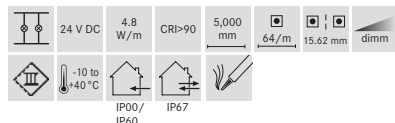
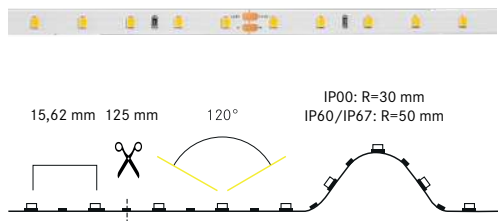

NEW

Electrical data

| | |
|-----------------------|---------------|
| LED circuit board: | SMD-LED 2835 |
| Power consumption: | 4.8 W/m |
| LED number per metre: | 64 |
| Rated voltage: | 24 V DC |
| Protection class: | III |
| Ambient temperature: | -10 to +40 °C |

Photometric data

| | |
|-------------------------|---------------------------|
| Colour rendering index: | CRI > 90 |
| Efficiency: | 146 lm/W at IP00, 3,000 K |

Photometric data

| | |
|-------------|------|
| Beam angle: | 120° |
|-------------|------|

Service life:

| | |
|---------------|--|
| Service life: | L80/B10: 123,000 h L70/B50: 181,000 h |
|---------------|--|

Mechanical data

| | |
|------------------------------|-------------------------------------|
| Length of the circuit board: | 5,000 mm |
| max. module length: | 5,000 mm |
| Pitch: | 125 mm |
| Smallest bending radius: | IP00: R=30 mm IP60/IP67: R=50 mm |
| Short pitch: | 15.62 mm |
| Connection cable: | 2 x 350 mm |
| Self-adhesive: | Yes |

Mounting on aluminium profiles is essential for heat dissipation.



You can find power supply units and controls from page 262 onwards.

Product advantages

- Suitable for indoor (IP00, IP60) and outdoor (IP67) applications.
- 8 LEDs per segment.
- Decorative lighting for furniture, objects and light covers.
- Length 5,000 mm with a pitch of 125 mm.
- Service life L80/B10: 123,000 hours.
- Optimum heat dissipation thanks to suitable aluminium profiles.
- Dimmable with appropriate accessories.



LED flex stripes versions

| IP00 | | Uncoated LED flex stripe for indoor use in dry areas. Cannot be wiped off with a damp cloth. | | | | | |
|----------------------|------------|--|------------|--------------|---|------------------|--------------------|
| Article no. 5,000 mm | Price in € | Article no. 125 mm | Price in € | Light colour | Luminous flux /m | EEC Spectrum A-G | Dimensions [W x H] |
| 15501027 | 99.00 | 75501027 | 3.50 | 2,700 K | 617 lm | D | 8 x 1.4 mm |
| 15501003 | 99.00 | 75501003 | 3.50 | 3,000 K | 703 lm | D | 8 x 1.4 mm |
| 15501004 | 99.00 | 75501004 | 3.50 | 4,000 K | 779 lm | C | 8 x 1.4 mm |
| | | | 75998000 | 15.90 | Assembly with degree of protection IP00 | | |

| IP60 | | Durable silicone coating, insensitive to mechanical stress, wipeable. | | | | | |
|----------------------|------------|---|------------|--------------|--|------------------|--------------------|
| Article no. 5,000 mm | Price in € | Article no. 125 mm | Price in € | Light colour | Luminous flux /m | EEC Spectrum A-G | Dimensions [W x H] |
| 15521027 | 129.00 | 75521027 | 4.60 | 2,700 K | 609 lm | D | 8 x 3 mm |
| 15521003 | 129.00 | 75521003 | 4.60 | 3,000 K | 610 lm | D | 8 x 3 mm |
| 15521004 | 129.00 | 75521004 | 4.60 | 4,000 K | 719 lm | C | 8 x 3 mm |
| | | | 75999000 | 23.90 | Assembly with increased degree of protection IP6.. | | |

| IP67 | | White, light-reflecting carrier profile with durable silicone coating. Optimum protection against mechanical stress and moisture, washable. | | | | | |
|----------------------|------------|---|------------|--------------|--|------------------|--------------------|
| Article no. 5,000 mm | Price in € | Article no. 125 mm | Price in € | Light colour | Luminous flux /m | EEC Spectrum A-G | Dimensions [W x H] |
| 15571027 | 159.00 | 75571027 | 5.65 | 2,700 K | 630 lm | D | 11 x 5 mm |
| 15571003 | 159.00 | 75571003 | 5.65 | 3,000 K | 598 lm | D | 11 x 5 mm |
| 15571004 | 159.00 | 75571004 | 5.65 | 4,000 K | 739 lm | C | 11 x 5 mm |
| | | | 75999000 | 23.90 | Assembly with increased degree of protection IP6.. | | |

The items on this page are subject to discount group 1.

QUALITYFLEX Select HE

LED flex stripe, 5 m, CRI > 90, 9.6 W / m

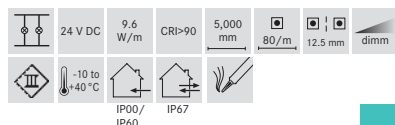
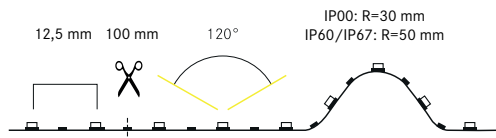

NEW

Electrical data

| | |
|-----------------------|---------------|
| LED circuit board: | SMD-LED 2835 |
| Power consumption: | 9.6 W/m |
| LED number per metre: | 80 |
| Rated voltage: | 24 V DC |
| Protection class: | III |
| Ambient temperature: | -10 to +40 °C |

Photometric data

| | |
|-------------------------|------------------------------|
| Colour rendering index: | CRI > 90 |
| Efficiency: | 145 lm/W at IP00, 3,000 K |

Photometric data

| | |
|-------------|------|
| Beam angle: | 120° |
|-------------|------|

Service life:

| | |
|---------------|--|
| Service life: | L80/B10: 123,000 h L70/B50: 181,000 h |
|---------------|--|

Mechanical data

| | |
|------------------------------|-------------------------------------|
| Length of the circuit board: | 5,000 mm |
| max. module length: | 5,000 mm |
| Pitch: | 100 mm |
| Smallest bending radius: | IP00: R=30 mm IP60/IP67: R=50 mm |
| Short pitch: | 12.5 mm |
| Connection cable: | 2 x 350 mm |
| Self-adhesive: | Yes |

Mounting on aluminium profiles is essential for heat dissipation.

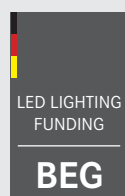

You can find power supply units and controls from page 262 onwards.

Product advantages

- Suitable for indoor (IP00, IP60) and outdoor (IP67) applications.
- 8 LEDs per segment.
- Decorative lighting for furniture, objects and light covers.
- Indirect lighting in living areas.
- Length 5,000 mm with a pitch of 100 mm.
- Available in 2,700 K, 3,000 K and 4,000 K.
- Dimmable with appropriate accessories.



LED flex stripes versions

| IP00 | | Uncoated LED flex stripe for indoor use in dry areas. Cannot be wiped off with a damp cloth. | | | | | | |
|-------------------------|---------------|--|---------------|-----------------|---|---------------------|-----------------------|--|
| Article no. 5,000 mm | Price in € | Article no. 100 mm | Price in € | Light colour | Luminous flux /m | EEC Spectrum A-G | Dimensions [W x H] | |
| 15502027 | 109.00 | 75502027 | 3.15 | 2,700 K | 1,377 lm | D | 8 x 1.4 mm | |
| 15502003 | 109.00 | 75502003 | 3.15 | 3,000 K | 1,398 lm | D | 8 x 1.4 mm | |
| 15502004 | 109.00 | 75502004 | 3.15 | 4,000 K | 1,515 lm | C | 8 x 1.4 mm | |
| | | | 75998000 | 15.90 | Assembly with degree of protection IP00 | | | |

| IP60 | | Durable silicone coating, insensitive to mechanical stress, wipeable. | | | | | | |
|-------------------------|---------------|---|---------------|-----------------|--|---------------------|-----------------------|--|
| Article no. 5,000 mm | Price in € | Article no. 100 mm | Price in € | Light colour | Luminous flux /m | EEC Spectrum A-G | Dimensions [W x H] | |
| 15522027 | 139.00 | 75522027 | 4.00 | 2,700 K | 1,201 lm | D | 8 x 3 mm | |
| 15522003 | 139.00 | 75522003 | 4.00 | 3,000 K | 1,278 lm | D | 8 x 3 mm | |
| 15522004 | 139.00 | 75522004 | 4.00 | 4,000 K | 1,381 lm | D | 8 x 3 mm | |
| | | | 75999000 | 23.90 | Assembly with increased degree of protection IP6.. | | | |

| IP67 | | White, light-reflecting carrier profile with durable silicone coating. Optimum protection against mechanical stress and moisture, washable. | | | | | | |
|-------------------------|---------------|---|---------------|-----------------|--|---------------------|-----------------------|--|
| Article no. 5,000 mm | Price in € | Article no. 100 mm | Price in € | Light colour | Luminous flux /m | EEC Spectrum A-G | Dimensions [W x H] | |
| 15572027 | 179.00 | 75572027 | 5.10 | 2,700 K | 1,213 lm | D | 11 x 5 mm | |
| 15572003 | 179.00 | 75572003 | 5.10 | 3,000 K | 1,246 lm | D | 11 x 5 mm | |
| 15572004 | 179.00 | 75572004 | 5.10 | 4,000 K | 1,495 lm | C | 11 x 5 mm | |
| | | | 75999000 | 23.90 | Assembly with increased degree of protection IP6.. | | | |

The items on this page are subject to discount group 1.

QUALITYFLEX Select HE

LED flex stripe, 5 m, CRI > 90, 14.4 W / m

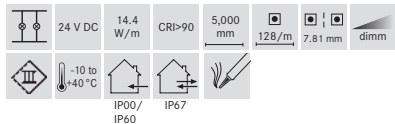
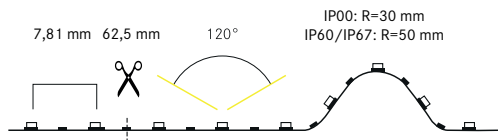

NEW

Electrical data

| | |
|-----------------------|---------------|
| LED circuit board: | SMD-LED 2835 |
| Power consumption: | 14.4 W/m |
| LED number per metre: | 128 |
| Rated voltage: | 24 V DC |
| Protection class: | III |
| Ambient temperature: | -10 to +40 °C |

Photometric data

| | |
|-------------------------|---------------------------|
| Colour rendering index: | CRI > 90 |
| Efficiency: | 149 lm/W at IP00, 3,000 K |

Photometric data

| | |
|-------------|------|
| Beam angle: | 120° |
|-------------|------|

Service life:

| | |
|---------------|--|
| Service life: | L80/B10: 123,000 h L70/B50: 181,000 h |
|---------------|--|

Mechanical data

| | |
|------------------------------|-------------------------------------|
| Length of the circuit board: | 5,000 mm |
| max. module length: | 5,000 mm |
| Pitch: | 62.5 mm |
| Smallest bending radius: | IP00: R=30 mm IP60/IP67: R=50 mm |
| Short pitch: | 7.81 mm |
| Connection cable: | 2 x 350 mm |
| Self-adhesive: | Yes |

Mounting on aluminium profiles is essential for heat dissipation.



You can find power supply units and controls from page 262 onwards.

Product advantages

- Suitable for indoor (IP00, IP60) and outdoor (IP67) applications.
- 8 LEDs per segment.
- Direct lighting of work surfaces (e.g. in the kitchen).
- Indirect lighting in living areas.
- Length 5,000 mm with a pitch of 62.5 mm.
- Available in 2,700 K, 3,000 K and 4,000 K.
- Dimmable with appropriate accessories.



LED flex stripes versions

| IP00 | | Uncoated LED flex stripe for indoor use in dry areas. Cannot be wiped off with a damp cloth. | | | | | | |
|-------------|------------|--|------------|--------------|---|------------------|--------------------|--|
| Article no. | Price in € | Article no. | Price in € | Light colour | Luminous flux / m | EEC Spectrum A-G | Dimensions [W x H] | |
| 5,000 mm | | 62.5 mm | | | | | | |
| 15503027 | 129.00 | 75503027 | 2.35 | 2,700 K | 1,980 lm | D | 10 x 1.4 mm | |
| 15503003 | 129.00 | 75503003 | 2.35 | 3,000 K | 2,159 lm | C | 10 x 1.4 mm | |
| 15503004 | 129.00 | 75503004 | 2.35 | 4,000 K | 2,277 lm | C | 10 x 1.4 mm | |
| | | | 75998000 | 15.90 | Assembly with degree of protection IP00 | | | |

| IP60 | | Durable silicone coating, insensitive to mechanical stress, wipeable. | | | | | | |
|-------------|------------|---|------------|--------------|--|------------------|--------------------|--|
| Article no. | Price in € | Article no. | Price in € | Light colour | Luminous flux / m | EEC Spectrum A-G | Dimensions [W x H] | |
| 5,000 mm | | 62.5 mm | | | | | | |
| 15523027 | 149.00 | 75523027 | 2.70 | 2,700 K | 1,891 lm | D | 10 x 3 mm | |
| 15523003 | 149.00 | 75523003 | 2.70 | 3,000 K | 1,890 lm | D | 10 x 3 mm | |
| 15523004 | 149.00 | 75523004 | 2.70 | 4,000 K | 2,036 lm | D | 10 x 3 mm | |
| | | | 75999000 | 23.90 | Assembly with increased degree of protection IP6.. | | | |

| IP67 | | White, light-reflecting carrier profile with durable silicone coating. Optimum protection against mechanical stress and moisture, washable. | | | | | | |
|-------------|------------|---|------------|--------------|--|------------------|--------------------|--|
| Article no. | Price in € | Article no. | Price in € | Light colour | Luminous flux / m | EEC Spectrum A-G | Dimensions [W x H] | |
| 5,000 mm | | 62.5 mm | | | | | | |
| 15573027 | 199.00 | 75573027 | 3.60 | 2,700 K | 1,780 lm | E | 12.5 x 5 mm | |
| 15573003 | 199.00 | 75573003 | 3.60 | 3,000 K | 1,769 lm | E | 12.5 x 5 mm | |
| 15573004 | 199.00 | 75573004 | 3.60 | 4,000 K | 1,992 lm | D | 12.5 x 5 mm | |
| | | | 75999000 | 23.90 | Assembly with increased degree of protection IP6.. | | | |

The items on this page are subject to discount group 1.

QUALITYFLEX Select HE

LED flex stripe, 5 m, CRI > 90, 19.2 W / m

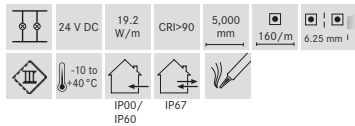
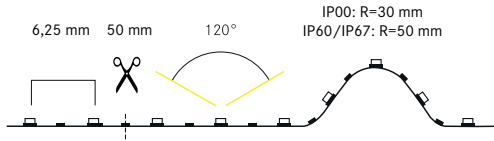

NEW

Electrical data

| | |
|-----------------------|---------------|
| LED circuit board: | SMD-LED 2835 |
| Power consumption: | 19.2 W/m |
| LED number per metre: | 160 |
| Rated voltage: | 24 V DC |
| Protection class: | III |
| Ambient temperature: | -10 to +40 °C |

Photometric data

| | |
|-------------------------|------------------------------|
| Colour rendering index: | CRI > 90 |
| Efficiency: | 146 lm/W at IP00, 3,000 K |

Photometric data

| | |
|-------------|------|
| Beam angle: | 120° |
|-------------|------|

Service life:

| | |
|---------------|--|
| Service life: | L80/B10: 123,000 h L70/B50: 181,000 h |
|---------------|--|

Mechanical data

| | |
|------------------------------|-------------------------------------|
| Length of the circuit board: | 5,000 mm |
| max. module length: | 5,000 mm |
| Pitch: | 50 mm |
| Smallest bending radius: | IP00: R=30 mm IP60/IP67: R=50 mm |
| Short pitch: | 6.25 mm |
| Connection cable: | 2 x 350 mm |
| Self-adhesive: | Yes |

Mounting on aluminium profiles is essential for heat dissipation.



You can find power supply units and controls from page 262 onwards.

Product advantages

- Suitable for indoor (IP00, IP60) and outdoor (IP67) applications.
- 8 LEDs per segment.
- Direct lighting of work surfaces (e.g. in the kitchen).
- Indirect lighting in living areas.
- Length 5,000 mm with a pitch of 50 mm.
- Available in 2,700 K, 3,000 K and 4,000 K.
- Dimmable with appropriate accessories.

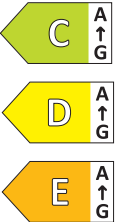

LED flex stripes versions

| IP00 | | Uncoated LED flex stripe for indoor use in dry areas. Cannot be wiped off with a damp cloth. | | | | | | |
|-------------------------|---------------|--|---------------|-----------------|---|---------------------|-----------------------|--|
| Article no. 5,000 mm | Price in € | Article no. 50 mm | Price in € | Light colour | Luminous flux /m | EEC Spectrum A-G | Dimensions [W x H] | |
| 15504027 | 149.00 | 75504027 | 2.15 | 2,700 K | 2,616 lm | D | 10 x 1.4 mm | |
| 15504003 | 149.00 | 75504003 | 2.15 | 3,000 K | 2,811 lm | D | 10 x 1.4 mm | |
| 15504004 | 149.00 | 75504004 | 2.15 | 4,000 K | 3,014 lm | C | 10 x 1.4 mm | |
| | | | 75998000 | 15.90 | Assembly with degree of protection IP00 | | | |

| IP60 | | Durable silicone coating, insensitive to mechanical stress, wipeable. | | | | | | |
|-------------------------|---------------|---|---------------|-----------------|--|---------------------|-----------------------|--|
| Article no. 5,000 mm | Price in € | Article no. 50 mm | Price in € | Light colour | Luminous flux /m | EEC Spectrum A-G | Dimensions [W x H] | |
| 15524027 | 169.00 | 75524027 | 2.45 | 2,700 K | 2,414 lm | D | 10 x 3 mm | |
| 15524003 | 169.00 | 75524003 | 2.45 | 3,000 K | 2,436 lm | D | 10 x 3 mm | |
| 15524004 | 169.00 | 75524004 | 2.45 | 4,000 K | 2,869 lm | C | 10 x 3 mm | |
| | | | 75999000 | 23.90 | Assembly with increased degree of protection IP6.. | | | |

| IP67 | | White, light-reflecting carrier profile with durable silicone coating. Optimum protection against mechanical stress and moisture, washable. | | | | | | |
|-------------------------|---------------|---|---------------|-----------------|--|---------------------|-----------------------|--|
| Article no. 5,000 mm | Price in € | Article no. 50 mm | Price in € | Light colour | Luminous flux /m | EEC Spectrum A-G | Dimensions [W x H] | |
| 15574027 | 229.00 | 75574027 | 3.30 | 2,700 K | 2,231 lm | E | 12.5 x 5 mm | |
| 15574003 | 229.00 | 75574003 | 3.30 | 3,000 K | 2,322 lm | E | 12.5 x 5 mm | |
| 15574004 | 229.00 | 75574004 | 3.30 | 4,000 K | 2,723 lm | D | 12.5 x 5 mm | |
| | | | 75999000 | 23.90 | Assembly with increased degree of protection IP6.. | | | |

The items on this page are subject to discount group 1.

QUALITYFLEX COB-Sauna

LED flex stripe, 5 m, CRI > 90, 10 W / m, IP67

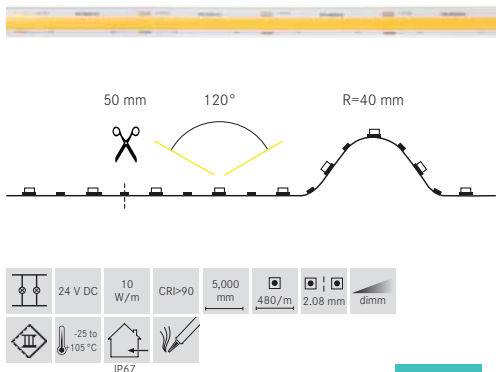

NEW

Electrical data

| | |
|-----------------------|----------------|
| LED circuit board: | COB-LED |
| Power consumption: | 10 W/m |
| LED number per metre: | 480 |
| Rated voltage: | 24 V DC |
| Protection class: | III |
| Ambient temperature: | -25 to +105 °C |

Photometric data

| | |
|-------------------------|-----------------------------|
| Colour rendering index: | CRI > 90 |
| Colour consistency: | SDCM < 5 |
| Efficiency: | 90 lm/W at IP67, 3,000 K |

Photometric data

| | |
|-------------|------|
| Beam angle: | 120° |
|-------------|------|

Service life:

| | |
|---------------|---|
| Service life: | L80/B10: 36,000 h L70/B50: 50,000 h ta. 115°C |
|---------------|---|

Mechanical data

| | |
|------------------------------|------------|
| Length of the circuit board: | 5,000 mm |
| max. module length: | 5,000 mm |
| Pitch: | 50 mm |
| Short pitch: | 2.08 mm |
| Smallest bending radius: | 40 mm |
| Connection cable: | 1 x 300 mm |
| Self-adhesive: | Yes |

You can find power supply units and controls from page 262 onwards.

Product advantages

- Mounted directly to the surface with silicone clips, 15 included.
- Continuous light emission over the length of the board.
- Ideal for use at higher ambient temperatures, steam bath/sauna.
- Colour temperature 2,700 Kelvin or 3,000 Kelvin.
- Suitable for indoor use only.
- A silicone connection cable must be used when assembling on site!
- Light colour: monochrome white.
- Dimmable with appropriate accessories.

LED flex stripes versions



IP67



Uncoated LED flex stripe for indoor use in dry areas. Cannot be wiped off with a damp cloth.

| Article no. 5,000 mm | Price in € | Light colour | Luminous flux /m | EEC Spectrum A-G | Dimensions [W x H] |
|-------------------------|---------------|--------------|---------------------|---------------------|-----------------------|
| 15666027 | 239.00 | 2,700 K | 840 lm | F | 12 x 5.5 mm |
| 15666003 | 239.00 | 3,000 K | 900 lm | F | 12 x 5.5 mm |

These items are subject to discount group 1.

QUALITYFLEX COB-Vision

LED flex stripe, 5 m, CRI > 90, 10 W / m

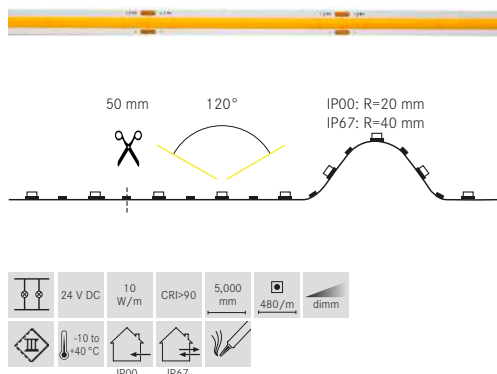

Electrical data

| | |
|-----------------------|---------------|
| LED circuit board: | COB-LED |
| Power consumption: | 10 W/m |
| LED number per metre: | 480 |
| Rated voltage: | 24 V DC |
| Protection class: | III |
| Ambient temperature: | -10 to +40 °C |

Photometric data

| | |
|-------------------------|------------------------------|
| Colour rendering index: | CRI > 90 |
| Colour consistency: | SDCM < 3 |
| Efficiency: | 100 lm/W at IP00, 3,000 K |

Photometric data

| | |
|-------------|------|
| Beam angle: | 120° |
|-------------|------|

Service life:

| | |
|---------------|--|
| Service life: | L80/B10: 30,000 h L70/B50: 52,000 h |
|---------------|--|

Mechanical data

| | |
|------------------------------|----------------------------|
| Length of the circuit board: | 5,000 mm |
| max. module length: | 5,000 mm |
| Pitch: | 50 mm |
| Smallest bending radius: | IP00: 20 mm IP67: 40 mm |
| Connection cable: | 2 x 500 mm |
| Self-adhesive: | Yes |

Mounting on aluminium profiles is essential for heat dissipation.

You can find power supply units and controls from page 262 onwards.

Product advantages

- High colour rendering with CRI > 90.
- Chip-on-board LED assembly for homogeneous light pattern.
- Continuous light emission over the length of the board.
- Ideal for indirect and decorative lighting.
- Colour temperature 2,700 K, 3,000 K, 4,000 K.
- Suitable for applications in dry indoor (IP00) and outdoor areas (IP67).
- Pitch of 50 millimetres.
- Colour temperature: monochrome white.
- Dimmable with appropriate accessories.

E A ↑ G

F A ↑ G

LED flex stripes versions

| IP00 | | Uncoated LED flex stripe for indoor use in dry areas. Cannot be wiped off with a damp cloth. | | | | | |
|-------------------------|---------------|--|-----------------|---------------------|---|-----------------------|--|
| Article no. 5,000 mm | Price in € | Article no. 50 mm | Light colour | Luminous flux /m | EEC Spectrum A-G | Dimensions [W x H] | |
| 15317027 | 169.00 | 75317027 | 3.50 2,700 K | approx. 950 lm | F | 10 x 2 mm | |
| 15317003 | 169.00 | 75317003 | 3.50 3,000 K | approx. 1,000 lm | F | 10 x 2 mm | |
| 15317004 | 169.00 | 75317004 | 3.50 4,000 K | approx. 1,105 lm | E | 10 x 2 mm | |
| | | | 75998000 | 15.90 | Assembly with degree of protection IP00 | | |

These items are subject to discount group 1.

| IP67 | | Transparent, durable silicone coating for optimum protection against mechanical stress and moisture, washable. | | | | | |
|-------------------------|---------------|--|-----------------|---------------------|--|-----------------------|--|
| Article no. 5,000 mm | Price in € | Article no. 50 mm | Light colour | Luminous flux /m | EEC Spectrum A-G | Dimensions [W x H] | |
| 15377027 | 229.00 | 75377027 | 3.70 2,700 K | approx. 870 lm | F | 12 x 5 mm | |
| 15377003 | 229.00 | 75377003 | 3.70 3,000 K | approx. 920 lm | F | 12 x 5 mm | |
| 15377004 | 229.00 | 75377004 | 3.70 4,000 K | approx. 1,030 lm | E | 12 x 5 mm | |
| | | | 75999000 | 23.90 | Assembly with increased degree of protection IP6.. | | |

The items on this page are subject to discount group 1.

QUALITYFLEX COB-Vision, TunableWhite LED flex stripe, 5 m, CRI > 90, 15 W / m

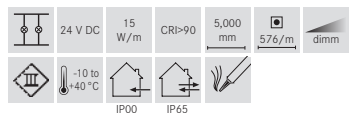
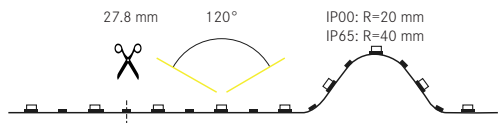
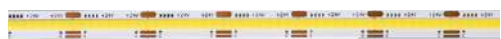

Electrical data

| | |
|-----------------------|-------------------|
| LED circuit board: | COB-LED |
| Power consumption: | 15 W/m |
| LED number per metre: | 576 |
| Rated voltage: | 24 V DC |
| Protection class: | III |
| Ambient temperature: | -10 to +40 °C |
| Control: | Negative (3-wire) |

Photometric data

| | |
|-------------------------|----------|
| Colour rendering index: | CRI > 90 |
| Colour consistency: | SDCM < 3 |

Photometric data

| | |
|-------------|------|
| Beam angle: | 120° |
|-------------|------|

Service life:

| | |
|---------------|-------------------|
| Service life: | L80/B10: 30,000 h |
| | L70/B50: 52,000 h |

Mechanical data

| | |
|------------------------------|-------------|
| Length of the circuit board: | 5,000 mm |
| max. module length: | 5,000 mm |
| Pitch: | 27.8 mm |
| Smallest bending radius: | IP00: 20 mm |
| | IP65: 40 mm |
| Connection cable: | 2 x 500 mm |
| Self-adhesive: | Yes |

Mounting on aluminium profiles is essential for heat dissipation.

You can find power supply units and controls from page 262 onwards.

Product advantages

- TunableWhite chip-on-board LED assembly for homogeneous light pattern.
- Compatible with our TunableWhite LED insert 12843004.
- Suitable for indoor (IP00) and outdoor (IP65) applications.
- Colour temperature and brightness can be changed with 2-channel dimmers.
- Optimally controllable via DALI (DT8) or TunableWhite radio remote control.
- Colour temperature: 2,000 Kelvin to 6,500 Kelvin.
- High colour rendering with CRI > 90.

LED flex stripes versions



| | | | | | | | |
|-------------------------|---------------|--|---------------|---|---------------------|---------------------|-----------------------|
| IP00 | | Uncoated LED flex stripe for indoor use in dry areas. Cannot be wiped off with a damp cloth. | | | | | |
| Article no. 5,000 mm | Price in € | Article no. 27.8 mm | Price in € | Light colour | Luminous flux /m | EEC Spectrum A-G | Dimensions [W x H] |
| 15316004 | 239.00 | 75316004 | 3.20 | 2,000 K | approx. 700 lm | F | 10 x 2 mm |
| | | | | 6,500 K | approx. 825 lm | | |
| | | 75998000 | 15.90 | Assembly with degree of protection IP00 | | | |

| | | | | | | | |
|-------------------------|---------------|--|---------------|---|---------------------|---------------------|-----------------------|
| IP65 | | Transparent, durable silicone coating for optimum protection against mechanical stress and moisture, washable. | | | | | |
| Article no. 5,000 mm | Price in € | Article no. 27.8 mm | Price in € | Light colour | Luminous flux /m | EEC Spectrum A-G | Dimensions [W x H] |
| 15376004 | 259.00 | 75376004 | 4.10 | 2,000 K | approx. 640 lm | F | 12 x 5 mm |
| | | | | 6,500 K | approx. 755 lm | | |
| | | 75999000 | 23.90 | Assembly with increased degree of protection IP65.. | | | |

The items on this page are subject to discount group 1.

QUALITYFLEX COB-Vision, RGBW LED flex stripe, 5 m, 16 W / m

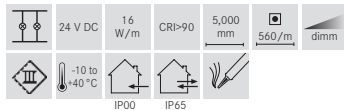
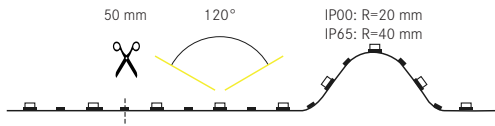

Electrical data

| | |
|-----------------------|-------------------|
| LED circuit board: | COB-LED |
| Power consumption: | 16 W/m |
| LED number per metre: | 560 |
| Rated voltage: | 24 V DC |
| Protection class: | III |
| Ambient temperature: | -10 to +40 °C |
| Control: | Negative (5-wire) |

Photometric data

| | |
|-------------------------|---------------------|
| Colour rendering index: | CRI > 90 at 3,000 K |
|-------------------------|---------------------|

Photometric data

| | |
|-------------|------|
| Beam angle: | 120° |
|-------------|------|

Service life:

| | |
|---------------|-------------------|
| Service life: | L80/B10: 30,000 h |
| | L70/B50: 52,000 h |

Mechanical data

| | |
|------------------------------|-------------|
| Length of the circuit board: | 5,000 mm |
| max. module length: | 5,000 mm |
| Pitch: | 50 mm |
| Smallest bending radius: | IP00: 20 mm |
| | IP65: 40 mm |
| Connection cable: | 2 x 500 mm |
| Self-adhesive: | Yes |

Mounting on aluminium profiles is essential for heat dissipation.

You can find power supply units and controls from page 262 onwards.

Product advantages

- Effective play of colours and white light in an LED flex stripe.
- RGBW chip-on-board LED assembly for homogeneous light pattern.
- Wide range of lighting options for coved lighting, linear applications and luminous ceilings.
- Light colours: red / green / blue / white.
- Countless mixed colours can be used.
- Suitable for indoor (IP00) and outdoor (IP65) applications.
- Compatible with our 4-channel 24 V DC controllers, RGBW.

LED flex stripes versions



| IP00 | | Uncoated LED flex stripe for indoor use in dry areas. Cannot be wiped off with a damp cloth. | | | | | |
|-------------|------------|--|------------|---|------------------|------------------|--------------------|
| Article no. | Price in € | Article no. | Price in € | Light colour | Luminous flux /m | EEC Spectrum A-G | Dimensions [W x H] |
| 18507002 | 339.00 | 75507002 | 8.80 | 3,000 K | approx. 324 lm | F | 12 x 2 mm |
| | | | | red | approx. 136 lm | | |
| | | | | green | approx. 292 lm | | |
| | | | | blue | approx. 80 lm | | |
| | | 75998000 | 15.90 | Assembly with degree of protection IP00 | | | |

| IP65 | | Transparent, durable silicone coating for optimum protection against mechanical stress and moisture, washable. | | | | | |
|-------------|------------|--|------------|---|------------------|------------------|--------------------|
| Article no. | Price in € | Article no. | Price in € | Light colour | Luminous flux /m | EEC Spectrum A-G | Dimensions [W x H] |
| 18577002 | 379.00 | 75577002 | 9.70 | 3,000 K | approx. 295 lm | F | 14 x 5 mm |
| | | | | red | approx. 125 lm | | |
| | | | | green | approx. 265 lm | | |
| | | | | blue | approx. 73 lm | | |
| | | 75999000 | 23.90 | Assembly with increased degree of protection IP65.. | | | |

The items on this page are subject to discount group 1.

ALUMINIUM PROFILES AND ACCESSORIES.

For optimum performance of the LED flex stripes.

| Article no. | Lengths | Colour | Price in € | Article no. | Colour | Price in € |
|-------------|---------|--------|------------|-------------|--------|------------|
|-------------|---------|--------|------------|-------------|--------|------------|

SURFACE-MOUNTED CORNER PROFILE P62-14

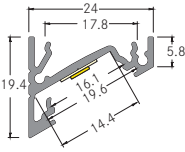

| | | | |
|----------|----------|--------------------|-------|
| 53702260 | 2,000 mm | anodised aluminium | 36.90 |
| 53702070 | 2,000 mm | white painted | 54.30 |
| 53702080 | 2,000 mm | black anodised | 54.30 |

End cap set Profile



| | | |
|----------|--------|------|
| 53073260 | silver | 3.30 |
| 53073070 | white | 3.30 |
| 53073080 | black | 3.30 |

End cap set Cover for 53432...



| | | |
|----------|-----|------|
| 53056070 | pal | 4.90 |
|----------|-----|------|

Consisting of 2 end caps.

ACCESSORIES

Bracket set

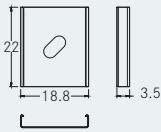
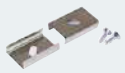

| Article no. | Colour | Price in € |
|-------------|--------|------------|
| 53003000 | silver | 5.30 |

Consisting of 2 brackets.

Connector 180°

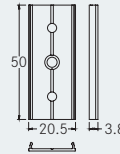

| Article no. | Colour | Price in € |
|-------------|---------------|------------|
| 53004000 | aluminium raw | 4.20 |

PLASTIC COVER

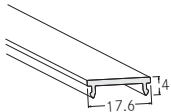

Article no.: 53402...
Flush cover

| Article no. | Lengths | Colour | Price in € |
|-------------|----------|-------------|------------|
| 53402000 | 2,000 mm | transparent | 22.70 |
| 53402070 | 2,000 mm | opal | 22.70 |
| 53402080 | 2,000 mm | black | 22.70 |
| 53432070 | 2,000 mm | opal | 50.10 |

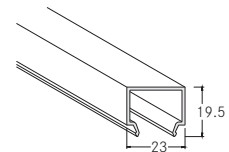

Article no.: 53432070
Height offset cover

| Article no. | Lengths | Colour | Price in € | Article no. | Colour | Price in € |
|-------------|---------|--------|------------|-------------|--------|------------|
|-------------|---------|--------|------------|-------------|--------|------------|

MOUNTING PROFILE P06-20

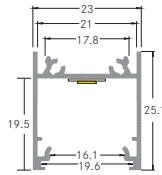

| | | | |
|----------|----------|--------------------|-------|
| 53603260 | 2,000 mm | anodised aluminium | 36.80 |
| 53603070 | 2,000 mm | white painted | 57.10 |
| 53603080 | 2,000 mm | black anodised | 57.10 |

End cap set Profile



| | | |
|----------|--------|------|
| 53057260 | silver | 4.10 |
| 53057070 | white | 4.10 |
| 53057080 | black | 4.10 |

End cap set Cover for 53432...



| | | |
|---------------------------|------|------|
| 53056070 | opal | 4.90 |
| Consisting of 2 end caps. | | |

ACCESSORIES

Bracket set

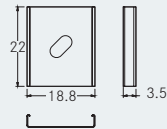

| Article no. | Colour | Price in € |
|-------------|--------|------------|
| 53003000 | silver | 5.30 |

Consisting of 2 brackets.

Connector 180°



| Article no. | Colour | Price in € |
|-------------|-----------------------------|------------|
| 53007000 | aluminium raw + transparent | 11.50 |

Rear cover plate



In conjunction with Cable suspension 53006000.

Slide-in mounting.

| Article no. | Length | Colour | Price in € |
|-------------|----------|--------------------|------------|
| 53756260 | 2,000 mm | anodised aluminium | 20.20 |
| 53756070 | 2,000 mm | white painted | 25.20 |
| 53756080 | 2,000 mm | black anodised | 26.80 |

Cable suspension set, 1,500 mm

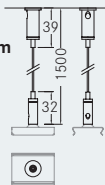

| Article no. | Colour | Price in € |
|-------------|--------|------------|
| 53006000 | chrome | 43.50 |

Cable thickness: 1 mm
Incl. 2 pieces

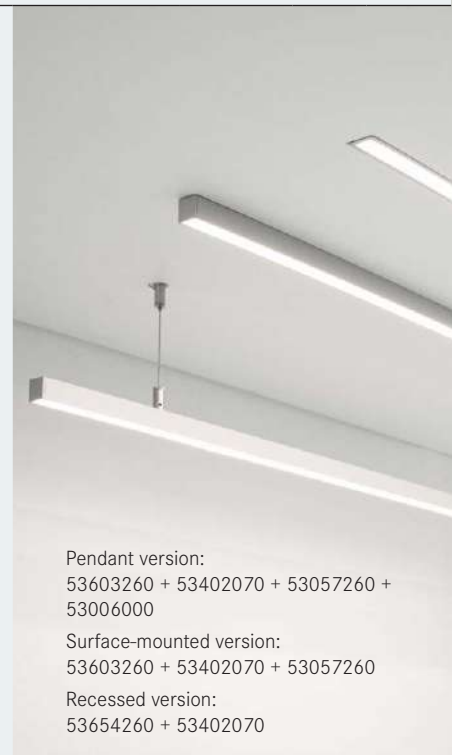

Pendant version:

53603260 + 53402070 + 53057260 + 53006000

Surface-mounted version:

53603260 + 53402070 + 53057260

Recessed version:

53654260 + 53402070

PLASTIC COVER

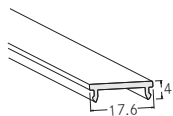

Article no.: 53402...
Flush cover

Transmittance 53402:
transparent 95%,
opal 70%, black 40%

Transmittance 53432: 70%

| Article no. | Lengths | Colour | Price in € |
|-------------|----------|-------------|------------|
| 53402000 | 2,000 mm | transparent | 22.70 |
| 53402070 | 2,000 mm | opal | 22.70 |
| 53402080 | 2,000 mm | black | 22.70 |
| 53432070 | 2,000 mm | opal | 50.10 |

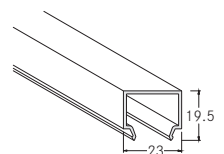

Article no.: 53432070
Height offset cover

| | Article no. | Lengths | Colour | Price in € | | Article no. | Colour | Price in € |
|--|-------------|---------|--------|------------|--|-------------|--------|------------|
|--|-------------|---------|--------|------------|--|-------------|--------|------------|

RECESSED PROFILE P36-20

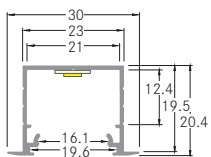

| | | | |
|----------|----------|--------------------|-------|
| 53654260 | 2,000 mm | anodised aluminium | 40.30 |
| 53654070 | 2,000 mm | white painted | 45.30 |
| 53654080 | 2,000 mm | black anodised | 45.30 |

End cap set Profile



| | | |
|----------|--------|------|
| 53066260 | silver | 4.90 |
| 53066070 | white | 4.90 |
| 53066080 | black | 4.90 |

End cap set Cover for 53432...



| | | |
|----------|------|------|
| 53056070 | Opal | 4.90 |
|----------|------|------|

Consisting of 2 end caps.

ACCESSORIES

Bracket set

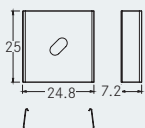
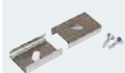

| Article no. | Colour | Price in € |
|-------------|--------|------------|
| 53010000 | silver | 6.30 |

Consisting of 2 brackets.

Connector 180°



| Article no. | Colour | Price in € |
|-------------|-----------|------------|
| 53013000 | aluminium | 14.90 |

Spring holder set for hollow ceilings

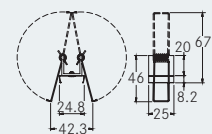

| Article no. | Colour | Price in € |
|-------------|---------------|------------|
| 53012000 | aluminium raw | 17.90 |

Consisting of 2 brackets.

PLASTIC COVER

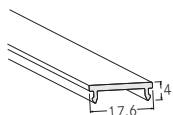

Article no.: 53402...
Flush cover

Transmittance 53402:
transparent 95%,
opal 70%, black 40%

Transmittance 53432: 70%

| Article no. | Lengths | Colour | Price in € |
|-------------|----------|-------------|------------|
| 53402000 | 2,000 mm | transparent | 22.70 |
| 53402070 | 2,000 mm | opal | 22.70 |
| 53402080 | 2,000 mm | black | 22.70 |
| 53432070 | 2,000 mm | opal | 50.10 |

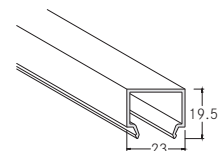

Article no.: 53432070
Height offset cover



QUALITYFLEX Protection Vertical LED flex stripe, CRI > 90, 5 W/m, IP67

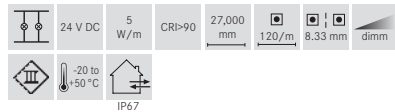
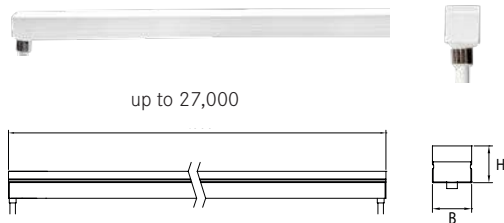

NEW

Electrical data

| | |
|-----------------------|---------------|
| LED circuit board: | SMD-LED 2835 |
| Power consumption: | 5 W/m |
| LED number per metre: | 120 |
| Rated voltage: | 24 V DC |
| Protection class: | III |
| Ambient temperature: | -20 to +50 °C |

Photometric data

| | |
|-------------------------|-----------------------------|
| Colour rendering index: | CRI > 90 |
| Colour consistency: | SDCM < 2 |
| Efficiency: | 47 lm/W at IP67, 3,000 K |

Photometric data

| | |
|-------------|------|
| Beam angle: | 120° |
|-------------|------|

Service life:

| | |
|---------------|--|
| Service life: | L80/B10: 36,000 h L70/B50: 54,000 h |
|---------------|--|

Mechanical data

| | |
|------------------------------|-------------------|
| Length of the circuit board: | 5 m, 10 m, 27 m |
| max. module length: | 27,000 mm |
| Pitch: | 50 mm |
| Smallest bending radius: | 120 mm |
| Short pitch: | 8.33 mm |
| Connection cable: | 1,000 mm |
| Self-adhesive: | No |
| Feeding: | One-sided, bottom |

If the LED flex stripe is shortened and the end cap set 53253000 is used, degree of protection IP65 is achieved on site.

* Not resistant to chlorine gas, therefore must not be used in swimming pools.

Product advantages

- Suitable for indoor and outdoor (IP67) applications.
- Divisible every 50 mm (degree of protection IP65).
- UV-protected.
- Ideal for terraces, façades and entrance areas.*
- Length 27,000 mm on a roll with a pitch of 50 mm.
- Service life L80/B10: 36,000 hours.
- Simple installation with suitable aluminium profiles or fastening clips.
- Dimmable with appropriate accessories.

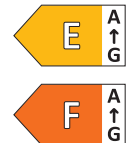

LED flex stripes versions



| IP67 | | Article no. | Price in € | Light colour | Luminous flux / m | EEC Spectrum A-G | Dimensions [W x H] |
|----------|-----|-------------|------------|--------------|-------------------|------------------|--------------------|
| | | 5,000 mm | | | | | |
| 19581527 | NEW | 725.00 | 2,700 K | 226 lm | F | 16 x 15 mm | |
| 19581503 | NEW | 725.00 | 3,000 K | 236 lm | E | 16 x 15 mm | |
| 19581504 | NEW | 725.00 | 4,000 K | 232 lm | E | 16 x 15 mm | |

| Article no. | Price in € | Light colour | Luminous flux / m | EEC Spectrum A-G | Dimensions [W x H] |
|-------------|------------|--------------|-------------------|------------------|--------------------|
| 10,000 mm | | | | | |
| 19581127 | NEW | 1439.00 | 2,700 K | 226 lm | F 16 x 15 mm |
| 19581103 | NEW | 1439.00 | 3,000 K | 236 lm | E 16 x 15 mm |
| 19581104 | NEW | 1439.00 | 4,000 K | 232 lm | E 16 x 15 mm |

| Article no. | Price in € | Light colour | Luminous flux / m | EEC Spectrum A-G | Dimensions [W x H] |
|-------------|------------|--------------|-------------------|------------------|--------------------|
| 27,000 mm | | | | | |
| 19581027 | 3850.00 | 2,700 K | 226 lm | F | 16 x 15 mm |
| 19581003 | 3850.00 | 3,000 K | 236 lm | E | 16 x 15 mm |
| 19581004 | 3850.00 | 4,000 K | 232 lm | E | 16 x 15 mm |

| Article no. | Price in € | Light colour | Luminous flux / m | EEC Spectrum A-G | Dimensions [W x H] |
|-------------|------------|---------------------------------|-------------------|------------------|--------------------|
| 50 mm | | | | | |
| 76581027 | 12.00 | 2,700 K | 226 lm | F | 16 x 15 mm |
| 76581003 | 12.00 | 3,000 K | 236 lm | E | 16 x 15 mm |
| 76581004 | 12.00 | 4,000 K | 232 lm | E | 16 x 15 mm |
| 76999000 | 229.90 | Assembly Series Protection IP67 | | | |

| IP65 | | Article no. | Price in € | Light colour | Luminous flux / m | EEC Spectrum A-G | Dimensions [W x H] |
|----------|-----|-------------|---|--------------|-------------------|------------------|--------------------|
| | | 50 mm | | | | | |
| 75581027 | NEW | 12.00 | 2,700 K | 226 lm | F | 16 x 15 mm | |
| 75581003 | NEW | 12.00 | 3,000 K | 236 lm | E | 16 x 15 mm | |
| 75581004 | NEW | 12.00 | 4,000 K | 232 lm | E | 16 x 15 mm | |
| 75999000 | NEW | 23.90 | Assembly with increased degree of protection IP65 | | | | |

The items on this page are subject to discount group 1.



Accessories overview

Vertical mounting profile



| Article no.: | Price in € | Colour: | Material: | Dimensions L x W x H: | Description: |
|--------------|------------|--------------------|-----------|------------------------|--|
| 53580260 | 18.50 | anodised aluminium | aluminium | 1,000 x 20.5 x 17.6 mm | High mounting profile for QUALITYFLEX Protection Vertical, delivery length: 1 metre in one piece, straight lines |

Vertical bracket set



| Article no.: | Price in € | Colour: | Material: | Dimensions L x W x H: | Description: |
|--------------|------------|---------|-----------|-----------------------|--|
| 53258000 | 13.00 | silver | steel | 20 x 16.6 x 12.4 mm | Fastening clip set for QUALITYFLEX Protection Vertical for fastening at radii, incl. 3 x clip and 3 x screw, 3 retaining clips must be fitted per 0.5 metre. |

Vertical feedings



| Article no.: | Price in € | Colour: | Material: | Dimensions L x W x H: | Description: |
|--------------|------------|-------------|-----------|-----------------------|-------------------------------|
| 53250100 | 9.00 | transparent | plastic | 27.9 x 20.4 x 19.4 mm | Front connection set, 2-wire |
| 53250200 | | transparent | plastic | 27.9 x 20.4 x 19.4 mm | Right connection set, 2-wire |
| 53250300 | | transparent | plastic | 27.9 x 20.4 x 19.4 mm | Bottom connection set, 2-wire |

Consisting of 1 piece each, connection piece incl. cable, holder, seal and lock, max. length: 20 metres (with degree of protection IP65)

Vertical end cap set



| Article no.: | Price in € | Colour: | Material: | Dimensions L x W x H: | Description: |
|--------------|------------|-------------|-----------|-----------------------|--|
| 53253000 | 6.00 | transparent | plastic | 27.9 x 20.4 x 19.4 mm | End cap set for QUALITYFLEX Protection Vertical (with degree of protection IP65) |

QUALITYFLEX Protection cutting tool



| Article no.: | Price in € | Description: |
|--------------|------------|---|
| 81106000 | 89.90 | Special lengths can be realised independently on site using the cutting tool and the corresponding feeding and end cap set. Alternatively, we offer this service directly at our premises. On request, we can guarantee short delivery times. |

Power supply units and controls



schaltbar

Art. no. 17244000
LED power supply unit 24 V DC,
150 W, switchable
 For operation up to 5,000 mm



dimmbar

Art. no. 17528000
White light radio control
 for controlling single-colour LED
 modules in the white light range

You can find more power supply units and control units from page 262 onwards.

QUALITYFLEX Protection Vertical, TunableWhite LED flex stripe, CRI > 90, 16 W/m, IP67

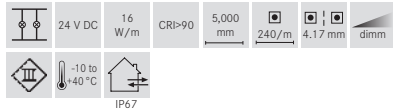
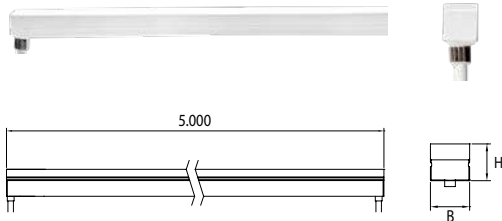

NEW

Electrical data

| | |
|-----------------------|-------------------|
| LED circuit board: | SMD-LED 3014 |
| Power consumption: | 16 W/m |
| LED number per metre: | 240 |
| Rated voltage: | 24 V DC |
| Protection class: | III |
| Ambient temperature: | -20 to +40 °C |
| Control: | Negative (3-wire) |

Photometric data

| | |
|-------------------------|----------|
| Colour rendering index: | CRI > 90 |
| Colour consistency: | SDCM < 3 |

Photometric data

| | |
|-------------|------|
| Beam angle: | 120° |
|-------------|------|

Service life:

| | |
|---------------|--|
| Service life: | L80/B10: 36,000 h L70/B50: 54,000 h |
|---------------|--|

Mechanical data

| | |
|------------------------------|-------------------|
| Length of the circuit board: | 5,000 mm |
| max. module length: | 5,000 mm |
| Pitch: | 50 mm |
| Smallest bending radius: | 120 mm |
| Short pitch: | 4.17 mm |
| Connection cable: | 1,000 mm |
| Self-adhesive: | No |
| Feeding: | One-sided, bottom |

If the LED flex stripe is shortened and the end cap set 53253000 is used, degree of protection IP65 is achieved on site.

* Not resistant to chlorine gas, therefore must not be used in swimming pools.

Product advantages

- Suitable for indoor and outdoor (IP67) applications.
- Divisible every 50 mm (degree of protection IP65).
- UV-protected.
- Ideal for terraces, façades and entrance areas.*
- Colour temperature: 2,000 K to 6,500 K.
- Service life L80/B10: 36,000 hours.
- Simple installation with suitable aluminium profiles or fastening clips.
- Dimmable with appropriate accessories.

LED flex stripes versions



| IP67 | | | | | |
|-------------|------------|--------------|------------------|------------------|--------------------|
| Article no. | Price in € | Light colour | Luminous flux /m | EEC Spectrum A-G | Dimensions [W x H] |
| 19591004 | 1050.00 | 2,000 K | 285 lm | F | 16 x 15 mm |
| | | 6,500 K | 364 lm | | |

| IP65 | | | | | |
|-------------|------------|---------------------------------|------------------|------------------|--------------------|
| Article no. | Price in € | Light colour | Luminous flux /m | EEC Spectrum A-G | Dimensions [W x H] |
| 76591004 | 17.40 | 2,000 K | 285 lm | F | 16 x 15 mm |
| | | 6,500 K | 364 lm | | |
| 76999000 | 229.90 | Assembly Series Protection IP67 | | | |

| IP65 | | | | | |
|-------------|------------|---|------------------|------------------|--------------------|
| Article no. | Price in € | Light colour | Luminous flux /m | EEC Spectrum A-G | Dimensions [W x H] |
| 75591004 | NEW 17.40 | 2,000 K | 285 lm | F | 16 x 15 mm |
| | | 6,500 K | 364 lm | | |
| 75999000 | 23.90 | Assembly with increased degree of protection IP65 | | | |

The items on this page are subject to discount group 1.

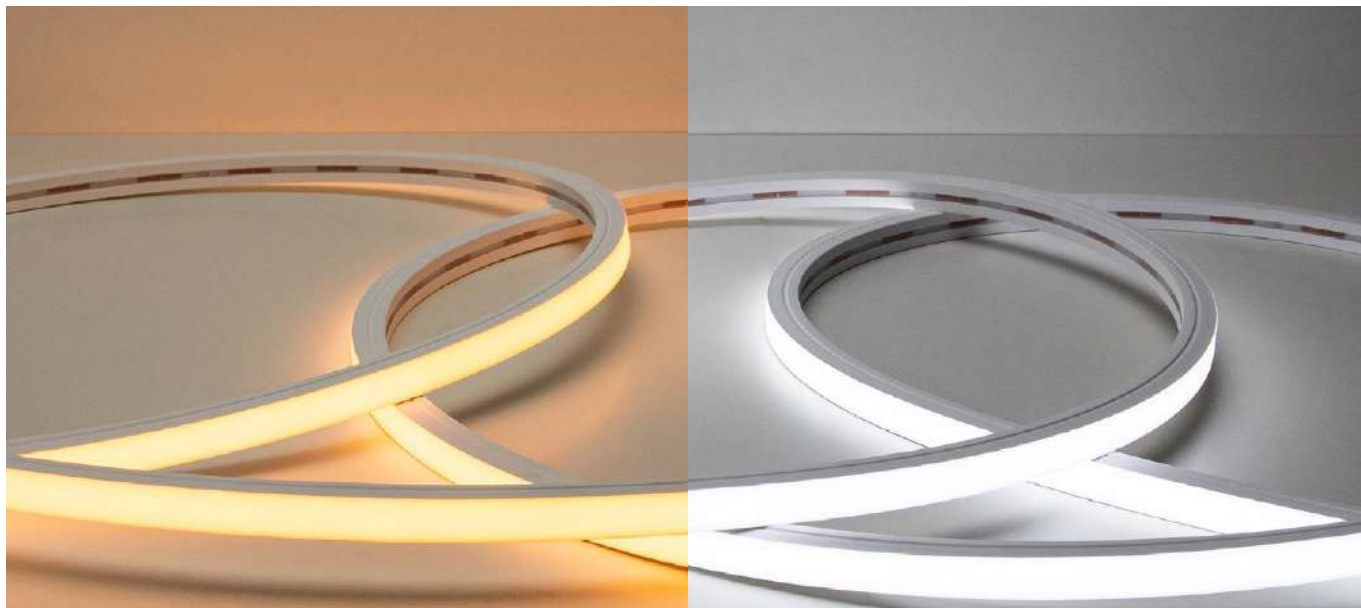

Accessories overview

Vertical mounting profile



| Article no.: | Price in € | Colour: | Material: | Dimensions L x W x H: | Description: |
|--------------|------------|--------------------|-----------|------------------------|--|
| 53580260 | 18.50 | anodised aluminium | aluminium | 1,000 x 20.5 x 17.6 mm | High mounting profile for QUALITYFLEX Protection Vertical, delivery length: 1 metre in one piece, straight lines |

Vertical bracket set



| Article no.: | Price in € | Colour: | Material: | Dimensions L x W x H: | Description: |
|--------------|------------|---------|-----------|-----------------------|--|
| 53258000 | 13.00 | silver | steel | 20 x 16.6 x 12.4 mm | Fastening clip set for QUALITYFLEX Protection Vertical for fastening at radii, incl. 3 x clip and 3 x screw, 3 retaining clips must be fitted per 0.5 metre. |

Vertical feedings



| Article no.: | Price in € | Colour: | Material: | Dimensions L x W x H: | Description: |
|--------------|------------|-------------|-----------|-----------------------|-------------------------------|
| 53251100 | 10.00 | transparent | plastic | 27.9 x 20.4 x 19.4 mm | Front connection set, 3-wire |
| 53251200 | | transparent | plastic | 27.9 x 20.4 x 19.4 mm | Right connection set, 3-wire |
| 53251300 | | transparent | plastic | 27.9 x 20.4 x 19.4 mm | Bottom connection set, 3-wire |

Consisting of 1 piece each, connection piece incl. cable, holder, seal and lock, max. length: 5 metres (with degree of protection IP65)

Vertical end cap set



| Article no.: | Price in € | Colour: | Material: | Dimensions L x W x H: | Description: |
|--------------|------------|-------------|-----------|-----------------------|--|
| 53253000 | 6.00 | transparent | plastic | 27.9 x 20.4 x 19.4 mm | End cap set for QUALITYFLEX Protection Vertical (with degree of protection IP65) |

QUALITYFLEX Protection cutting tool



| Article no.: | Price in € | Description: |
|--------------|------------|---|
| 81106000 | 89.90 | Special lengths can be realised independently on site using the cutting tool and the corresponding feeding and end cap set. Alternatively, we offer this service directly at our premises. On request, we can guarantee short delivery times. |

Power supply units and controls



schaltbar

Art. no. 17243000
LED power supply unit 24 V DC,
120 W, switchable
For operation up to 5,000 mm



dimmbar

Art. no. 18155000
LED dimmer 12-24 V DC,
DALI (DT8), dimmable
For operation up to 5,000 mm



dimmbar

Art. no. 17518000
TunableWhite radio control
for two-colour LED modules in the
white light range

**You can find more
power supply units and
control units from
page 262 onwards.**

QUALITYFLEX Protection Vertical, RGBW LED flex stripe, CRI > 80, 15 W/m, IP67

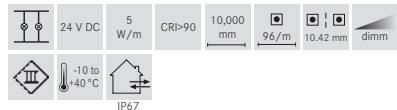
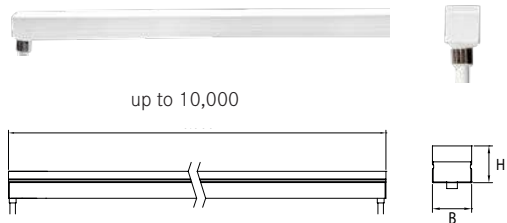

NEW

Electrical data

| | |
|-----------------------|-------------------|
| LED circuit board: | SMD-LED 5050 |
| Power consumption: | 15 W/m |
| LED number per metre: | 96 |
| Rated voltage: | 24 V DC |
| Protection class: | III |
| Ambient temperature: | -20 to +40 °C |
| Control: | Negative (5-wire) |

Photometric data

| | |
|-------------------------|---------------------|
| Colour rendering index: | CRI > 80 at 2,700 K |
|-------------------------|---------------------|

Photometric data

| | |
|-------------|------|
| Beam angle: | 120° |
|-------------|------|

Service life:

| | |
|---------------|--|
| Service life: | L80/B10: 36,000 h L70/B50: 54,000 h |
|---------------|--|

Mechanical data

| | |
|------------------------------|-------------------|
| Length of the circuit board: | 5 m, 10 m |
| max. module length: | 10,000 mm |
| Pitch: | 125 mm |
| Smallest bending radius: | 120 mm |
| Short pitch: | 10.42 mm |
| Connection cable: | 1,000 mm |
| Self-adhesive: | No |
| Feeding: | One-sided, bottom |

If the LED flex stripe is shortened and the end cap set 53253000 is used, degree of protection IP65 is achieved on site.

* Not resistant to chlorine gas, therefore must not be used in swimming pools.

Product advantages

- Suitable for indoor and outdoor (IP67) applications.
- Divisible every 125 mm (degree of protection IP65).
- UV-protected.
- Ideal for terraces, façades and entrance areas.*
- Light colours: red / green / blue / white (colour temperature: 2,700 K, CRI > 80)
- Service life L80/B10: 36,000 hours.
- Simple installation with suitable aluminium profiles or fastening clips.
- Dimmable with appropriate accessories.

LED flex stripes versions



| IP67 | | | | | |
|-------------|------------|---|------------------|------------------|--------------------|
| Article no. | Price in € | Light colour | Luminous flux /m | EEC Spectrum A-G | Dimensions [W x H] |
| 19601502 | 730.00 | 2,700 K | approx. 205 lm | F | 16 x 15 mm |
| | | red | approx. 63 lm | | |
| | | green | approx. 192 lm | | |
| | | blue | approx. 57 lm | | |
| IP65 | | | | | |
| Article no. | Price in € | Light colour | Luminous flux /m | EEC Spectrum A-G | Dimensions [W x H] |
| 19601002 | 1480.00 | 2,700 K | approx. 205 lm | F | 16 x 15 mm |
| | | red | approx. 63 lm | | |
| | | green | approx. 192 lm | | |
| | | blue | approx. 57 lm | | |
| 76601002 | 31.30 | 2,700 K | approx. 205 lm | F | 16 x 15 mm |
| | | red | approx. 63 lm | | |
| | | green | approx. 192 lm | | |
| | | blue | approx. 57 lm | | |
| 76999000 | 229.90 | Assembly Series Protection IP67 | | | |
| IP65 | | | | | |
| Article no. | Price in € | Light colour | Luminous flux /m | EEC Spectrum A-G | Dimensions [W x H] |
| 75601002 | 31.30 | 2,700 K | approx. 205 lm | F | 16 x 15 mm |
| | | red | approx. 63 lm | | |
| | | green | approx. 192 lm | | |
| | | blue | approx. 57 lm | | |
| 75999000 | 23.90 | Assembly with increased degree of protection IP65 | | | |

The items on this page are subject to discount group 1.

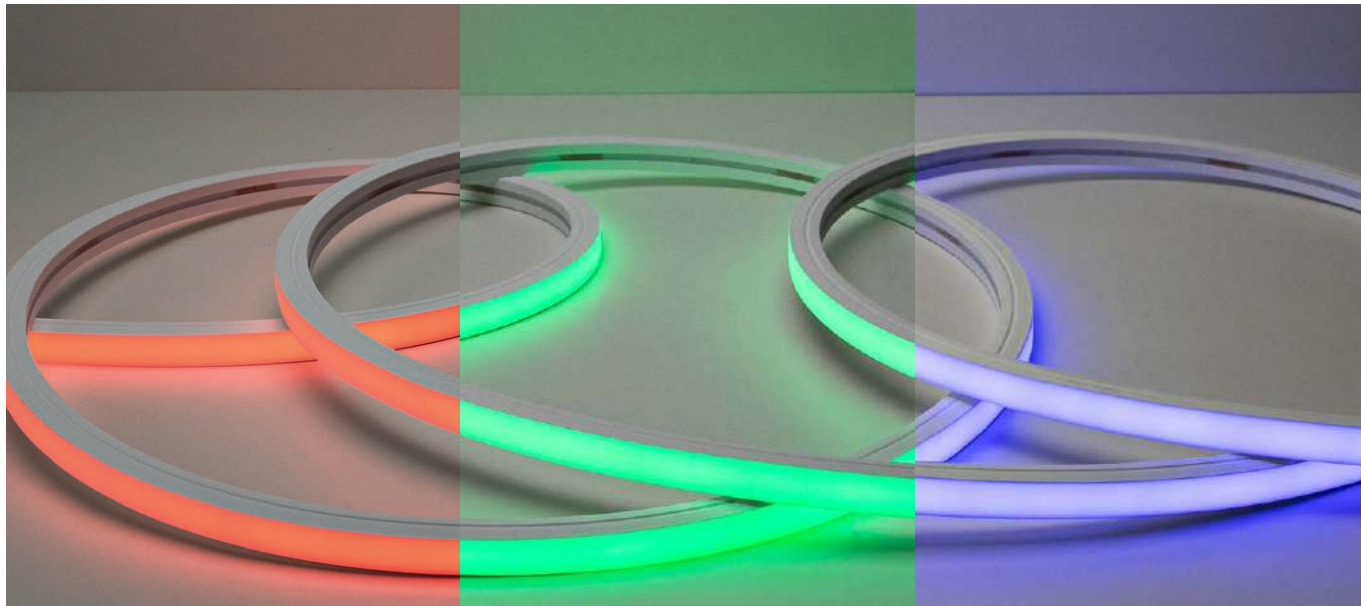

Accessories overview

Vertical mounting profile



| Article no.: | Price in € | Colour: | Material: | Dimensions L x W x H: | Description: |
|--------------|------------|--------------------|-----------|------------------------|--|
| 53580260 | 18.50 | anodised aluminium | aluminium | 1,000 x 20.5 x 17.6 mm | High mounting profile for QUALITYFLEX Protection Vertical, delivery length: 1 metre in one piece, straight lines |

Vertical bracket set



| Article no.: | Price in € | Colour: | Material: | Dimensions L x W x H: | Description: |
|--------------|------------|---------|-----------|-----------------------|--|
| 53258000 | 13.00 | silver | steel | 20 x 16.6 x 12.4 mm | Fastening clip set for QUALITYFLEX Protection Vertical for fastening at radii, incl. 3 x clip and 3 x screw, 3 retaining clips must be fitted per 0.5 metre. |

Vertical feedings



| Article no.: | Price in € | Colour: | Material: | Dimensions L x W x H: | Description: |
|--------------|------------|-------------|-----------|-----------------------|---|
| 53252100 | 12.00 | transparent | plastic | 27.9 x 20.4 x 19.4 mm | Front connection set, 5-wire |
| 53252200 | | transparent | plastic | 27.9 x 20.4 x 19.4 mm | Right connection set, 5-wire |
| 53252300 | | transparent | plastic | 27.9 x 20.4 x 19.4 mm | Bottom connection set, 5-wire |
| | | | | | Consisting of 1 piece each, connection piece incl. cable, holder, seal and lock, max. length: 4.8 metres (with degree of protection IP65) |

Vertical end cap set



| Article no.: | Price in € | Colour: | Material: | Dimensions L x W x H: | Description: |
|--------------|------------|-------------|-----------|-----------------------|--|
| 53253000 | 6.00 | transparent | plastic | 27.9 x 20.4 x 19.4 mm | End cap set for QUALITYFLEX Protection Vertical (with degree of protection IP65) |

QUALITYFLEX Protection cutting tool



| Article no.: | Price in € | Description: |
|--------------|------------|---|
| 81106000 | 89.90 | Special lengths can be realised independently on site using the cutting tool and the corresponding feeding and end cap set. Alternatively, we offer this service directly at our premises. On request, we can guarantee short delivery times. |

Power supply units and controls



schaltbar

Art. no. 17244000
LED power supply unit 24 V DC,
150 W, switchable
 For operation up to 5,000 mm



dimmbar

Art. no. 18223000
RGBW radio control
 for controlling RGBW LED
 modules for colour and white light.

**You can find more
 power supply units and
 control units
 from page 262 onwards.**

QUALITYFLEX Protection Horizon

LED flex stripe, CRI > 90, 5 W/m, IP67

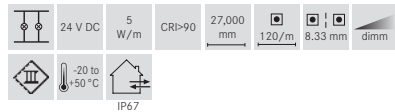
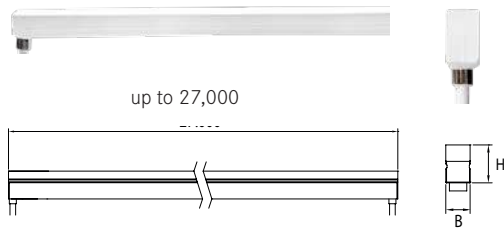

NEW

Electrical data

| | |
|-----------------------|---------------|
| LED circuit board: | SMD-LED 2835 |
| Power consumption: | 5 W/m |
| LED number per metre: | 120 |
| Rated voltage: | 24 V DC |
| Protection class: | III |
| Ambient temperature: | -20 to +50 °C |

Photometric data

| | |
|-------------------------|--------------------------|
| Colour rendering index: | CRI > 90 |
| Colour consistency: | SDCM < 2 |
| Efficiency: | 31 lm/W at IP67, 3,000 K |

Photometric data

| | |
|-------------|------|
| Beam angle: | 120° |
|-------------|------|

Service life:

| | |
|---------------|--|
| Service life: | L80/B10: 36,000 h L70/B50: 54,000 h |
|---------------|--|

Mechanical data

| | |
|------------------------------|-------------------|
| Length of the circuit board: | 5 m, 10 m, 27 m |
| max. module length: | 27,000 mm |
| Pitch: | 50 mm |
| Smallest bending radius: | 120 mm |
| Short pitch: | 8.33 mm |
| Connection cable: | 1,000 mm |
| Self-adhesive: | No |
| Feeding: | One-sided, bottom |

If the LED flex stripe is shortened and the end cap set 53254000 is used, degree of protection IP65 is achieved on site.

* Not resistant to chlorine gas, therefore must not be used in swimming pools.

Product advantages

- Suitable for indoor and outdoor (IP67) applications.
- Divisible every 50 mm (degree of protection IP65).
- UV-protected.
- Ideal for terraces, façades and entrance areas.*
- Length 27,000 mm on a roll with a pitch of 50 mm.
- Service life L80/B10: 36,000 hours.
- Simple installation with suitable aluminium profiles or fastening clips.
- Dimmable with appropriate accessories.

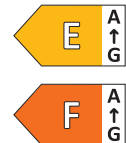

LED flex stripes versions



| IP67 | | Article no. | Price in € | Light colour | Luminous flux /m | EEC Spectrum A-G | Dimensions [W x H] |
|------|--|-------------|------------|--------------|------------------|------------------|--------------------|
| | | 5,000 mm | | | | | |
| | | 19582527 | NEW 728.00 | 2,700 K | 146 lm | F | 12 x 20 mm |
| | | 19582503 | NEW 728.00 | 3,000 K | 156 lm | E | 12 x 20 mm |
| | | 19582504 | NEW 728.00 | 4,000 K | 150 lm | E | 12 x 20 mm |

| Article no. | Price in € | Light colour | Luminous flux /m | EEC Spectrum A-G | Dimensions [W x H] |
|-------------|-------------|--------------|------------------|------------------|--------------------|
| 19582127 | NEW 1445.00 | 2,700 K | 146 lm | F | 12 x 20 mm |
| 19582103 | NEW 1445.00 | 3,000 K | 156 lm | E | 12 x 20 mm |
| 19582104 | NEW 1445.00 | 4,000 K | 150 lm | E | 12 x 20 mm |

| Article no. | Price in € | Light colour | Luminous flux /m | EEC Spectrum A-G | Dimensions [W x H] |
|-------------|------------|--------------|------------------|------------------|--------------------|
| 19582027 | 3865.00 | 2,700 K | 146 lm | F | 12 x 20 mm |
| 19582003 | 3865.00 | 3,000 K | 156 lm | E | 12 x 20 mm |
| 19582004 | 3865.00 | 4,000 K | 150 lm | E | 12 x 20 mm |

| Article no. | Price in € | Light colour | Luminous flux /m | EEC Spectrum A-G | Dimensions [W x H] |
|-------------|------------|---------------------------------|------------------|------------------|--------------------|
| 76582027 | 12.00 | 2,700 K | 146 lm | F | 12 x 20 mm |
| 76582003 | 12.00 | 3,000 K | 156 lm | E | 12 x 20 mm |
| 76582004 | 12.00 | 4,000 K | 150 lm | E | 12 x 20 mm |
| 76999000 | 229.90 | Assembly Series Protection IP67 | | | |

| IP65 | | Article no. | Price in € | Light colour | Luminous flux /m | EEC Spectrum A-G | Dimensions [W x H] |
|------|--|-------------|------------|---|------------------|------------------|--------------------|
| | | 50 mm | | | | | |
| | | 75582027 | NEW 12.00 | 2,700 K | 146 lm | F | 12 x 20 mm |
| | | 75582003 | NEW 12.00 | 3,000 K | 156 lm | E | 12 x 20 mm |
| | | 75582004 | NEW 12.00 | 4,000 K | 150 lm | E | 12 x 20 mm |
| | | 75999000 | 23.90 | Assembly with increased degree of protection IP65 | | | |

The items on this page are subject to discount group 1.



Accessories overview

Horizon mounting profile



| Article no.: | Price in € | Colour: | Material: | Dimensions L x W x H: | Description: |
|--------------|------------|--------------------|-----------|------------------------|---|
| 53581260 | 20.50 | anodised aluminium | aluminium | 1,000 x 17.5 x 22.9 mm | High mounting profile for QUALITYFLEX Protection Horizon, delivery length: 1 metre in one piece, straight lines |

Horizon special profile



| Article no.: | Price in € | Colour: | Material: | Dimensions L x W x H: | Description: |
|--------------|------------|---------|-----------------|-----------------------|---|
| 53582260 | 23.20 | silver | stainless steel | 500 x 13.5 x 18 mm | Bendable profile for QUALITYFLEX Protection Horizon, for optimum fastening at radii |

Horizon bracket set



| Article no.: | Price in € | Colour: | Material: | Dimensions L x W x H: | Description: |
|--------------|------------|---------|-----------|-----------------------|---|
| 53259000 | 13.00 | silver | steel | 20 x 12.6 x 18.9 mm | Fastening clip set for QUALITYFLEX Protection Horizon for fastening at radii, incl. 3 x clip and 3 x screw, 3 retaining clips must be fitted per 0.5 metre. |

Horizon feedings



| Article no.: | Price in € | Colour: | Material: | Dimensions L x W x H: | Description: |
|--------------|------------|-------------|-----------|-----------------------|-------------------------------|
| 53255100 | 9.00 | transparent | plastic | 26.5 x 17 x 24.2 mm | Front connection set, 2-wire |
| 53255200 | | transparent | plastic | 26.5 x 17 x 24.2 mm | Right connection set, 2-wire |
| 53255300 | | transparent | plastic | 26.5 x 17 x 24.2 mm | Bottom connection set, 2-wire |



Consisting of 1 piece each, connection piece incl. cable, holder, seal and lock (with degree of protection IP65)

Horizon end cap set



| Article no.: | Price in € | Colour: | Material: | Dimensions L x W x H: | Description: |
|--------------|------------|-------------|-----------|-----------------------|---|
| 53254000 | 6.00 | transparent | plastic | 26.5 x 17 x 24.2 mm | End cap set for QUALITYFLEX Protection Horizon (with degree of protection IP65) |

QUALITYFLEX Protection cutting tool



| Article no.: | Price in € | Description: |
|--------------|------------|---|
| 81106000 | 89.90 | Special lengths can be realised independently on site using the cutting tool and the corresponding feeding and end cap set. Alternatively, we offer this service directly at our premises. On request, we can guarantee short delivery times. |

Power supply units and controls



schaltbar

Art. no. 17244000
LED power supply unit 24 V DC,
150 W, switchable
 For operation up to 5,000 mm



dimmbar

Art. no. 17528000
White light radio control
 for controlling single-colour LED
 modules in the white light range

**You can find more
 power supply units and
 control units
 from page 262 onwards.**

QUALITYFLEX Protection Horizon, TunableWhite LED flex stripe, CRI > 90, 16 W/m, IP67

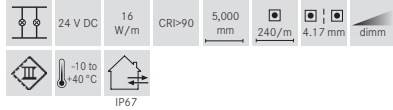
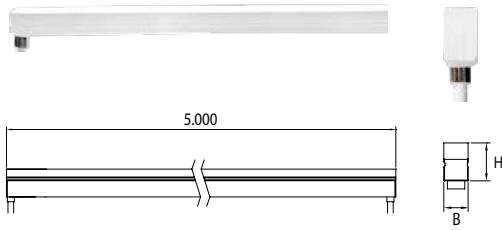

NEW

Electrical data

| | |
|-----------------------|-------------------|
| LED circuit board: | SMD-LED 3014 |
| Power consumption: | 16 W/m |
| LED number per metre: | 240 |
| Rated voltage: | 24 V DC |
| Protection class: | III |
| Ambient temperature: | -20 to +40 °C |
| Control: | Negative (3-wire) |

Photometric data

| | |
|-------------------------|----------|
| Colour rendering index: | CRI > 90 |
| Colour consistency: | SDCM < 3 |

Photometric data

| | |
|-------------|------|
| Beam angle: | 120° |
|-------------|------|

Service life:

| | |
|---------------|--|
| Service life: | L80/B10: 36,000 h L70/B50: 54,000 h |
|---------------|--|

Mechanical data

| | |
|------------------------------|-------------------|
| Length of the circuit board: | 5 m |
| max. module length: | 5,000 mm |
| Pitch: | 50 mm |
| Smallest bending radius: | 120 mm |
| Short pitch: | 4.17 mm |
| Connection cable: | 1,000 mm |
| Self-adhesive: | No |
| Feeding: | One-sided, bottom |

If the LED flex stripe is shortened and the end cap set 53254000 is used, degree of protection IP65 is achieved on site.

* Not resistant to chlorine gas, therefore must not be used in swimming pools.

Product advantages

- Suitable for indoor and outdoor (IP67) applications.
- Divisible every 50 mm (degree of protection IP65).
- UV-protected.
- Ideal for terraces, façades and entrance areas.*
- Colour temperature: 2,000 K to 6,500 K.
- Service life L80/B10: 36,000 hours.
- Simple installation with suitable aluminium profiles or fastening clips.
- Dimmable with appropriate accessories.

LED flex stripes versions



| IP67 | | | | | |
|-------------|------------|--------------|------------------|------------------|--------------------|
| Article no. | Price in € | Light colour | Luminous flux /m | EEC Spectrum A-G | Dimensions [W x H] |
| 19592004 | 1065.00 | 2,000 K | 165 lm | F | 12 x 20 mm |
| | | 6,500 K | 211 lm | | |

| IP65 | | | | | |
|-------------|------------|---------------------------------|------------------|------------------|--------------------|
| Article no. | Price in € | Light colour | Luminous flux /m | EEC Spectrum A-G | Dimensions [W x H] |
| 76592004 | 17.90 | 2,000 K | 165 lm | F | 12 x 20 mm |
| | | 6,500 K | 211 lm | | |
| 76999000 | 229.90 | Assembly Series Protection IP67 | | | |

| IP65 | | | | | |
|-------------|------------|---|------------------|------------------|--------------------|
| Article no. | Price in € | Light colour | Luminous flux /m | EEC Spectrum A-G | Dimensions [W x H] |
| 75592004 | NEW 17.90 | 2,000 K | 165 lm | F | 12 x 20 mm |
| | | 6,500 K | 211 lm | | |
| 75999000 | 23.90 | Assembly with increased degree of protection IP65 | | | |

The items on this page are subject to discount group 1.

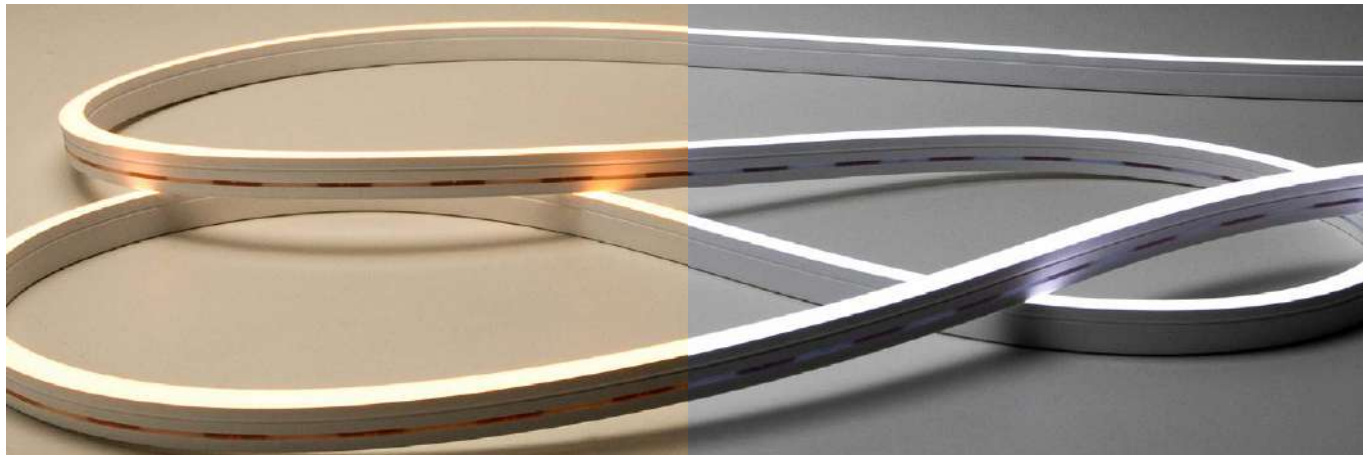

Accessories overview

Horizon mounting profile



| Article no.: | Price in € | Colour: | Material: | Dimensions L x W x H: | Description: |
|--------------|------------|--------------------|-----------|------------------------|---|
| 53581260 | 20.50 | anodised aluminium | aluminium | 1,000 x 17.5 x 22.9 mm | High mounting profile for QUALITYFLEX Protection Horizon, delivery length: 1 metre in one piece, straight lines |

Horizon special profile



| Article no.: | Price in € | Colour: | Material: | Dimensions L x W x H: | Description: |
|--------------|------------|---------|-----------------|-----------------------|---|
| 53582260 | 23.20 | silver | stainless steel | 500 x 13.5 x 18 mm | Bendable profile for QUALITYFLEX Protection Horizon, for optimum fastening at radii |

Horizon bracket set



| Article no.: | Price in € | Colour: | Material: | Dimensions L x W x H: | Description: |
|--------------|------------|---------|-----------|-----------------------|---|
| 53259000 | 13.00 | silver | steel | 20 x 12.6 x 18.9 mm | Fastening clip set for QUALITYFLEX Protection Horizon for fastening at radii, incl. 3 x clip and 3 x screw, 3 retaining clips must be fitted per 0.5 metre. |

Horizon feedings



| Article no.: | Price in € | Colour: | Material: | Dimensions L x W x H: | Description: |
|--------------|------------|-------------|-----------|-----------------------|-------------------------------|
| 53256100 | 10.00 | transparent | plastic | 26.5 x 17 x 24.2 mm | Front connection set, 3-wire |
| 53256200 | | transparent | plastic | 26.5 x 17 x 24.2 mm | Right connection set, 3-wire |
| 53256300 | | transparent | plastic | 26.5 x 17 x 24.2 mm | Bottom connection set, 3-wire |

Consisting of 1 piece each, connection piece incl. cable, holder, seal and lock (with degree of protection IP65)

Horizon end cap set



| Article no.: | Price in € | Colour: | Material: | Dimensions L x W x H: | Description: |
|--------------|------------|-------------|-----------|-----------------------|---|
| 53254000 | 6.00 | transparent | plastic | 26.5 x 17 x 24.2 mm | End cap set for QUALITYFLEX Protection Horizon (with degree of protection IP65) |

QUALITYFLEX Protection cutting tool



| Article no.: | Price in € | Description: |
|--------------|------------|---|
| 81106000 | 89.90 | Special lengths can be realised independently on site using the cutting tool and the corresponding feeding and end cap set. Alternatively, we offer this service directly at our premises. On request, we can guarantee short delivery times. |

Power supply units and controls



schaltbar

Art. no. 17243000
LED power supply unit 24 V DC,
120 W, switchable
 For operation up to 5,000 mm



dimmbar

Art. no. 18155000
LED dimmer 12-24 V DC,
DALI (DT8), dimmable
 For operation up to 5,000 mm



dimmbar

Art. no. 17518000
TunableWhite radio control
 for two-colour LED modules in the
 white light range



**You can find more
 power supply units and
 control units
 from page 262 onwards.**

QUALITYFLEX Protection Horizon, RGBW LED flex stripe, CRI > 80, 15 W/m, IP67

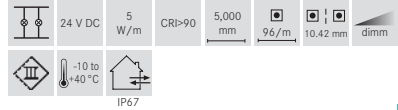
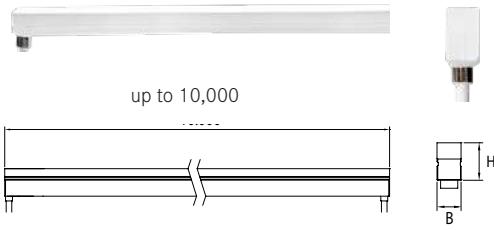

NEW

Electrical data

| | |
|-----------------------|-------------------|
| LED circuit board: | SMD-LED 5050 |
| Power consumption: | 15 W/m |
| LED number per metre: | 96 |
| Rated voltage: | 24 VDC |
| Protection class: | III |
| Ambient temperature: | -20 to +40 °C |
| Control: | Negative (5-wire) |

Photometric data

| | |
|-------------------------|---------------------|
| Colour rendering index: | CRI > 80 at 2,700 K |
|-------------------------|---------------------|

Photometric data

| | |
|-------------|------|
| Beam angle: | 120° |
|-------------|------|

Service life:

| | |
|---------------|--|
| Service life: | L80/B10: 36,000 h L70/B50: 54,000 h |
|---------------|--|

Mechanical data

| | |
|------------------------------|-------------------|
| Length of the circuit board: | 5 m, 10 m |
| max. module length: | 10,000 mm |
| Pitch: | 125 mm |
| Smallest bending radius: | 120 mm |
| Short pitch: | 10.42 mm |
| Connection cable: | 1,000 mm |
| Self-adhesive: | No |
| Feeding: | One-sided, bottom |

If the LED flex stripe is shortened and the end cap set 53254000 is used, degree of protection IP65 is achieved on site.

* Not resistant to chlorine gas, therefore must not be used in swimming pools.

Product advantages

- Suitable for indoor and outdoor (IP67) applications.
- Divisible every 125 mm (degree of protection IP65).
- UV-protected.
- Ideal for terraces, façades and entrance areas.*
- Light colours: red / green / blue / white (colour temperature: 2,700 K, CRI > 80)
- Service life L80/B10: 36,000 hours.
- Simple installation with suitable aluminium profiles or fastening clips.
- Dimmable with appropriate accessories.

LED flex stripes versions



| IP67 | | | | | | |
|-------------|------------|---------------------------------|------------------|------------------|--------------------|--|
| Article no. | Price in € | Light colour | Luminous flux /m | EEC Spectrum A-G | Dimensions [W x H] | |
| 19602502 | 760.00 | 2,700 K | approx. 122 lm | F | 12 x 20 mm | |
| | | red | approx. 36 lm | | | |
| | | green | approx. 107 lm | | | |
| | | blue | approx. 34 lm | | | |
| Article no. | Price in € | Light colour | Luminous flux /m | EEC Spectrum A-G | Dimensions [W x H] | |
| 19602002 | 1495.00 | 2,700 K | approx. 122 lm | F | 12 x 20 mm | |
| | | red | approx. 36 lm | | | |
| | | green | approx. 107 lm | | | |
| | | blue | approx. 34 lm | | | |
| Article no. | Price in € | Light colour | Luminous flux /m | EEC Spectrum A-G | Dimensions [W x H] | |
| 76602002 | 31.40 | 2,700 K | approx. 122 lm | F | 12 x 20 mm | |
| | | red | approx. 36 lm | | | |
| | | green | approx. 107 lm | | | |
| | | blue | approx. 34 lm | | | |
| 76999000 | 229.90 | Assembly Series Protection IP67 | | | | |

| IP65 | | | | | | |
|-------------|------------|---|------------------|------------------|--------------------|--|
| Article no. | Price in € | Light colour | Luminous flux /m | EEC Spectrum A-G | Dimensions [W x H] | |
| 75602002 | 31.40 | 2,700 K | approx. 122 lm | F | 12 x 20 mm | |
| | | red | approx. 36 lm | | | |
| | | green | approx. 107 lm | | | |
| | | blue | approx. 34 lm | | | |
| 75999000 | 23.90 | Assembly with increased degree of protection IP65 | | | | |

The items on this page are subject to discount group 1.

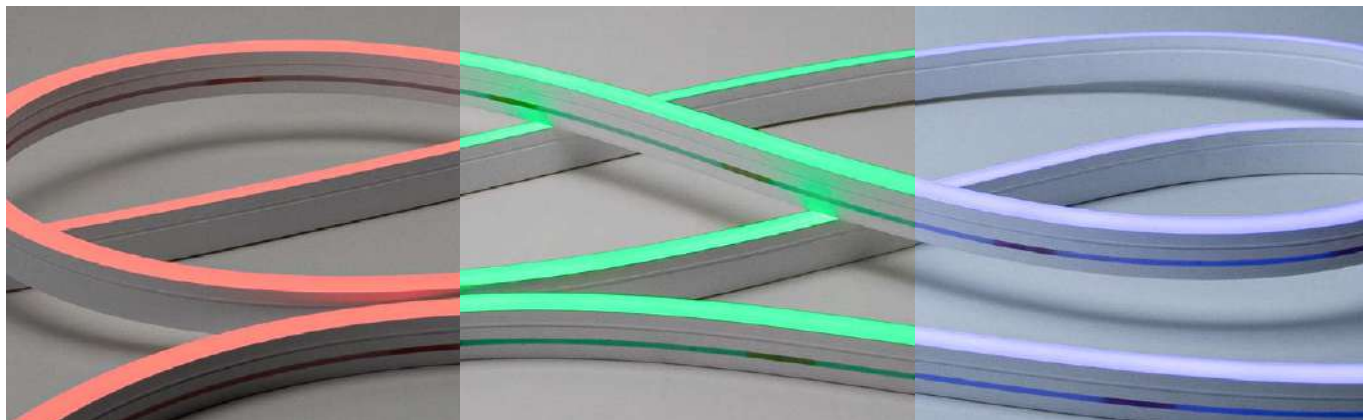

Accessories overview

Horizon mounting profile



| Article no.: | Price in € | Colour: | Material: | Dimensions L x W x H: | Description: |
|--------------|------------|--------------------|-----------|------------------------|---|
| 53581260 | 20.50 | anodised aluminium | aluminium | 1,000 x 17.5 x 22.9 mm | High mounting profile for QUALITYFLEX Protection Horizon, delivery length: 1 metre in one piece, straight lines |

Horizon special profile



| Article no.: | Price in € | Colour: | Material: | Dimensions L x W x H: | Description: |
|--------------|------------|---------|-----------------|-----------------------|---|
| 53582260 | 23.20 | silver | stainless steel | 500 x 13.5 x 18 mm | Bendable profile for QUALITYFLEX Protection Horizon, for optimum fastening at radii |

Horizon bracket set



| Article no.: | Price in € | Colour: | Material: | Dimensions L x W x H: | Description: |
|--------------|------------|---------|-----------|-----------------------|---|
| 53259000 | 13.00 | silver | steel | 20 x 12.6 x 18.9 mm | Fastening clip set for QUALITYFLEX Protection Horizon for fastening at radii, incl. 3 x clip and 3 x screw, 3 retaining clips must be fitted per 0.5 metre. |

Horizon feedings



| Article no.: | Price in € | Colour: | Material: | Dimensions L x W x H: | Description: |
|--------------|------------|-------------|-----------|-----------------------|-------------------------------|
| 53257100 | 12.00 | transparent | plastic | 26.5 x 17 x 24.2 mm | Front connection set, 5-wire |
| 53257200 | | transparent | plastic | 26.5 x 17 x 24.2 mm | Right connection set, 5-wire |
| 53257300 | | transparent | plastic | 26.5 x 17 x 24.2 mm | Bottom connection set, 5-wire |

Consisting of 1 piece each, connection piece incl. cable, holder, seal and lock (with degree of protection IP65)

Horizon end cap set



| Article no.: | Price in € | Colour: | Material: | Dimensions L x W x H: | Description: |
|--------------|------------|-------------|-----------|-----------------------|---|
| 53254000 | 6.00 | transparent | plastic | 26.5 x 17 x 24.2 mm | End cap set for QUALITYFLEX Protection Horizon (with degree of protection IP65) |

QUALITYFLEX Protection cutting tool



| Article no.: | Price in € | Description: |
|--------------|------------|---|
| 81106000 | 89.90 | Special lengths can be realised independently on site using the cutting tool and the corresponding feeding and end cap set. Alternatively, we offer this service directly at our premises. On request, we can guarantee short delivery times. |

Power supply units and controls



schaltbar

Art. no. 17243000
LED power supply unit 24 V DC,
120 W, switchable
For operation up to 5,000 mm



dimmbar

Art. no. 18223000
RGBW radio control
for controlling RGBW LED
modules for colour and white light.

You can find more
power supply units and
control units
from page 262 onwards.



Private house, Augsburg



Private house, Vreden



Private house, Emsdetten



Private house, Kleinwallstadt



Künstlerdorf, Schöppingen

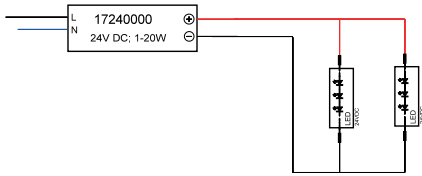

LED power supply unit 24 V DC, switchable

This power supply unit is protected against overvoltage and short circuit as well as thermal and electrical overload by fuses. The input and output terminals are suitable for cables with a cross-section of up to 1.5 mm².

Dimensions: L 150 x W 40 x H 30 mm,
 input voltage: AC: 120-240 V,
 frequency: 50 Hz, type of dimming: switchable,
 ambient temperature (ta): -20 to +45 °C,
 measuring point (tc): max. +85 °C,
 material: plastic

| Article no. | Secondary voltage | Power | Price in € |
|-------------|-------------------|--------|------------|
| 17240000 | 24 V | 1-20 W | 29.90 |



This item is subject to discount group 1.

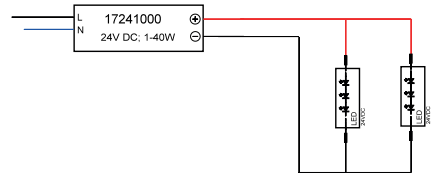

LED power supply unit 24 V DC, switchable

This power supply unit is protected against overvoltage and short circuit as well as thermal and electrical overload by fuses. The input and output terminals are suitable for cables with a cross-section of up to 1.5 mm².

Dimensions: L 210 x W 40 x H 30 mm,
 input voltage: AC: 120-240 V,
 frequency: 50 Hz, type of dimming: switchable,
 ambient temperature (ta): -20 to +45 °C,
 measuring point (tc): max. +85 °C,
 material: plastic

| Article no. | Secondary voltage | Power | Price in € |
|-------------|-------------------|--------|------------|
| 17241000 | 24 V | 1-40 W | 39.90 |



This item is subject to discount group 1.

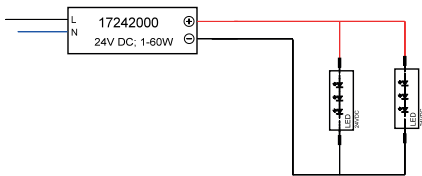

LED power supply unit 24 V DC, switchable

This power supply unit is protected against overvoltage and short circuit as well as thermal and electrical overload by fuses. The input and output terminals are suitable for cables with a cross-section of up to 1.5 mm².

Dimensions: L 250 x W 40 x H 30 mm,
 input voltage: AC: 120-240 V,
 frequency: 50 Hz, type of dimming: switchable,
 ambient temperature (ta): -20 to +45 °C,
 measuring point (tc): max. +85 °C,
 material: plastic

| Article no. | Secondary voltage | Power | Price in € |
|-------------|-------------------|--------|------------|
| 17242000 | 24 V | 1-60 W | 49.90 |



This item is subject to discount group 1.

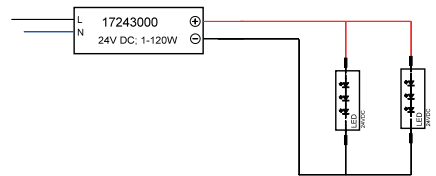

LED power supply unit 24 V DC, switchable

This power supply unit is protected against overvoltage and short circuit as well as thermal and electrical overload by fuses. The input and output terminals are suitable for cables with a cross-section of up to 1.5 mm².

Dimensions: L 300 x W 40 x H 30 mm,
 input voltage: AC: 120-240 V,
 frequency: 50 Hz, type of dimming: switchable,
 ambient temperature (ta): -20 to +45 °C,
 measuring point (tc): max. +85 °C,
 material: plastic

| Article no. | Secondary voltage | Power | Price in € |
|-------------|-------------------|---------|------------|
| 17243000 | 24 V | 1-120 W | 79.90 |



This item is subject to discount group 1.

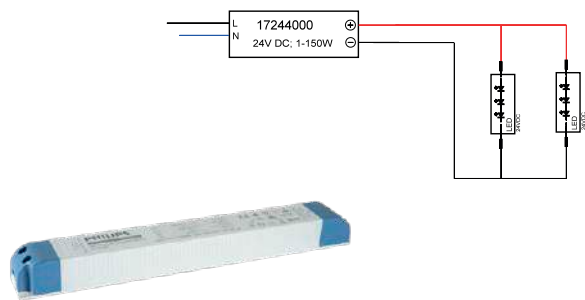

LED power supply unit 24 V DC, switchable

This power supply unit is protected against overvoltage and short circuit as well as thermal and electrical overload by fuses. The input and output terminals are suitable for cables with a cross-section of up to 1.5 mm².

Dimensions: L 310 x W 40 x H 30 mm,
 input voltage: AC: 120-240 V,
 frequency: 50 Hz, type of dimming: switchable,
 ambient temperature (ta): -20 to +45 °C,
 measuring point (tc): max. +85 °C,
 material: plastic

| Article no. | Secondary voltage | Power | Price in € |
|-------------|-------------------|---------|------------|
| 17244000 | 24 V | 1-150 W | 89.90 |



This item is subject to discount group 1.

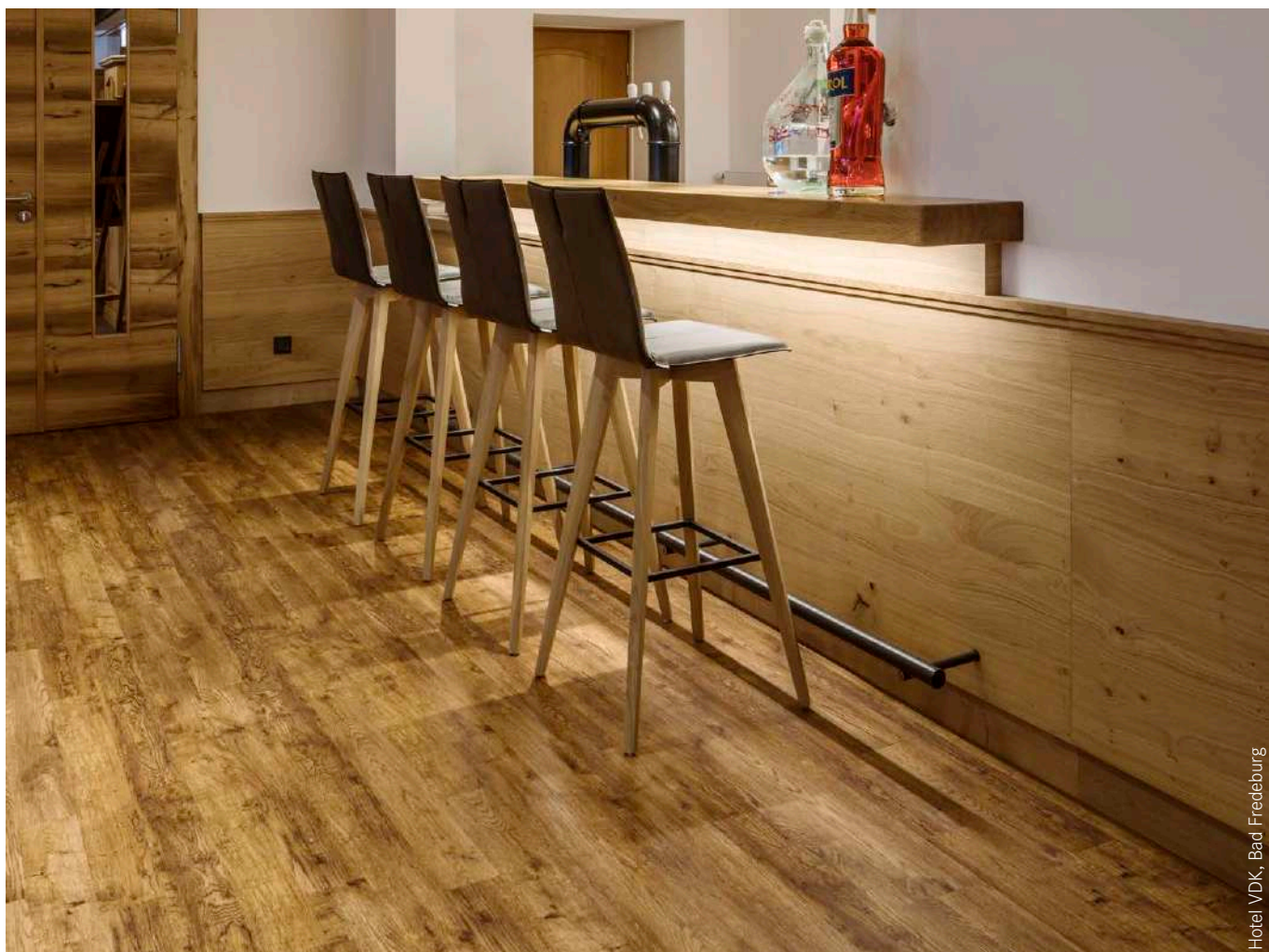

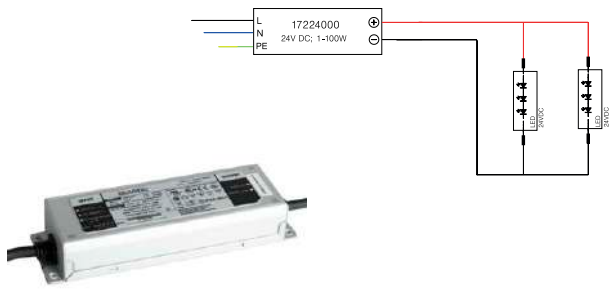

LED power supply unit 24 V DC, switchable

This power supply unit is protected against overvoltage and short circuit as well as thermal and electrical overload by fuses.

Dimensions: L 199 x W 63 x H 36 mm,
 input voltage: AC: 180-295 V,
 frequency: 50 Hz, type of dimming: switchable,
 ambient temperature (ta): -40 °C to +80 °C,
 measuring point (tc): max. +90 °C,
 material: aluminium

| Article no. | Secondary voltage | Power | Price in € |
|-------------|-------------------|---------|------------|
| 17224000 | 24 V | 1-100 W | 149.90 |



This item is subject to discount group 1.

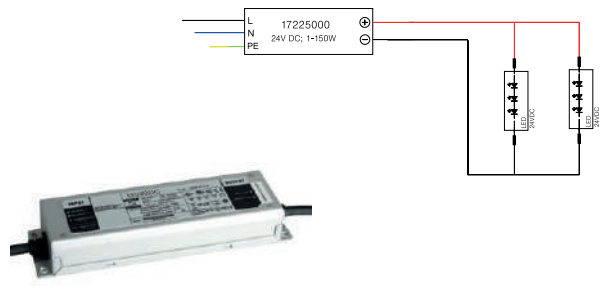

LED power supply unit 24 V DC, switchable

This power supply unit is protected against overvoltage and short circuit as well as thermal and electrical overload by fuses.

Dimensions: L 219 x W 63 x H 36 mm,
 input voltage: AC: 100-305 V, DC: 142-431 V,
 frequency: 50 Hz, type of dimming: switchable,
 ambient temperature (ta): -40 °C to +80 °C,
 measuring point (tc): max. +90 °C,
 material: aluminium

| Article no. | Secondary voltage | Power | Price in € |
|-------------|-------------------|---------|------------|
| 17225000 | 24 V | 1-150 W | 159.90 |



This item is subject to discount group 1.

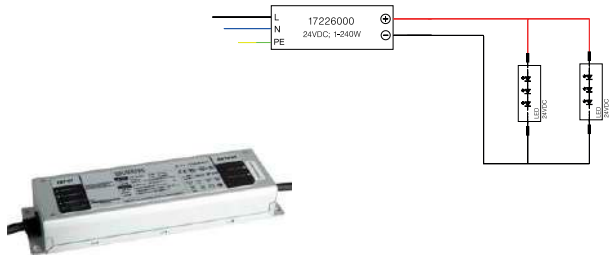

LED power supply unit 24 V DC, switchable

This power supply unit is protected against overvoltage and short circuit as well as thermal and electrical overload by fuses.

Dimensions: L 244 x W 71 x H 38 mm,
 input voltage: AC: 100-305 V, DC: 142-432 V,
 frequency: 50 Hz, type of dimming: switchable,
 ambient temperature (ta): -40 °C to +80 °C,
 measuring point (tc): max. +90 °C,
 material: aluminium

| Article no. | Secondary voltage | Power | Price in € |
|-------------|-------------------|---------|------------|
| 17226000 | 24 V | 1-240 W | 209.90 |



This item is subject to discount group 1.



LED power supply unit 24 V DC, switchable NEW

This power supply unit is protected against overvoltage and short circuit as well as thermal and electrical overload by fuses.

Dimensions: L 252 x W 90 x H 44 mm,
 input voltage: AC: 90-305 V, DC: 127-431 V,
 frequency: 47 Hz - 63 Hz, type of dimming: switchable,
 ambient temperature (ta): -40 °C to +70 °C,
 measuring point (tc): max. +90 °C,
 material: aluminium

| Article no. | Secondary voltage | Power | Price in € |
|--|-------------------|---------|------------|
| 17227000 NEW | 24 V | 1-320 W | 299.90 |



This item is subject to discount group 1.



LED power supply unit 24 V DC, switchable NEW

This power supply unit is protected against overvoltage and short circuit as well as thermal and electrical overload by fuses.

Dimensions: L 262 x W 125 x H 44 mm,
 input voltage: AC: 90-305 V, DC: 127-431 V,
 frequency: 47 Hz - 63 Hz, type of dimming: switchable,
 ambient temperature (ta): -40 °C to +70 °C,
 measuring point (tc): max. +90 °C,
 material: aluminium

| Article no. | Secondary voltage | Power | Price in € |
|--|-------------------|---------|------------|
| 17228000 NEW | 24 V | 1-480 W | 399.90 |



This item is subject to discount group 1.

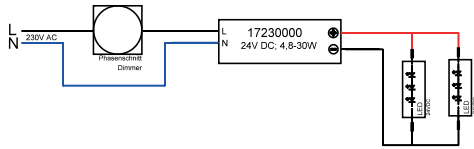

LED power supply unit 24 V DC, trailing-edge phase dimmable

This power supply unit is protected against overvoltage and short circuit as well as thermal and electrical overload by fuses.

Dimensions: L 145 x W 50 x H 22 mm,
input voltage: AC: 220-240 V,
frequency: 50 Hz, type of dimming: trailing-edge phase,
ambient temperature (ta): -20 to +50 °C,
measuring point (tc): max. +80 °C,
material: plastic

| Article no. | Secondary voltage | Power | Price in € |
|-------------|-------------------|-------|------------|
| 17230000 | 24 V | 30 W | 64.90 |



This item is subject to discount group 1.

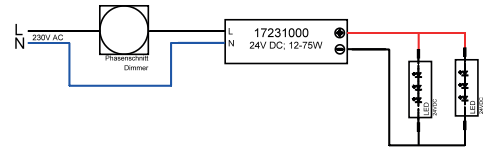

LED power supply unit 24 V DC, trailing-edge phase dimmable

This power supply unit is protected against overvoltage and short circuit as well as thermal and electrical overload by fuses.

Dimensions: L 185 x W 60 x H 31 mm,
input voltage: AC: 220-240 V,
frequency: 50 Hz, type of dimming: trailing-edge phase,
ambient temperature (ta): -10 °C to +45 °C,
measuring point (tc): max. +80 °C,
material: plastic

| Article no. | Secondary voltage | Power | Price in € |
|-------------|-------------------|-------|------------|
| 17231000 | 24 V | 75 W | 119.90 |



This item is subject to discount group 1.

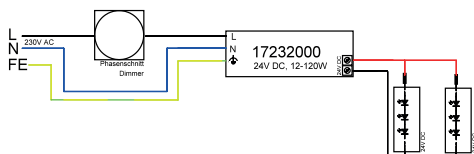

LED power supply unit 24 V DC, trailing-edge phase dimmable

This power supply unit is protected against overvoltage and short circuit as well as thermal and electrical overload by fuses.

Dimensions: L 223 x W 64 x H 32 mm,
input voltage: AC: 220-240 V,
frequency: 50 Hz, type of dimming: trailing-edge phase,
ambient temperature (ta): -20 to +45 °C,
measuring point (tc): max. +85 °C,
material: plastic

| Article no. | Secondary voltage | Power | Price in € |
|-------------|-------------------|-------|------------|
| 17232000 | 24 V | 120 W | 139.90 |



This item is subject to discount group 1.

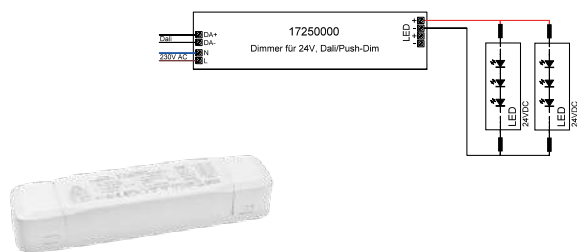

LED power supply unit 24 V DC, DALI-2 dimmable

NEW

This power supply unit is protected against overvoltage and short circuit as well as thermal and electrical overload by fuses. The input and output terminals are suitable for cables with a cross-section of up to 1.5 mm².

Dimensions: L 187 x W 45 x H 31 mm,
input voltage: AC: 220-240 V,
frequency: 50 Hz, control: dimmable DALI-2/PUSH,
ambient temperature (ta): -20 to +50 °C,
measuring point (tc): max. +85 °C,
material: plastic

| Article no. | Secondary voltage | Power | Price in € |
|---------------------|-------------------|--------|------------|
| 17250000 NEW | 24 V | 1-45 W | 159.90 |



This item is subject to discount group 1.

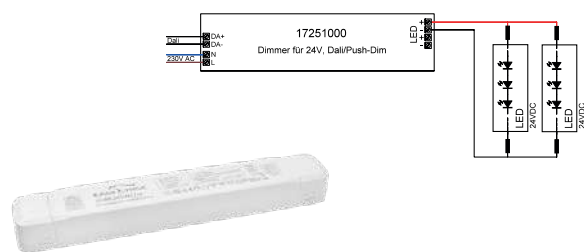

LED power supply unit 24 V DC, DALI-2 dimmable

NEW

This power supply unit is protected against overvoltage and short circuit as well as thermal and electrical overload by fuses. The input and output terminals are suitable for cables with a cross-section of up to 1.5 mm².

Dimensions: L 290 x W 45 x H 31 mm,
input voltage: AC: 220-240 V,
frequency: 50 Hz, control: dimmable DALI-2/PUSH,
ambient temperature (ta): -20 to +50 °C,
measuring point (tc): max. +85 °C,
material: plastic

| Article no. | Secondary voltage | Power | Price in € |
|---------------------|-------------------|--------|------------|
| 17251000 NEW | 24 V | 1-80 W | 209.90 |



This item is subject to discount group 1.

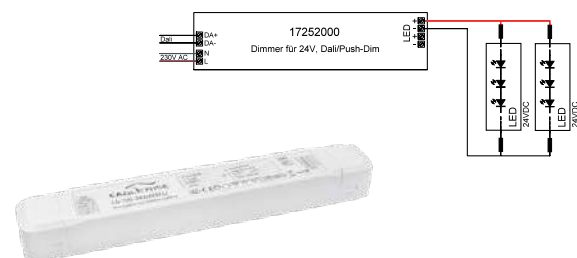

LED power supply unit 24 V DC, DALI-2 dimmable

NEW

This power supply unit is protected against overvoltage and short circuit as well as thermal and electrical overload by fuses. The input and output terminals are suitable for cables with a cross-section of up to 1.5 mm².

Dimensions: L 290 x W 45 x H 31 mm,
input voltage: AC: 220-240 V,
frequency: 50 Hz, control: dimmable DALI-2/PUSH,
ambient temperature (ta): -20 to +50 °C,
measuring point (tc): max. +85 °C,
material: plastic

| Article no. | Secondary voltage | Power | Price in € |
|---------------------|-------------------|---------|------------|
| 17252000 NEW | 24 V | 1-150 W | 269.90 |



This item is subject to discount group 1.



LED dimmer 12-24 V DC, dimmable

LED dimmer series for constant voltage operation (12-24 V DC) via 4 channels (single or multi-coloured). The wiring is screwless via plug-in terminals. Cable cross-section: 0.5 – 2.5 mm².

An external power supply is required for operation, output signal (dimming): PWM (pulse width modulation), with reverse polarity and over-temperature protection.

Max. output current: 10 A (4 x 2.5 A; 3 x 3.33 A; 2 x 5 A; 1 x 5 A)
 Max. output power 12 V: 120 W (4 x 30 W; 3 x 40 W; 2 x 60 W; 1 x 60 W)
 Max. output power 24 V: 240 W (4 x 60 W; 3 x 80 W; 2 x 120 W; 1 x 120 W)

18151000: 4-channel device with max. 4 addresses (KNX). An address is assigned to each channel (output) and the KNX dimmer can be used for monochrome, RGB and RGBW luminaires. KNX certified device, configurable via ETS software (4.0F or higher). System application or KNX-PROD file in German for download at www.brumberg.com. Functions / objects: switching, relative dimming, absolute dimming, preset, scenes, colour sequences, two pre-programmed colour gradients, etc.

18152000: 1-4 channel device with 1-4 addresses (DALI DT6). The channels (outputs) can be combined to 1, 2, 3 or 4 addresses. As an alternative to DALI, the 4 channels (outputs) can be controlled (dimmed) simultaneously, i.e. all four channels behave in the same way, via a push-button (push-dimm, switch-dimm).

18153000: 1-4 channel device with 1-4 addresses (DMX). The channels (outputs) can be combined to 1, 2, 3 or 4 addresses.

18154000: 1-4 channel device with max. 4 x 1-10 V inputs. The inputs can be combined with each other.

18155000: DALI DT8 4-channel device, for controlling TunableWhite and RGBW luminaires. Depending on the operating mode set, only one DALI address is required thanks to the DALI DT8 protocol.

The following settings are possible:

TunableWhite:

2 channels, each with 2 outputs for warm white (channel A- & C-) and cool white (channel B- & D-). Depending on the setting, synchronised operation of both outputs is possible, or independent of each other.

RGBW:

4 channels, one channel each for red, green and blue. The connected lights can be switched, changed in colour temperature (TunableWhite) or colour spectrum (RGBW), and dimmed.

Dimensions: L 170 x W 54 x H 30 mm, ambient temperature (ta): 0 °C to +45 °C, measuring point (tc): max. +70 °C, material: plastic

| Article no. | Description | Price in € |
|-------------|--|------------|
| 18151000 | KNX system requirements: min. ETS 4.0 or higher. | 499.90 |
| 18152000 | DALI (DT6) | 149.90 |
| 18153000 | DMX | 129.90 |
| 18154000 | 1-10 V | 129.90 |
| 18155000 | DALI (DT8) TunableWhite or RGBW | 154.90 |



This item is subject to discount group 1.



REG LED dimmer 12-24 V DC, dimmable

LED dimmer series for constant voltage operation (12-24 V DC) via 4 channels (single or multi-coloured). The wiring is screwless via plug-in terminals. Cable cross-section: 0.5 – 2.5 mm².

An external power supply is required for operation, output signal (dimming): PWM (pulse width modulation), with reverse polarity and over-temperature protection.

Max. output current: 10 A (4 x 2.5 A; 3 x 3.33 A; 2 x 5 A; 1 x 5 A)
 Max. output power 12 V: 120 W (4 x 30 W; 3 x 40 W; 2 x 60 W; 1 x 60 W)
 Max. output power 24 V: 240 W (4 x 60 W; 3 x 80 W; 2 x 120 W; 1 x 120 W)

18161000: 4-channel device with max. 4 addresses (KNX). An address is assigned to each channel (output). The KNX dimmer can be used for monochrome, RGB and RGBW luminaires. KNX certified device, configurable via ETS software (4.0F or higher). System application or KNX-PROD file in German for download at www.brumberg.com. Functions / objects: switching, relative dimming, absolute dimming, preset, scenes, colour sequences, two pre-programmed colour gradients, etc.

18162000: 1-4 channel device with 1-4 addresses (DALI DT6). The channels (outputs) can be combined to 1, 2, 3 or 4 addresses. As an alternative to DALI, the 4 channels (outputs) can be controlled (dimmed) simultaneously, i.e. all four channels behave in the same way, via a push-button (push-dimm, switch-dimm).

18164000: 1-4 channel device with max. 4 x 1-10 V inputs. The inputs can be combined with each other.

18165000: DALI DT8 4-channel device, for controlling TunableWhite and RGBW luminaires. Depending on the operating mode set, only one DALI address is required thanks to the DALI DT8 protocol.

The following settings are possible:

TunableWhite:

2 channels, each with 2 outputs for warm white (channel A- & C-) and cool white (channel B- & D-). Depending on the setting, synchronised operation of both outputs is possible, or independent of each other.

RGBW:

4 channels, one channel each for red, green and blue. The connected lights can be switched, changed in colour temperature (TunableWhite) or colour spectrum (RGBW), and dimmed.

Dimensions: L 54 x W 110 x H 66 mm, 3 TE, ambient temperature (ta): 0 °C to +45 °C, measuring point (tc): max. +75 °C, material: plastic

| Article no. | Description | Price in € |
|-------------|--|------------|
| 18161000 | KNX system requirements: min. ETS 4.0 or higher. Width: 4 TE | 499.90 |
| 18162000 | DALI (DT6) Width: 3 TE | 149.90 |
| 18164000 | 1-10 V Width: 3 TE | 127.90 |
| 18165000 | DALI (DT8) TunableWhite or RGBW Width: 3 TE | 154.90 |

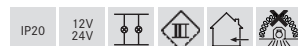

This item is subject to discount group 1.



DALI-DT6 RGBW wall panel

DALI RGBW wall panel for controlling RGBW LED modules

Nominal voltage: 110-230 V AC 50 Hz,

Power consumption: 15 mA,

Ambient temperature (ta): 0 °C to +40 °C,

Connection via screw terminals,

Installation in device box (flush-mounted),

Installation depth in device box: 32 mm,

External dimensions: L 86 mm x W 86 mm x D 41 mm,

Projection: 9 mm

Material: glass / plastic,

Output: DALI-D6 signal

Incl. DALI bus voltage 100 mA

DALI consumption: 4mA

max., up to 12 DALI dimmers art. no. 18152000 or 18162000 can be controlled.

Stand-alone version, cannot be integrated into a DALI environment.

Range of functions:

- On / Off
 - RGB colour change via touch wheel
 - Dimming buttons for red / green / blue / white
 - Dimming of the set light colour
 - Save button S
 - Colour gradient: Start / Stop
 - Colour gradient: speed
- Compatible with our 4-channel DALI-DT6 dimmers with item no. 18152000 or 18162000.

| Article no. | Colour | Price in € |
|-------------|--------|------------|
| 18252070 | white | 249.90 |
| 18252080 | black | 249.90 |



This item is subject to discount group 1.

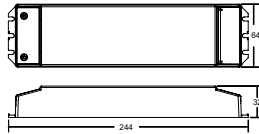

LED power supply unit 24 V DC, incl. 4-channel DALI-2 / DALI-DT8 dimmable

LED power supply unit incl. DALI 4-channel LED dimmer, 24 V DC, sec. output max. 100 watts. for controlling TunableWhite and RGBW LED luminaires or LED flex stripes.

Dimensions: L 244 x W 64 x H 32 mm, input voltage: AC: 100-240 V, control: DALI-2 / DALI-DT8, material: plastic

Ambient temperature (ta): -20 to +45 °C,
Measuring point (tc): max. +75 °C

| Article no. | Secondary voltage | Power | Price in € |
|-------------|-------------------|---------|------------|
| 17290000 | 24 V DC | 1-100 W | 239.90 |



This item is subject to discount group 1.

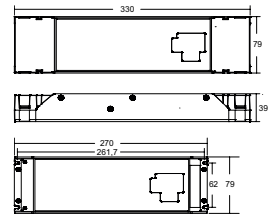

LED power supply unit 24 V DC, incl. 4-channel DALI-2 / DALI-DT8 dimmable

LED power supply unit incl. DALI 4-channel LED dimmer, 24 V DC, sec. output max. 200 watts. for controlling TunableWhite and RGBW LED luminaires or LED flex stripes.

Dimensions: L 330 x W 79 x H 39 mm, input voltage: AC: 100-240 V, control: DALI-2 / DALI-DT8, material: aluminium / plastic

Ambient temperature (ta): -20 to +45 °C,
Measuring point (tc): max. +85 °C

| Article no. | Secondary voltage | Power | Price in € |
|-------------|-------------------|---------|------------|
| 17291000 | 24 V DC | 1-200 W | 389.90 |



This item is subject to discount group 1.





LED dimmer 24 V DC, DALI-, 1-10 V-, PUSH-dimmable

LED dimmer single-channel (single-colour) for constant voltage operation (24 V DC). The wiring is done via plug-in terminals. Cable cross-section: 0.5 – 2.5 mm². An external power supply is required for operation. Output signal (dimming): PWM (pulse width modulation). With overload, short-circuit, overtemperature and open-circuit protection, max. output current: 5 A.

The device can be controlled via DALI or a push-button (push-dimming) or 1-10 V. Several devices can be operated as master/slave to extend the performance.

Dimensions: L 153 x W 30 x H 21 mm without strain relief.
L 184 x W 35 x H 24 mm with strain relief, input voltage: 24 V DC, type of dimming: DALI, 1-10 V, DALI/PUSH, ambient temperature (ta): -20 °C to +40 °C, measuring point (tc): max. +55 °C, material: plastic



TunableWhite LED dimmer 12-24 V DC, 2 x 1-10 V

LED dimmer, two-channel (single or dual-colour) for constant voltage operation (12-24 V DC). The wiring is done via screw terminals. Cable cross-section: 0.5 – 2.5 mm². An external power supply is required for operation.

Output signal (dimming): PWM (pulse width modulation).
With overload and short-circuit protection, max. output power: 2 x 192 W.

Using two 1-10 V signals, the device can either dim two independent groups of luminaires or change and dim the colour temperature of a TunableWhite group.

Dimensions: L 167 x W 51 x H 23 mm, input voltage: 12-24 V DC, type of dimming: 1-10 V, ambient temperature (ta): -20 to +50 °C, Measuring point (tc): max. +75 °C, material: plastic

| Article no. | Secondary voltage | Power | Price in € |
|-------------|-------------------|---------|------------|
| 17502000 | 24 V | 0-120 W | 119.90 |



This item is subject to discount group 1.

| Article no. | Price in € |
|-------------|------------|
| 18156000 | 269.90 |



This item is subject to discount group 1.

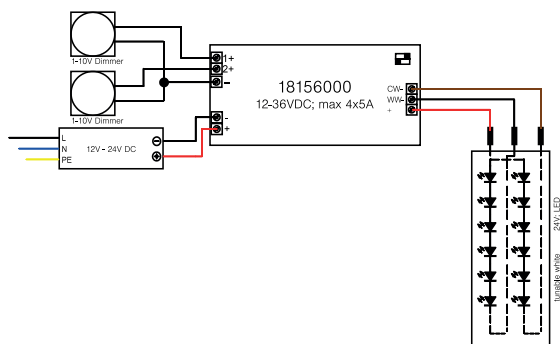
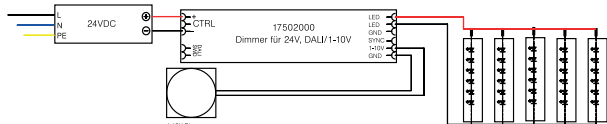



LED dimmer 12-24 V DC, Zigbee dimmable

Zigbee LED dimmer for constant voltage operation (12-24 V DC) via 5 channels. The device can be set for different operating modes.

- 5 x "single-coloured" (not independent),
- 2 x "TunableWhite" (not independent),
- 1 x RGBW,
- 1 x RGB + TunableWhite

An external power supply is required for operation. The input and output terminals are suitable for cables with a cross-section of up to 1.5 mm².

- Input voltage: 12 – 24 V DC,
- Output voltage: depending on the input voltage (12-24 V DC),
- Output current: 4 A per channel,
- Output power: 48 W (12 V DC) – 96 W (24 V DC) per channel,
- Ambient temperature (ta): -20 to +50 °C,
- Measuring point (tc): max. +75 °C,
- Incl. strain relief,
- Material: plastic,
- Dimensions: L 145 x W 46.5 x H 16 mm,
- Frequency: 2.4 GHz, protocol: ZigBee 3.0

ZigBee RGB radio remote control for 18157000

Zigbee LED radio control for the ZigBee LED dimmer 18157000 enables the coupling of ZigBee lighting devices via touchlink commissioning. Supports search and bind mode for coupling with ZigBee lighting devices. Enables the connection and control of universal DIM, CCT, RGB, RGBW and RGB + CCT ZigBee lighting devices

Transmission range (line of sight): up to 30 m.

Up to four groups (max. 30 receivers) can be controlled independently with one remote control. Seven individual colours and brightness levels can be saved and called up. Six preset scenes and five colour temperatures can be called up. Adjustment of RGB colour saturation possible.

Voltage (battery): 6 V DC – 2 x CR2032 (not included)

Frequency: 2.4 GHz, transmission power (Ps) < 0 dBm, protocol: ZigBee 3.0

Dimensions: L 137 x W 45 x H 13 mm, material: plastic

| Article no. | Description | Price in € |
|-------------|-------------|------------|
| 18157000 | ZigBee 3.0 | 127.90 |



This item is subject to discount group 1.

| Article no. | Price in € |
|-------------|------------|
| 18207000 | 127.90 |



This item is subject to discount group 1.

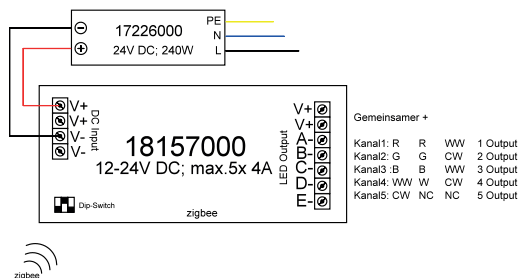



White light radio control

White light radio control for controlling single-colour LED modules in the white light range or for controlling the dim2warm flex stripes 15313003 / 15363003 etc.

Controller:

Voltage: 12-24 V DC,
 Power: max. 10 A (2 x 5 A or 3 x 3.33 A),
 Power: max. 120 W / 240 W (12 V DC / 24 V DC),
 Control: negative (common anode),
 Control signal: PWM,
 Radio frequency: 869.5 MHz,
 Range (line of sight): up to 20 m,
 Ambient temperature (ta): 0 °C to +40 °C,
 Controller connection via screw terminals,
 Dimensions: L 145 x W 46.5 x H 16 mm,
 Material: plastic, includes strain relief,
 Controller per remote control: max. 4 (with optimum radio connection)

Remote control:

Voltage (battery): 4.5 V DC – 3 x AAA (not included),
 Radio frequency: 869.5 MHz, transmission power (Ps) < 0 dBm,
 Range (line of sight): up to 20 m,
 Ambient temperature (ta): 0 °C to +40 °C,
 Dimensions: L 120 x W 48 x H 18 mm,
 Material: plastic

Range of functions:

- On / Off
- Dimming via touchwheel
- Save buttons S1 / S2
- Selection buttons 25% / 50% / 75% / 100% brightness

| Article no. | Description | Price in € |
|-------------|---|------------|
| 17528000 | White light set (controller incl. remote control) | 129.90 |
| 17511000 | White light controller | 64.90 |



This item is subject to discount group 1.

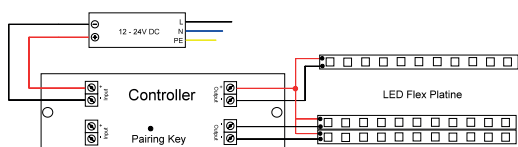

TunableWhite radio control

TunableWhite radio control for controlling two-colour LED modules in the white light range.

Controller:

Voltage: 12-24 V DC,
 Power: max. 2 x 5 A,
 Power: max. 120 W / 240 W (12 V DC / 24 V DC),
 Control: negative (common anode),
 Control signal: PWM,
 Radio frequency: 869.5 MHz,
 Range (line of sight): up to 20 m,
 Ambient temperature (ta): 0 °C to +40 °C,
 Controller connection via screw terminals,
 Dimensions: L 145 x W 46.5 x H 16 mm,
 Material: plastic, includes strain relief,
 Controller per remote control: max. 4 (with optimum radio connection)

Remote control:

Voltage (battery): 4.5 V DC – 3 x AAA (not included),
 Radio frequency: 869.5 MHz, transmission power (Ps) < 0 dBm,
 Range (line of sight): up to 20 m,
 Ambient temperature (ta): 0 °C to +40 °C,
 Dimensions: L 120 x W 48 x H 18 mm,
 Material: plastic

Range of functions:

- On / Off
- Light colour change via touch wheel
- Dimming of the set light colour
- Save buttons S1 / S2
- Selection buttons 25% / 50% / 75% / 100% brightness

| Article no. | Description | Price in € |
|-------------|--|------------|
| 17518000 | TunableWhite set (controller incl. remote control) | 129.90 |
| 17511000 | TunableWhite controller | 64.90 |

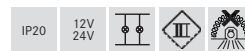

This item is subject to discount group 1.

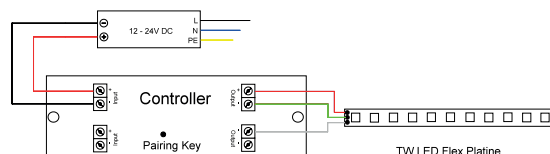



RGB radio control

RGB radio control for controlling RGB LED modules in the coloured light range.

Controller:

Voltage: 12-24 V DC,
 Power: max. 3 x 3.33 A,
 Power: max. 120 W / 240 W (12 V DC / 24 V DC),
 Control: negative (common anode),
 Control signal: PWM,
 Radio frequency: 869.5 MHz,
 Range (line of sight): up to 20 m,
 Ambient temperature (ta): 0 °C to +40 °C,
 Controller connection via screw terminals,
 Dimensions: L 145 x W 46.5 x H 16 mm,
 Material: plastic, includes strain relief,
 Controller per remote control: max. 4 (with optimum radio connection)

Remote control:

Voltage (battery): 4.5 V DC – 3 x AAA (not included),
 Radio frequency: 869.5 MHz, transmission power (Ps) < 0 dBm,
 Range (line of sight): up to 20 m,
 Ambient temperature (ta): 0 °C to +40 °C,
 Dimensions: L 120 x W 48 x H 18 mm,
 Material: plastic

Range of functions:

- On / Off
- RGB colour change via touch wheel
- Dimming buttons for red / green / blue
- Colour gradient: Start / Stop
- Colour gradient: speed

| Article no. | Description | Price in € |
|-------------|---|------------|
| 18233000 | RGB set (controller incl. remote control) | 136.90 |
| 17511000 | RGB controller | 64.90 |

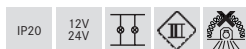

This item is subject to discount group 1.

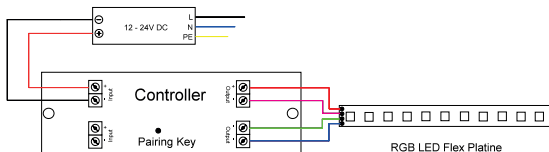

RGBW radio control

RGBW radio control for controlling RGBW LED modules for colour and white light.

Controller:

Voltage: 12-24 V DC,
 Power: max. 4 x 2.5 A,
 Power: max. 120 W / 240 W (12 V DC / 24 V DC),
 Control: negative (common anode),
 Control signal: PWM,
 Radio frequency: 869.5 MHz,
 Range (line of sight): up to 20 m,
 Ambient temperature (ta): 0 °C to +40 °C,
 Controller connection via screw terminals,
 Dimensions: L 145 x W 46.5 x H 16 mm,
 Material: plastic, includes strain relief,
 Controller per remote control: max. 4 (with optimum radio connection)

Remote control:

Voltage (battery): 4.5 V DC – 3 x AAA (not included),
 Radio frequency: 869.5 MHz, transmission power (Ps) < 0 dBm,
 Range (line of sight): up to 20 m,
 Ambient temperature (ta): 0 °C to +40 °C,
 Dimensions: L 120 x W 48 x H 18 mm,
 Material: plastic

Range of functions:

- On / Off
- White light selection button (ww / nw / w)
- RGB colour change via touch wheel
- Dimming buttons for red / green / blue / white
- Dimming of the set light colour
- Save buttons S1 / S2
- Colour gradient: Start / Stop
- Colour gradient: speed

| Article no. | Description | Price in € |
|-------------|--|------------|
| 18223000 | RGBW set (controller incl. remote control) | 139.90 |
| 18220000 | RGBW controller | 74.90 |

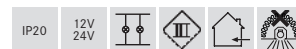

This item is subject to discount group 1.

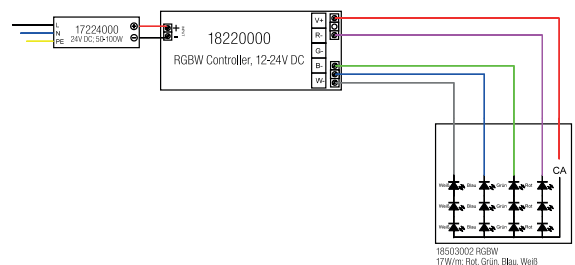



Radio system controller for 1-5 channel operation

Universal radio system controller for controlling 1-5-channel LED modules.

Possible control variants:

RGB + TunableWhite

Radio system controller 18190000:

Voltage: 12-24 V DC,
 Power: max. 5 x 2.0 A, 4 x 2.5 A, 3 x 3.33 A, 2 x 5.0 A, 1 x 5.0 A,
 Power: max. 120 W / 240 W (12 V DC / 24 V DC),
 Control: negative (common anode),
 Control signal: PWM,
 Radio frequency: 869.5 MHz,
 Range (line of sight): up to 20 m,
 Ambient temperature (ta): 0 °C to +40 °C,
 Dimensions: L 170 x W 59 x H 29 mm,
 Material: plastic, includes strain relief,
 Controller per remote control: max. 4 (with optimum radio connection)

Compatible with:

Remote control RGB + TW: 18205000
 Further functions for the above components can be found in the respective product description.

You can find the corresponding 12 / 24 V power supply units from page 168 / 170.

| Article no. | Description | Price in € |
|-------------|----------------------|------------|
| 18190000 | 5-channel controller | 190.90 |



This item is subject to discount group 1.

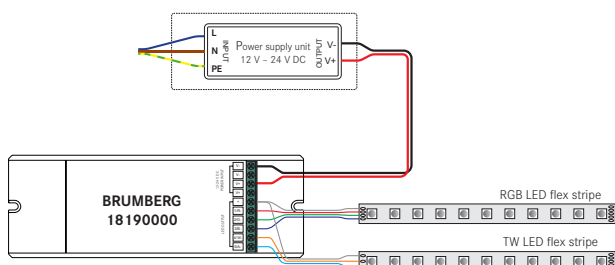

RGB-TW remote control for 18190000

RGB+TW remote control for controlling 5-channel LED modules with RGB and TunableWhite.

Voltage (battery): 4.5 V DC – 3 x AAA (not included),
 Radio frequency: 869.5 MHz, transmission power (Ps) < 0 dBm,
 Range (line of sight): up to 20 m,
 Ambient temperature (ta): 0 °C to +40 °C,
 Dimensions: L 153 x W 52 x H 19 mm,
 Material: plastic, includes wall bracket

Range of functions:

- On / Off
- RGB+TW colour change via touch wheel and slider
- White light selection button (ww / nw / w)
- Dimming buttons for red / green / blue / white
- Colour gradient: Start / Stop
- Colour gradient: speed
- Dimming of the set light colour via touch field
- Save button S1 to S4
- Controller selection buttons for zones 1 to 4

Compatible with radio system controller 18190000, please refer to the product description for further functions.

| Article no. | Price in € |
|-------------|------------|
| 18205000 | 206.90 |



This item is subject to discount group 1.



RGB+TW radio wall panel for 18190000

NEW

Recessed mounting, wall mounting. RGB+TW radio wall panel for controlling RGB+TW LED modules for colour and dynamic white light.

Nominal voltage: 110-230 V AC 50 Hz,
 Power consumption: 15 mA.
 Radio frequency: 869.5 MHz, transmission power (Ps) < 0 dBm,
 Range (line of sight): up to 20 m,
 Ambient temperature (ta): 0 °C to +40 °C,
 Connection via screw terminals,
 Installation in device box (flush-mounted),
 Installation depth in device box: 20 mm,
 External dimensions: L 86 x W 86 x H 31 mm,
 Projection: 12 mm,
 Material: glass / plastic,
 Controller per wall panel: max. 4 (with optimum radio connection)

Range of functions:

- On / Off
- RGB colour change via touch-slide line
- TW colour setting via touch-slide line
- Dimming button for red / green / blue
- Dimming button for TunableWhite
- Colour gradient: Start / Stop

Compatible with radio system controller 18190000, please refer to the product description for further functions.

Mounting type: recessed mounting, mounting location: wall mounting,
 Degree of protection: according to DIN EN 60529: IP20, protection class: (EN 61140) II,
 Voltage: 230V AC 50Hz.

| Article no. | Colour | Price in € |
|-------------|--------|------------|
| 18206070 | white | 184.90 |

IP20



This item is subject to discount group 1.

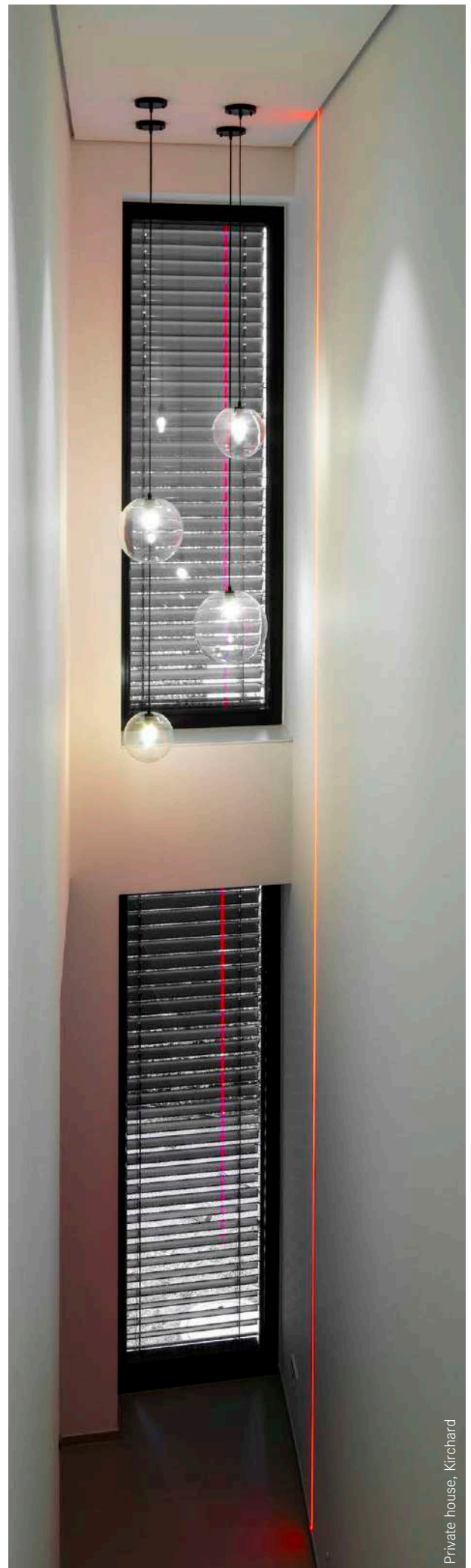



LED dimmer 12-24 V DC, Casambi dimmable

NEW

LED dimmer 12-24 V DC, Casambi dimmable.

Control via Casambi app.

Access the LEDs directly via smartphone and Bluetooth.

Possible control variants:

The Casambi 4-channel PWM dimmer can control up to four channels and is therefore ideal for QUALITYFLEX ONE, Select, Select HE, COB-Vision as well as TunableWhite, RGB and RGBW applications.

Multiple devices automatically form a mesh network that can be controlled from any point. These networks communicate wirelessly directly with the smartphone or tablet. This means that no external gateway or wireless LAN network is required.

The device can be set for different operating modes.

Separate channels: output 1-4, max. 6A,

TunableWhite: output 1+2, max. 6A,

RGBW: output 1-4, max. 6A

An external power supply (24 V DC) is required for operation.

Degree of protection on the room side: according to DIN EN 60529:

IP20,

Protection class: (EN 61140) III,

Voltage: 12-24 V, power: 144 W,

Type of dimming: Casambi,

Cross-section: 0.75 - 1.5 mm²,

Ambient temperature (ta): -20 to +45 °C,

Dimensions: L 73 x W 30 x H 18 mm,

Material: plastic

| Article no. | Description | Price in € |
|-------------|----------------------|------------|
| 18170000 | 4-channel LED dimmer | 207.90 |



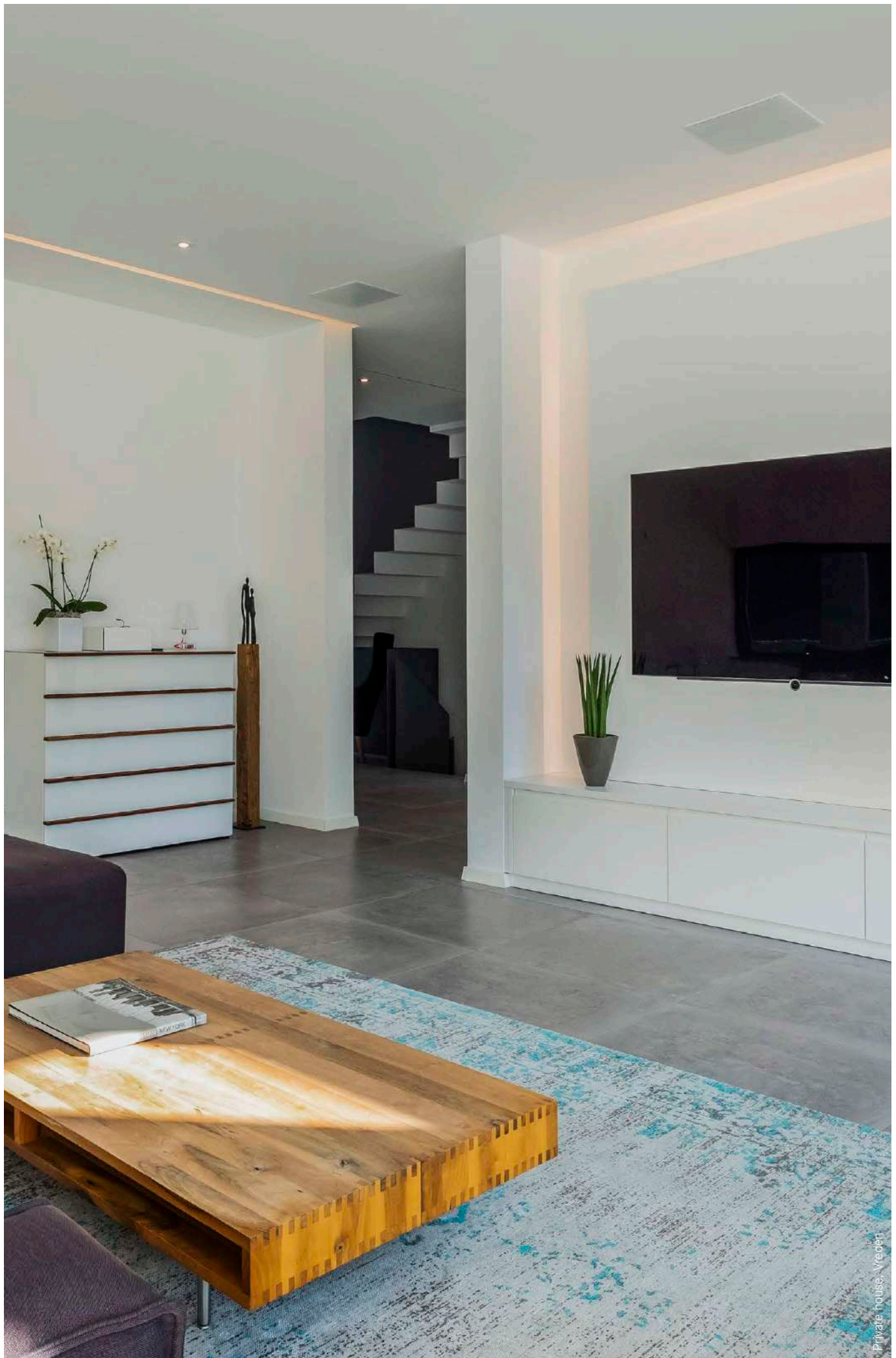

Private house, Vrejen



Radio system controller for 1-4 channel operation

Universal radio system controller for controlling 1-4-channel LED modules.

Possible control variants:

White light, TunableWhite, RGB, RGBW

Compatible with:

Remote control white light: 18199000, 18202000,
 TunableWhite remote control: 18198000, 18201000,
 Remote control RGB: 18197000, 18200000,
 Remote control RGBW: 18196000, 18194070 or 18194080.

Further functions for the above components can be found in the respective product description.

Radio system controller 18192000:

Voltage: 12-24 V DC,
 Power: max. 4 x 2.5 A,
 Power: max. 120 W / 240 W (12 V DC / 24 V DC),
 Control: negative (common anode),
 Control signal: PWM,
 Radio frequency: 869.5 MHz,
 Range (line of sight): up to 20 m,
 Ambient temperature (ta): 0 °C to +40 °C,
 Controller connection via screw terminals,
 Dimensions: L 160 x W 45 x H 18 mm,
 material: plastic, includes strain relief,
 Controller per remote control: max. 4 (with optimum radio connection)

Controller for system expansion: 18195000 (wired):

Voltage: 12-24 V DC,
 Power: max. 4 x 2.5 A,
 Power: max. 120 W / 240 W (12 V DC / 24 V DC),
 Control: negative (common anode),
 Control signal: PWM,
 Ambient temperature (ta): 0 °C to +40 °C,
 Controller connection via screw terminals,
 Dimensions: L 160 x W 45 x H 18 mm,
 Material: plastic, includes strain relief

| Article no. | Description | Price in € |
|-------------|--|------------|
| 18192000 | Radio system controller | 164.90 |
| 18195000 | Controller for system expansion, wired | 86.90 |

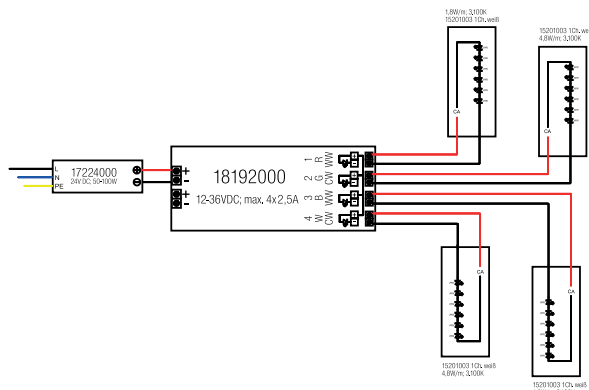



White light radio remote control for 18192000

White light radio remote control for controlling single-colour LED modules in the white light range or for controlling the dim2warm flex stripes 15313003 / 15363003 and 15309003 / 15369003.

Voltage (battery): 4.5 V DC – 3 x AAA (not included),
 Radio frequency: 869.5 MHz, transmission power (Ps) < 0 dBm,
 Range (line of sight): up to 20 m,
 Ambient temperature (ta): 0 °C to +40 °C,
 Dimensions: L 140 x W 48 x H 17 mm,
 Material: plastic, delivery incl. wall bracket

Range of functions:

- On / Off
- Dimming via touchwheel
- Save buttons S1 to S6
- Selection buttons 25% / 50% / 75% / 100% brightness
- Controller selection buttons for zones 1 to 6

Compatible with radio system controller 18192000, please refer to the product description for further functions.

TunableWhite radio remote control for 18192000

TunableWhite radio remote control for controlling two-colour LED modules in the white light range.

Voltage (battery): 4.5 V DC – 3 x AAA (not included),
 Radio frequency: 869.5 MHz, transmission power (Ps) < 0 dBm,
 Range (line of sight): up to 20 m,
 Ambient temperature (ta): 0 °C to +40 °C,
 Dimensions: L 140 x W 48 x H 17 mm,
 Material: plastic, includes wall bracket

Range of functions:

- On / Off
- Light colour change via touch wheel
- Dimming of the set light colour
- Save buttons S1 to S6
- Selection buttons 25% / 50% / 75% / 100% brightness
- Controller selection buttons for zones 1 to 6

Compatible with radio system controller 18192000, please refer to the product description for further functions.

| Article no. | Price in € |
|-------------|------------|
| 18199000 | 137.70 |

IP20

This item is subject to discount group 1.

| Article no. | Price in € |
|-------------|------------|
| 18198000 | 148.90 |

IP20

This item is subject to discount group 1.

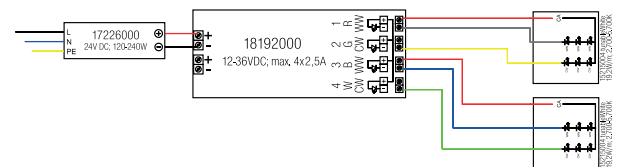
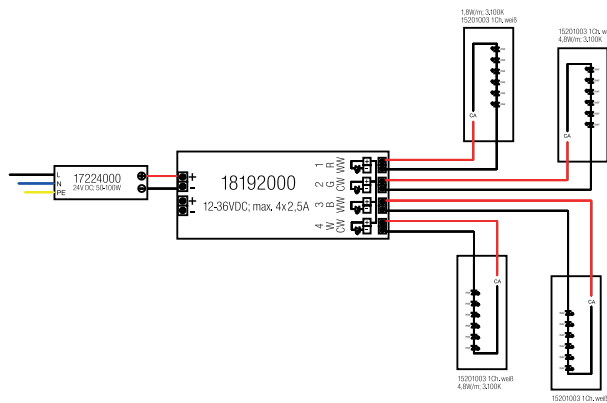



RGB radio remote control for 18192000

RGB radio remote control for controlling RGB LED modules in the coloured light range.

Voltage (battery): 4.5 V DC – 3 x AAA (not included),
 Radio frequency: 869.5 MHz, transmission power (Ps) < 0 dBm,
 Range (line of sight): up to 20 m,
 Ambient temperature (ta): 0 °C to +40 °C,
 Dimensions: L 140 x W 48 x H 17 mm,
 Material: plastic, includes wall bracket

Range of functions:

- On / Off
- RGB colour change via touch wheel
- Dimming buttons for red / green / blue
- Colour gradient: Start / Stop
- Colour gradient: speed
- Dimming of the set light colour
- Save button S
- Controller selection buttons for zones 1 to 6

Compatible with radio system controller 18192000, please refer to the product description for further functions.

| Article no. | Price in € |
|-------------|------------|
| 18197000 | 169.90 |

IP20

This item is subject to discount group 1.

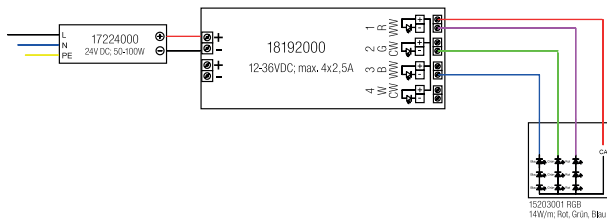



RGBW radio remote control for 18192000

RGBW radio remote control for controlling RGBW LED modules for colour and white light.

Voltage (battery): 4.5 V DC – 3 x AAA (not included),
 Radio frequency: 869.5 MHz, transmission power (Ps) < 0 dBm,
 Range (line of sight): up to 20 m,
 Ambient temperature (ta): 0 °C to +40 °C,
 Dimensions: L 152 x W 52 x H 19 mm,
 Material: plastic, includes wall bracket

Range of functions:

- On / Off
- RGBW colour change via touch wheel
- White light selection button (ww / nw / w)
- Dimming buttons for red / green / blue / white
- Colour gradient: Start / Stop
- Colour gradient: speed
- Dimming of the set light colour via touch field
- Save button S1 to S4
- Controller selection buttons for zones 1 to 4

Compatible with radio system controller 18192000, please refer to the product description for further functions.



RGBW radio wall panel for 18192000

RGBW radio wall panel for controlling RGBW LED modules for colour and white light.

Nominal voltage: 110-230 V AC 50 Hz,
 Power consumption: 15 mA.
 Radio frequency: 869.5 MHz, transmission power (Ps) < 0 dBm,
 Range (line of sight): up to 20 m,
 Ambient temperature (ta): 0 °C to +40 °C,
 Connection via screw terminals,
 Installation in device box (flush-mounted),
 Installation depth in device box: 20 mm,
 External dimensions: L 86 x W 86 x D 12 mm,
 Material: glass / plastic,
 Controller per wall panel: max. 4 (with optimum radio connection)

Range of functions:

- On / Off
- RGB colour change via touch wheel
- Dimming buttons for red / green / blue / white
- Dimming of the set light colour
- Save button S
- Colour gradient: Start / Stop
- Colour gradient: speed

Compatible with radio system controller 18192000, please refer to the product description for further functions.

| Article no. | Price in € |
|-------------|------------|
| 18196000 | 185.90 |

IP20

This item is subject to discount group 1.

| Article no. | Colour | Price in € |
|-------------|--------|------------|
| 18194070 | white | 174.90 |
| 18194080 | black | 174.90 |



This item is subject to discount group 1.

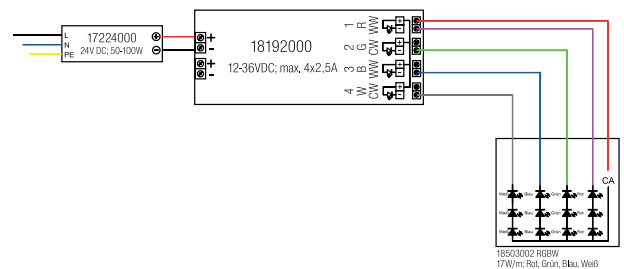
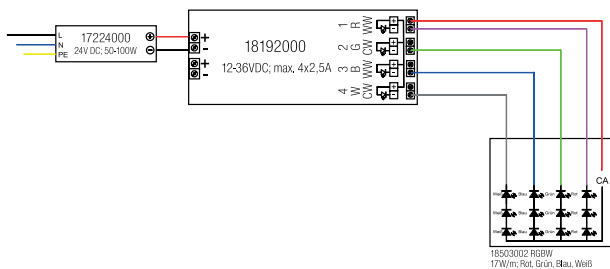

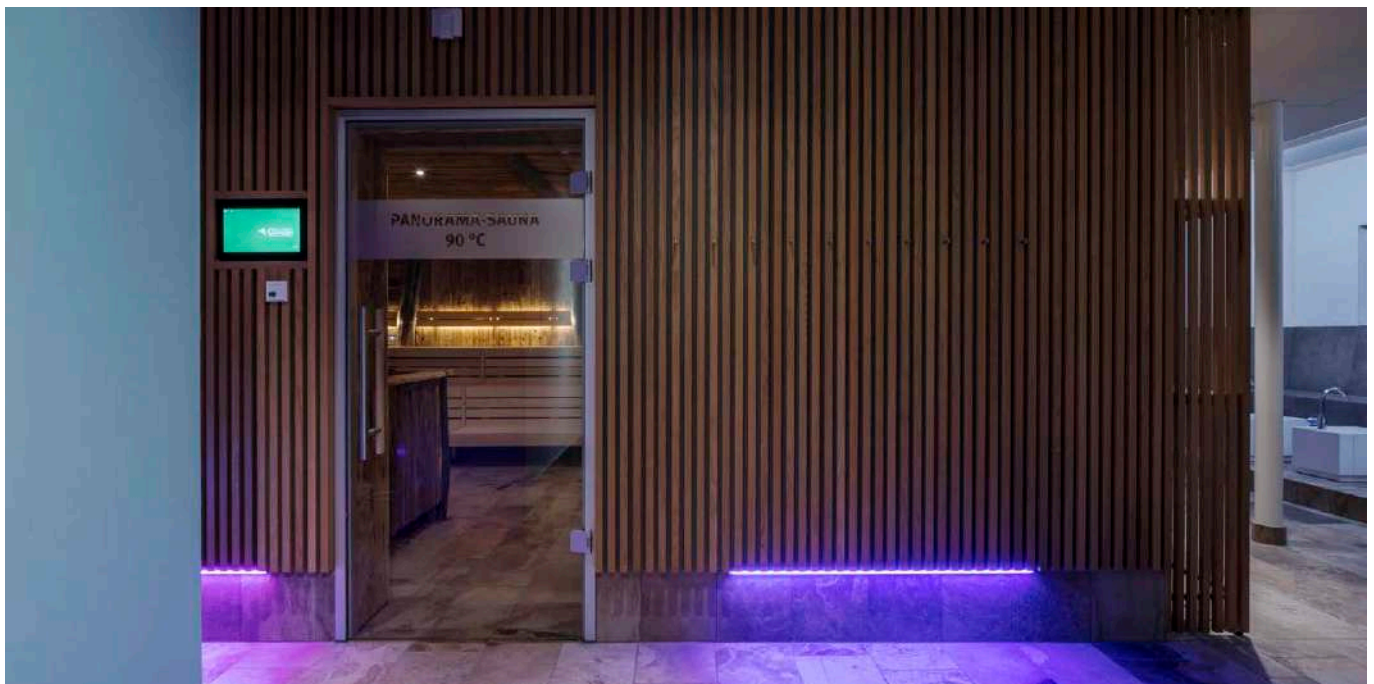
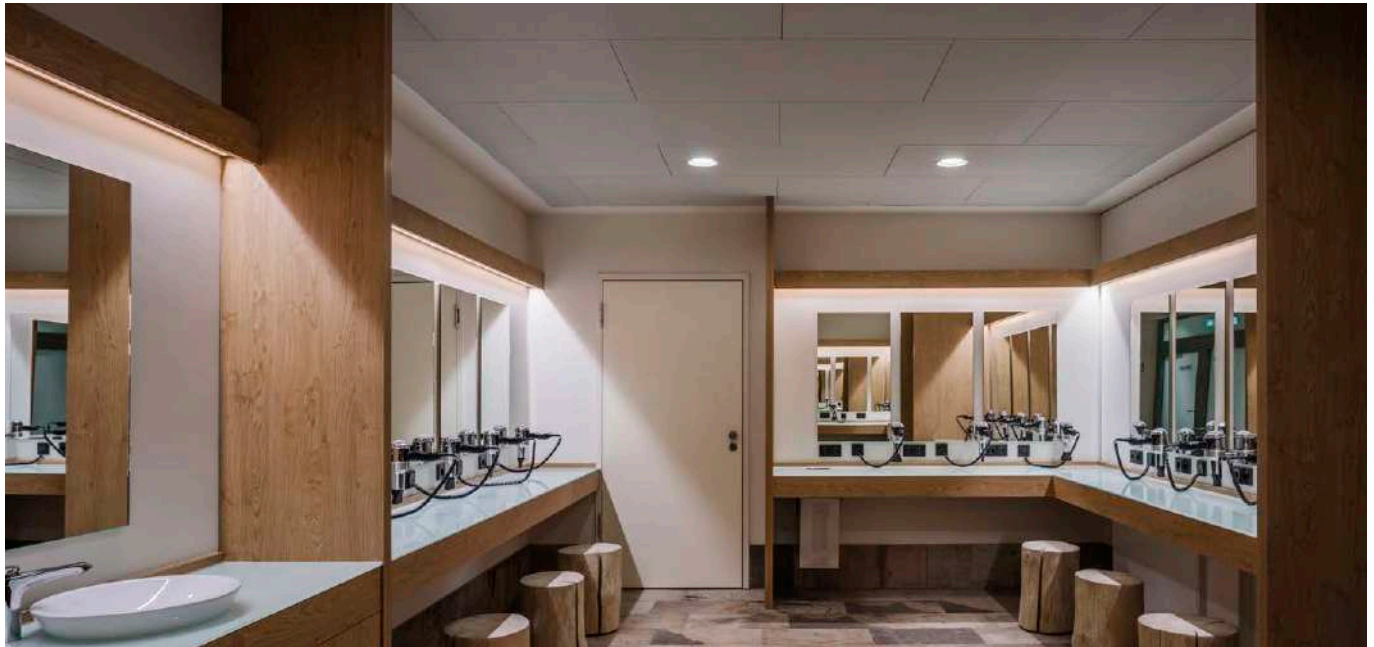
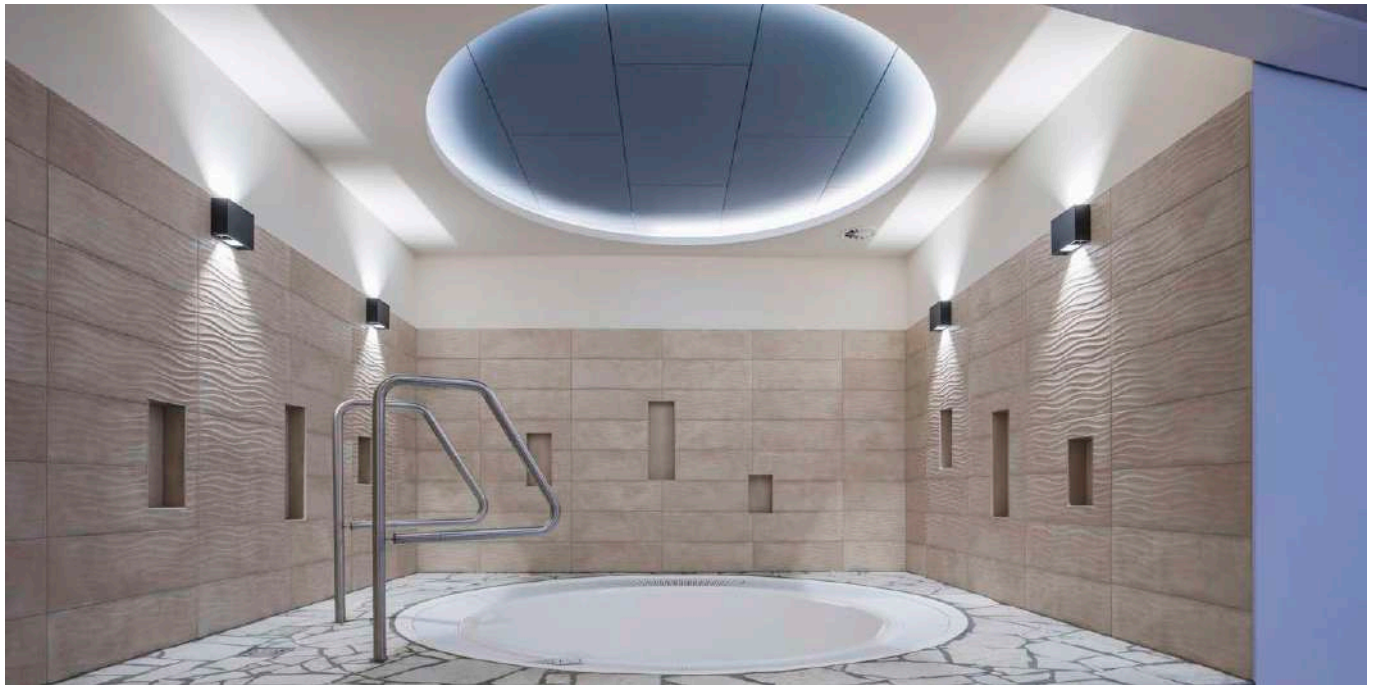

Eiswiese sauna area in Göttingen.

Relaxation in light and ambience.

Badeparadies Eiswiese is the largest swimming, leisure and recreational pool in Göttingen and southern Lower Saxony. Covering a total area of 8,400 m², it offers numerous attractions, e.g. sports and communication pools, white water channel, slides, various floor jets and a thermal brine hall.

An exclusive highlight is the 2,800 m² sauna area: five saunas at different temperatures, two steam saunas, a sanarium, a double sauna with wood firing set deep into the ground and the park-like sauna garden ensure deep physical and mental relaxation. Under the motto "Better, bigger, newer", the entire interior of the sauna area was extensively renovated and the outdoor area extended in 2020. Brumberg was chosen to provide the perfect lighting for the beauty treatment and was commissioned with the lighting concept.

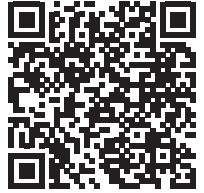

More information
for reference:

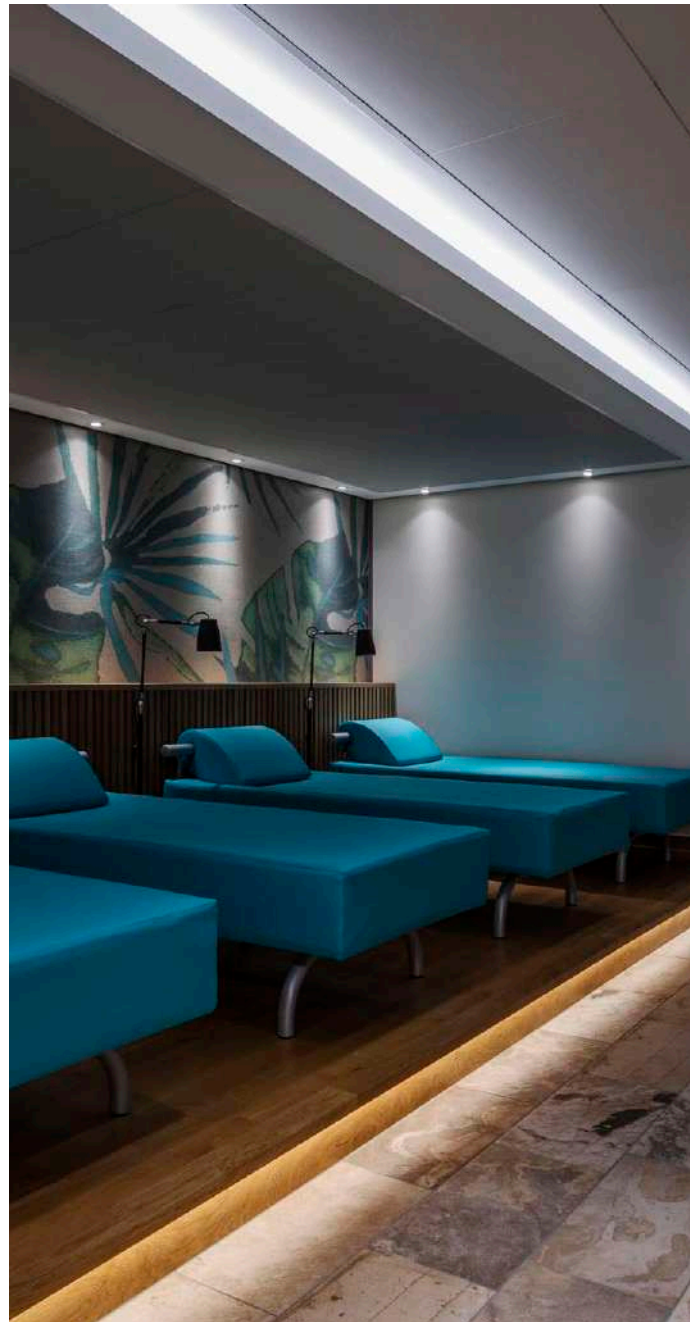
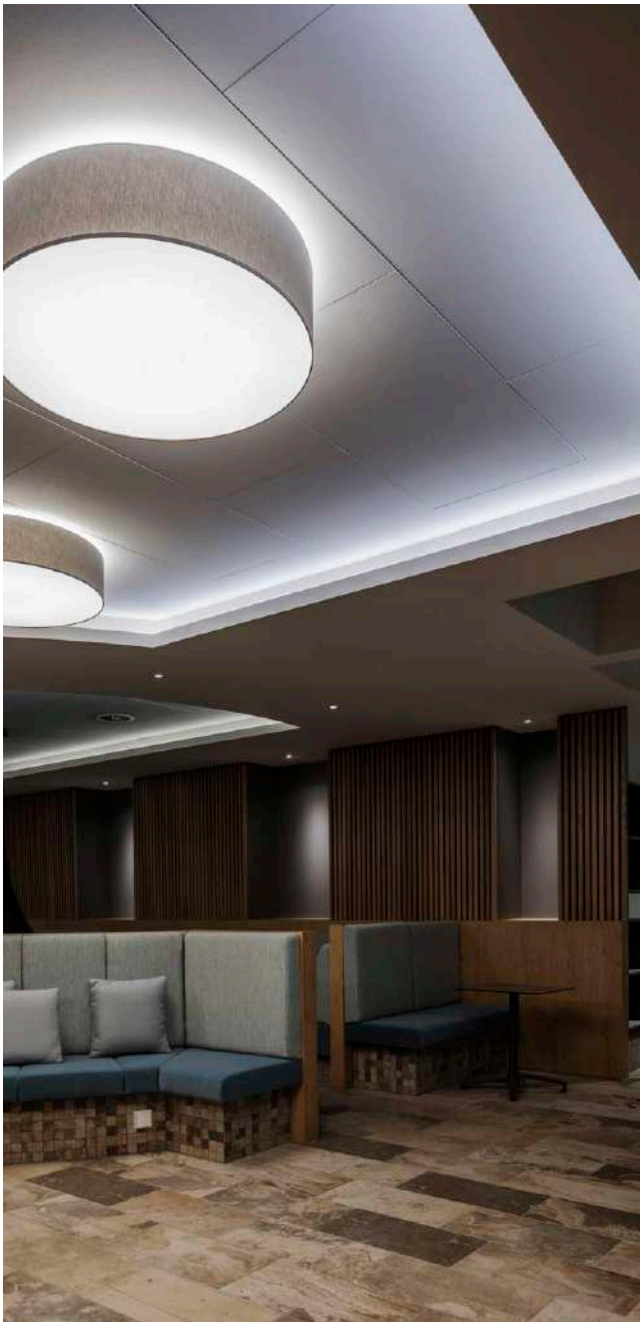



Gaienhofen Tourist Information Centre.

Experience Lake Constance.

The newly opened Gaienhofen Tourist Information Centre is located in the former town hall building, which has been renovated to make it more energy-efficient and given a modern wooden façade. This renovation was planned by architect Jörn Thamm, bauraum Konstanz. You will find more here than a simple tourist information centre: an experience-orientated multimedia presentation of the Lake Constance landscape, based on a concept by Prof. Herbert Moser, artxmedia.

The “Tiefenschärfe Bodensee” project provided high-resolution survey data and made it possible to realistically visualise the depths of Lake Constance, which are displayed in the blue vestibule in the entrance area and in the photo print of the floor. So you walk over a detailed map of the Untersee.

Light plays a special role in the interactive exhibition. The QUALITYFLEX COB-Vision LED flex stripes in combination with downlights were used to “softly” stage the room in order to emphasise the structure of Lake Constance in the exhibition.



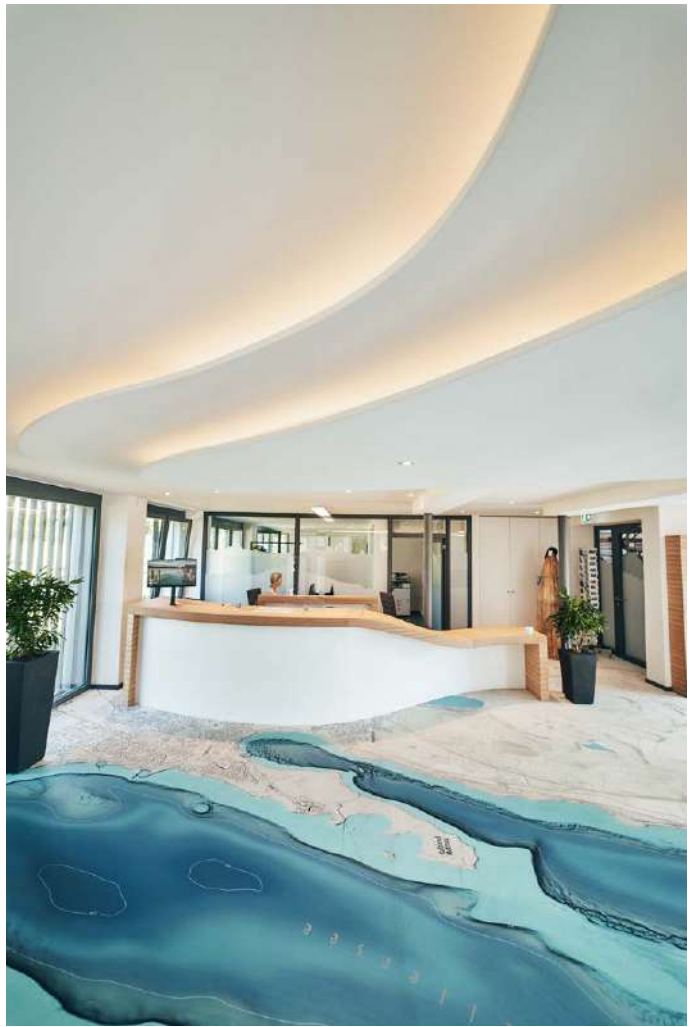

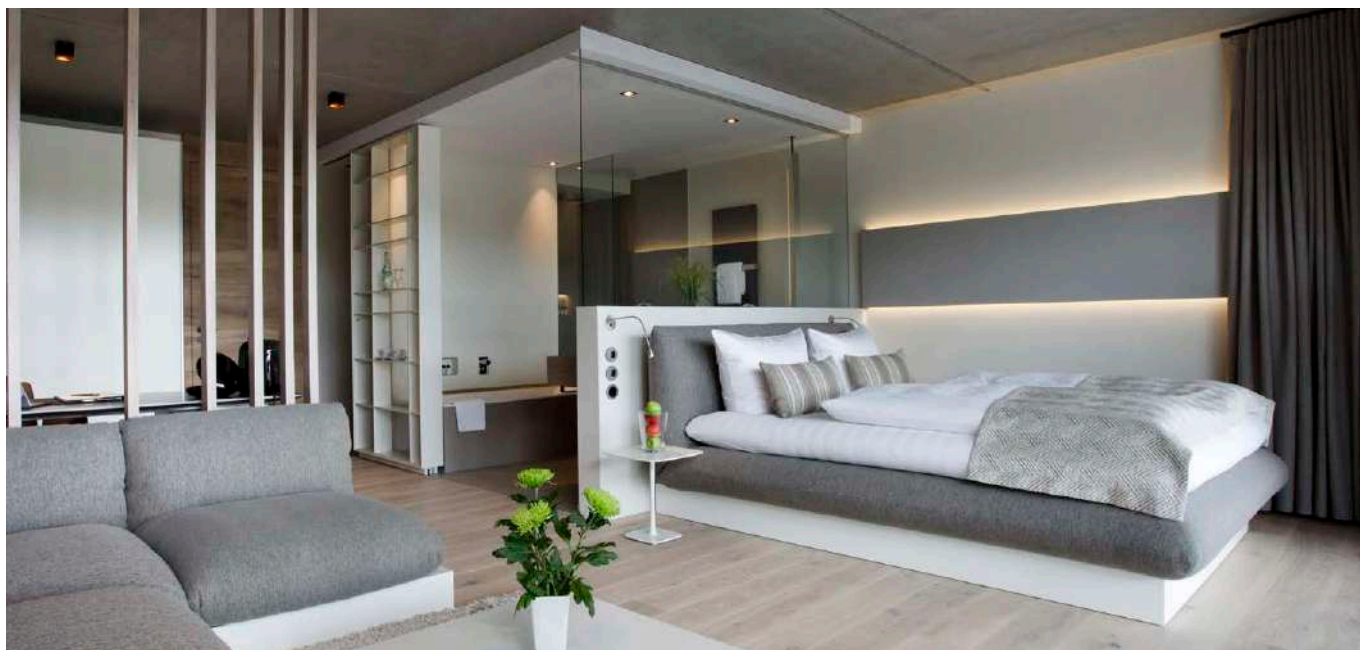

Hotel Seegarten.

Light. To arrive and relax.

How does one transform standard seminar rooms in an academy into lively learning landscapes? How is it possible to break out of rigid room concepts and equip rooms with flexibility in terms of utilisation and atmosphere? The Arnsberg architects Keggenhoff |Partner had to answer these questions in an exciting modernisation project for the Arnsberg Chamber of Industry and Commerce.

The existing seminar rooms at the Hellweg-Sauerland administration and business academy had to be redesigned so that they could be easily adapted for different purposes. Sliding walls instead of fixed walls initially created variability in the room size. In order to be equipped for a wide variety of occasions, from seminars and company workshops to evening events, they opted for an intelligent use of light and lighting.

Together with the client, architects and tradesmen from the region, Brumberg has illuminated the various areas of the hotel in such a way that guests and employees alike feel at ease. To this end, the Sauerland-based company has supported the interior design with its tasteful furnishings in terms of lighting technology and additionally staged it. Brumberg therefore opted for a combination of direct and indirect light. Basic lighting is provided by QUALITYFLEX LED flex stripes recessed into niches and ceilings. A bright and at the same time warm, cosy light that creates a relaxed basic atmosphere – especially in the wellness area.

The rooms are flanked by LED ceiling-mounted luminaires with a textured black housing and matt gold interior. These luminaires set accents with their warm light and illuminate the areas that need more light. Result: pleasant lighting scenarios have been created throughout all the rooms, making you forget stress and everyday life.

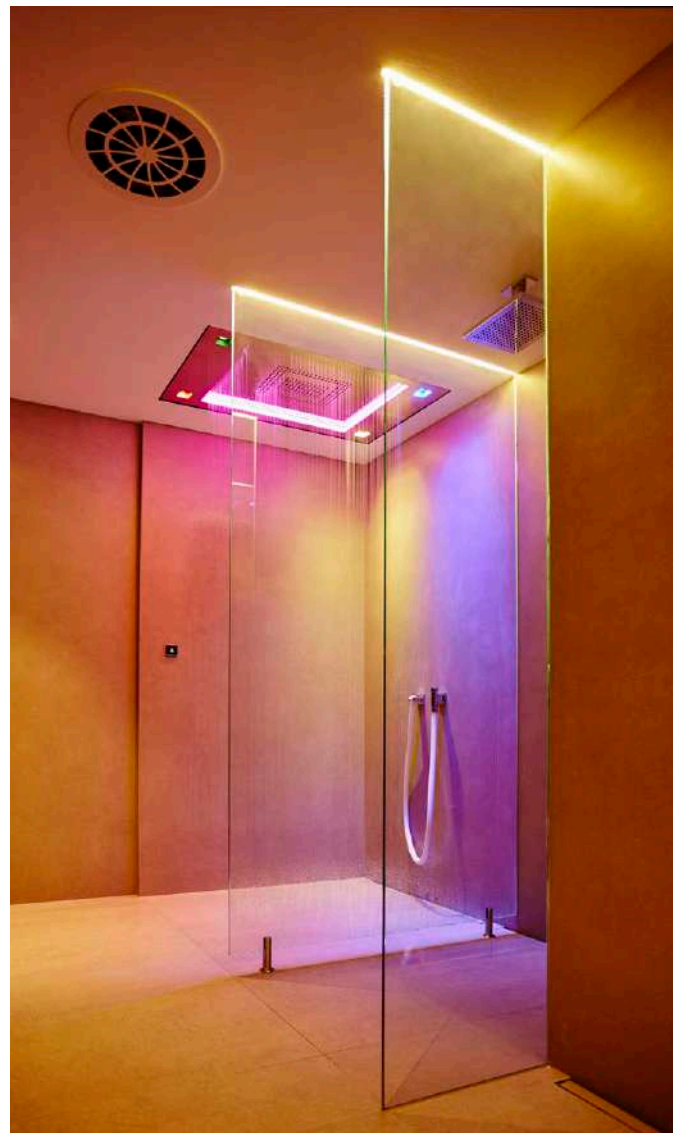
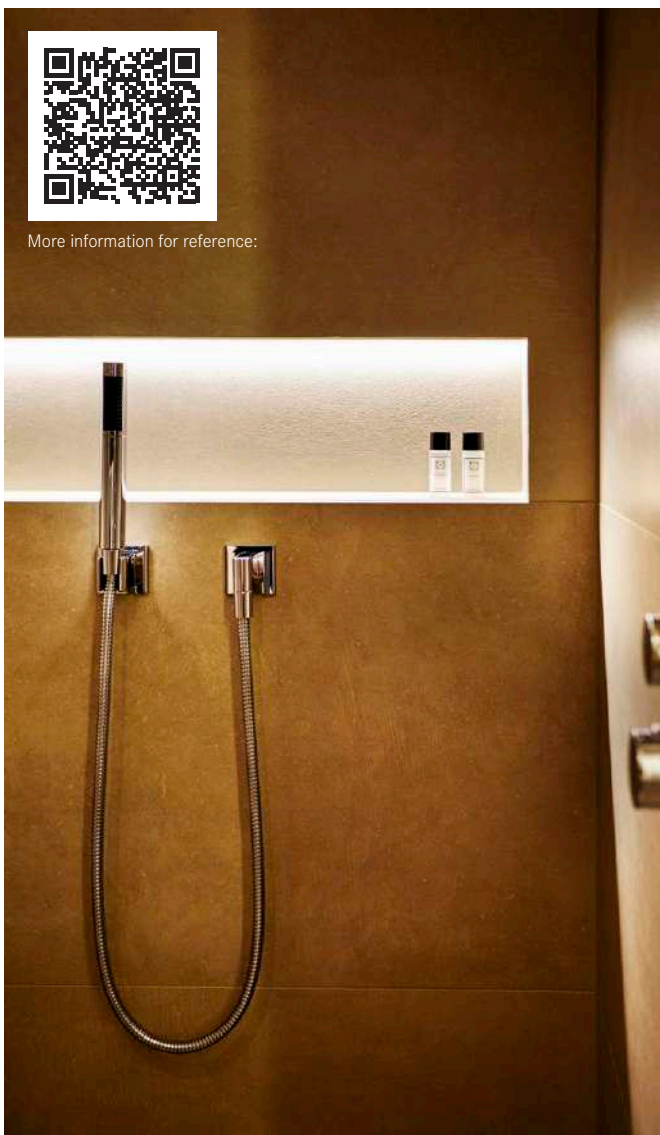



Hotel Innspire.

Smart control, more convenience

The Innspire Hotel Munich is a smart boutique and design hotel with 34 rooms, 6 suites and a high-quality spa and wellness area. The hotel offers its guests digitally networked entertainment and lighting solutions in the rooms and other areas of the hotel. Upon request, programmed scenarios such as “TV”, “Lights off”, “Relax” and “Work” can be called up via the tablet. The prestigious lounge and restaurant with wine bar impress with their modern furnishing concept, innovative lighting and culinary highlights.

The right light for every atmosphere.

The operator relies on synchronised functions and intelligent operating concepts in the Innspire Hotel. The guest can individually control the room furnishings, the entertainment system or the lighting. Lighting in particular fulfils an important role in the temporary home: light creates atmospheres, has an activating or relaxing effect and thus promotes productivity as well as periods of rest – depending on the guest's needs. As a lighting partner, Brumberg uses QUALITYFLEX Individual, dim2warm LED flex stripes to create the right ambience in the rooms as well as in the spa and wellness area of the hotel with intelligent solutions. Brumberg supports hotel guests in their daily routine with colour temperatures that can be adapted to their bio-rhythm.





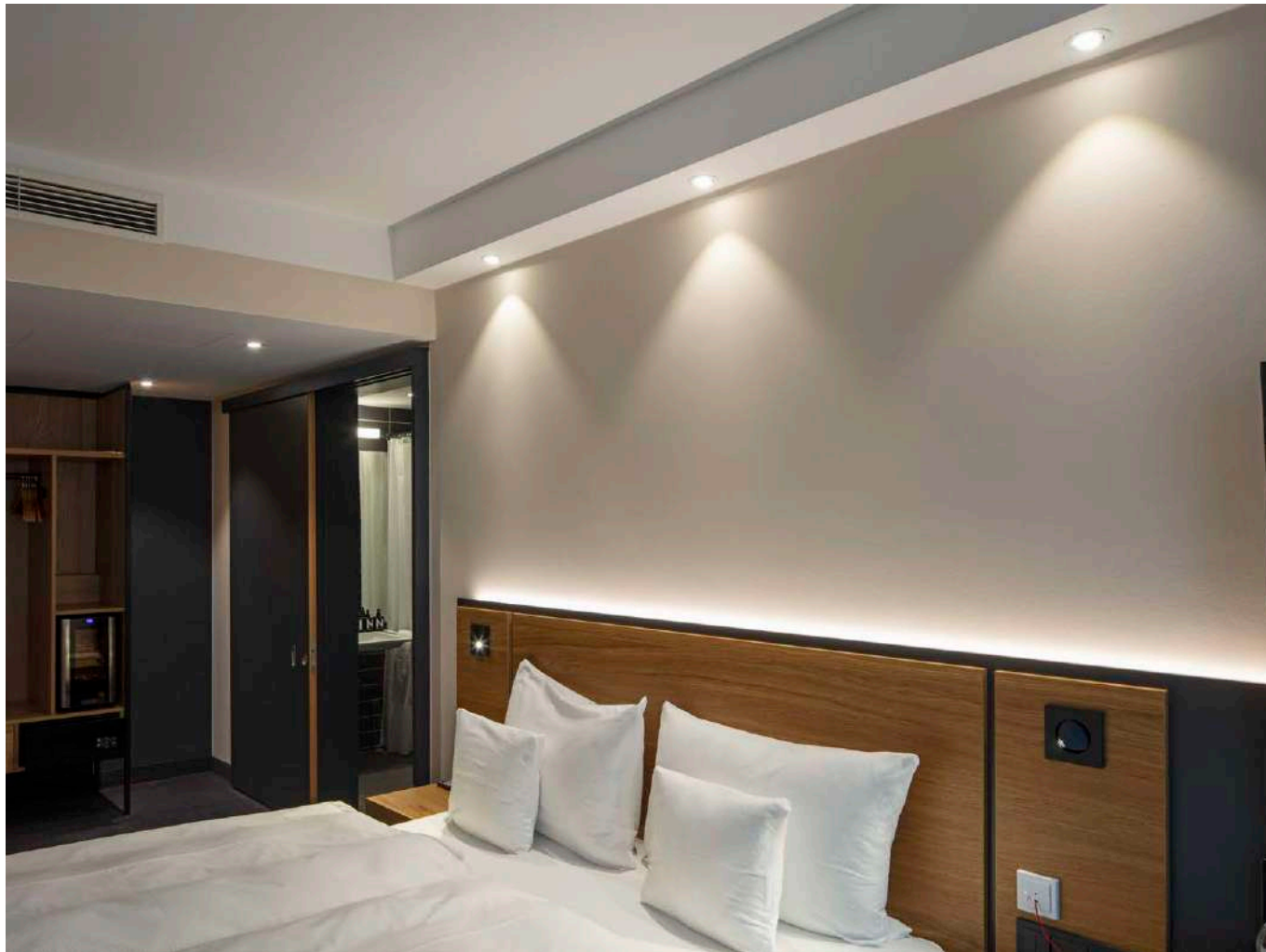

Ginn City & Lounge Ravensburg.

Indirect lighting plays a major role in perfectly setting the scene in rooms and at the same time creating good illumination and a special atmosphere.

The **redesign** of the 124 Ginn City Lounge rooms in Ravensburg has created a perfect place to relax. The attractive basic lighting was combined with discreet QUALITYFLEX LED flex stripes. The linear lighting concept has created an exciting room atmosphere that can be controlled as required.

The indirect lighting in the sleeping area creates atmospheric accents. Brumberg supplied LED flex stripes, LED recessed luminaires and control products for this project.

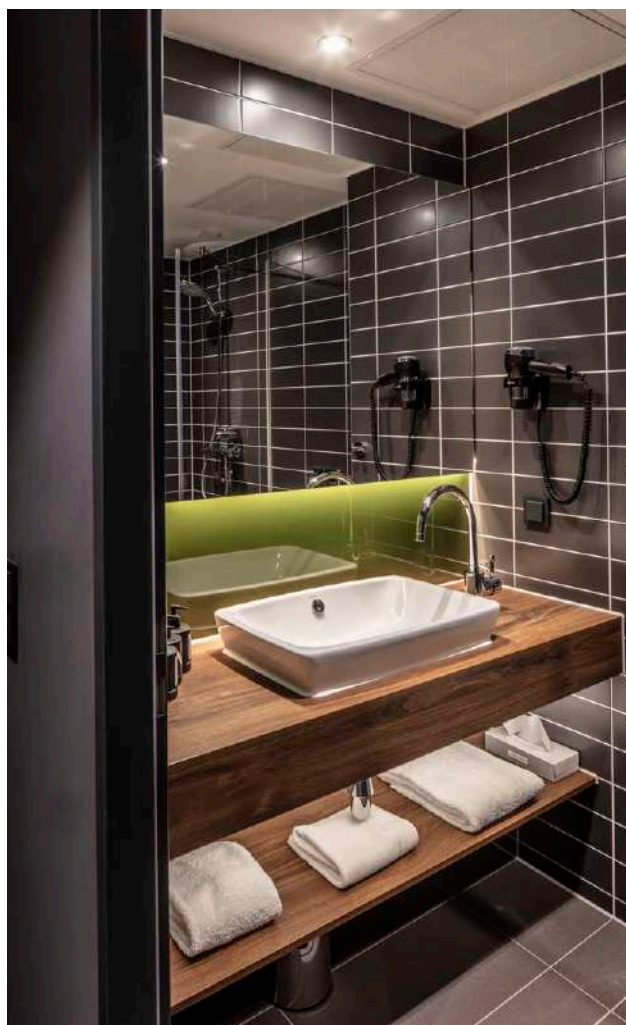

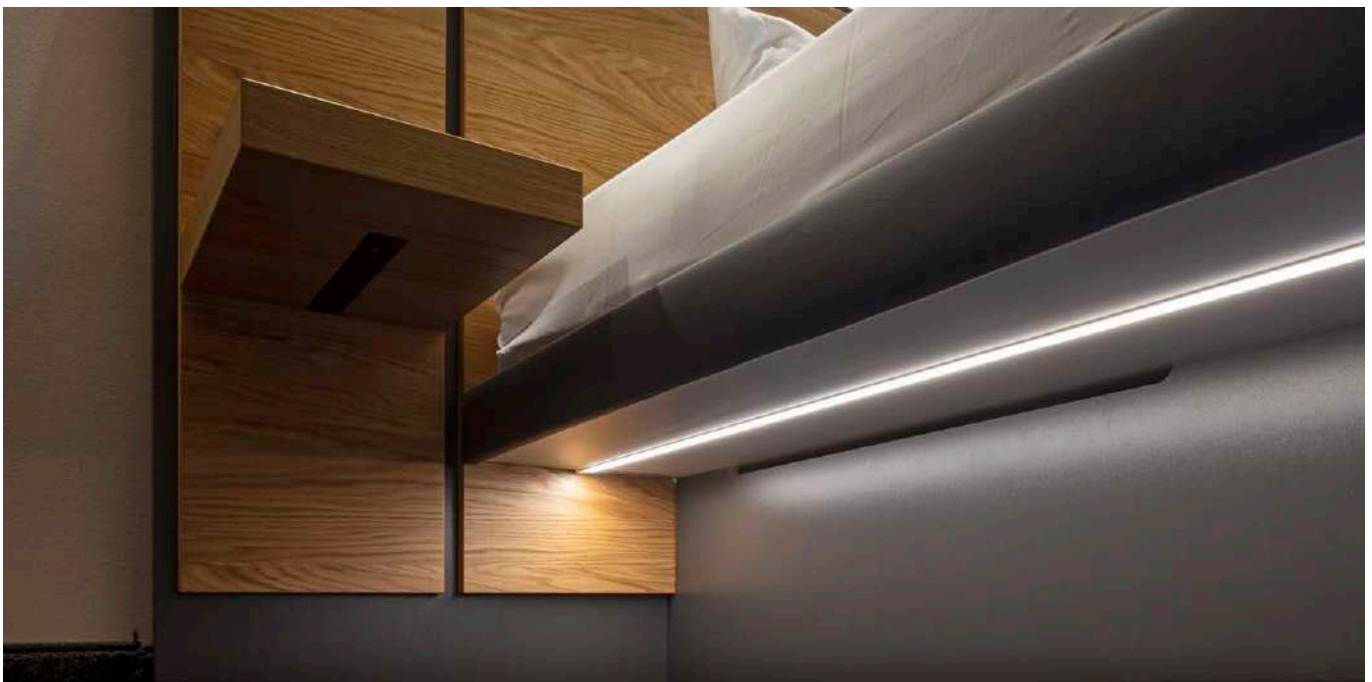





Private house, Coesfeld

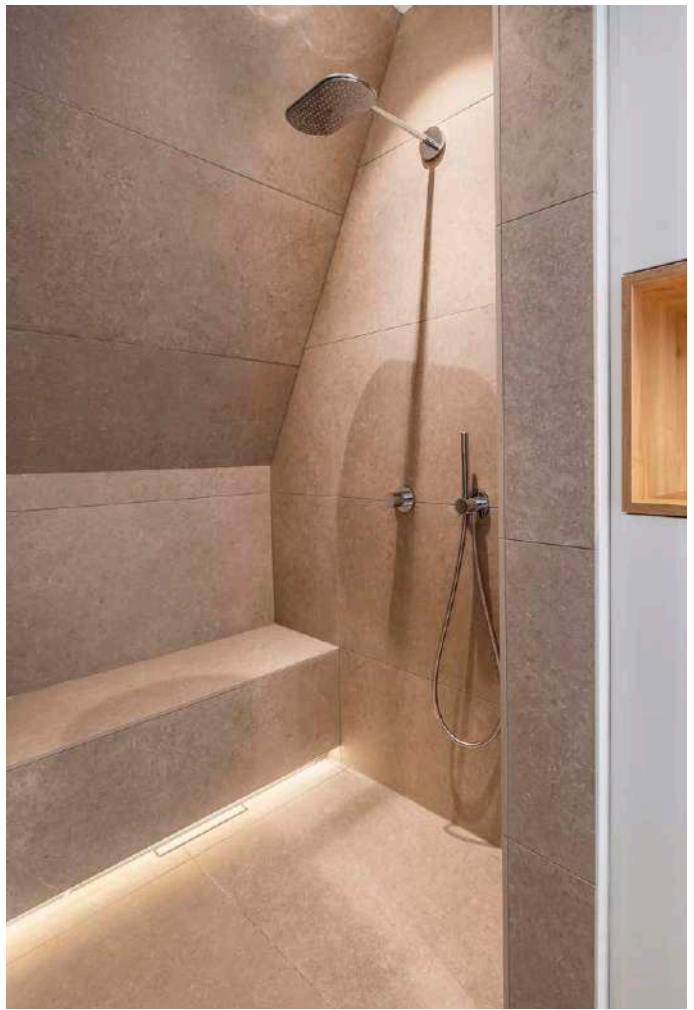



Outdoor lighting



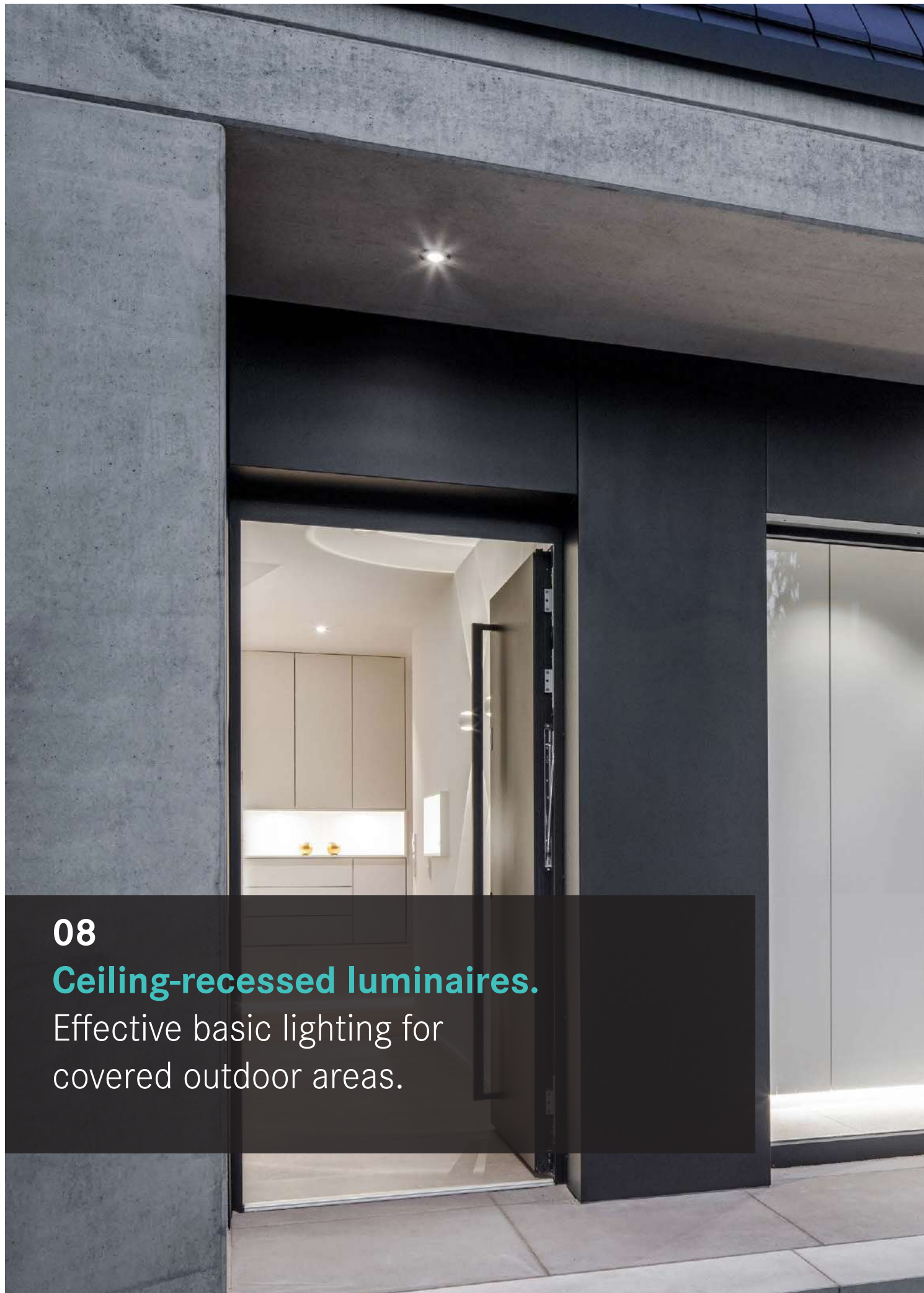

08

Ceiling-recessed luminaires.

Effective basic lighting for covered outdoor areas.



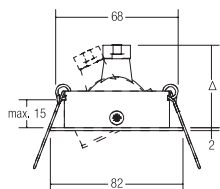

GILLAN-R recessed spotlight, V4A, GX5.3

Lamp: for LED retrofit lamp, lamp holder: GX5,3, power: max. 50 W, material: V4A stainless steel, supplied without snap ring

| Article no. | Colour | Price in € |
|-------------|--------------------|------------|
| 1180.22 | matt stainl. steel | 98.90 |

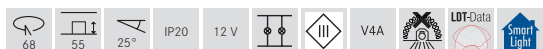

This item is subject to discount group 1.

GILLAN-R recessed spotlight, V4A, GU 10

Includes bracket with GU10 lamp holder for standard-compliant strain relief.

Lamp: for LED retrofit lamp, lamp holder: GU10, power: max. 50 W, material: stainless steel V4A

| Article no. | Colour | Price in € |
|-------------|--------------------|------------|
| 36147220 | matt stainl. steel | 105.90 |



This item is subject to discount group 1.

GILLAN-R LED recessed spotlight set, V4A, switchable

Set includes converter for 230 V mains supply, switchable, converter dimensions: L 68 x W 35 x H 21 mm

Lamp: LED, colour rendering: CRI > 80, power: 6 W, beam angle: 38°, material: V4A stainless steel / aluminium / glass / plastic

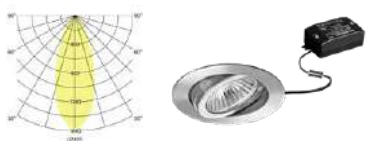

| Article no. | Colour | Luminous flux | Colour temp. | Price in € |
|-------------|--------------------|---------------|--------------|------------|
| 38147223 | matt stainl. steel | 680 lm | 3,000 K | 185.90 |

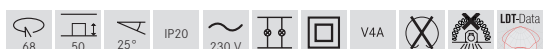

This item is subject to discount group 1.

GILLAN-R LED recessed spotlight set, V4A, trailing-edge phase dimmable

Set includes converter for 230 V mains supply, trailing-edge phase dimmable, converter dimensions: L 110 x W 50 x H 19 mm

Lamp: LED, colour rendering: CRI > 80, power: 6 W, beam angle: 38°, material: V4A stainless steel / aluminium / glass / plastic

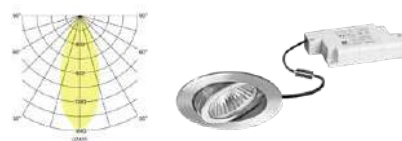

| Article no. | Colour | Lumin. flux | Colour temp. | Price in € |
|-------------|--------------------|-------------|--------------|------------|
| 39147223 | matt stainl. steel | 680 lm | 3,000 K | 190.90 |



This item is subject to discount group 1.

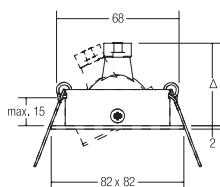

GILLAN-S recessed spotlight, V4A, GX5.3

Lamp: for LED retrofit lamp, lamp holder: GX5,3, power: max. 50 W, material: V4A stainless steel, supplied without snap ring

GILLAN-S recessed spotlight, V4A, GU10

Includes bracket with GU10 lamp holder for standard-compliant strain relief.

Lamp: for LED retrofit lamp, lamp holder: GU10, power: max. 50 W, material: stainless steel V4A

| Article no. | Colour | Price in € |
|-------------|--------------------|------------|
| 1181.22 | matt stainl. steel | 104.40 |

| Article no. | Colour | Price in € |
|-------------|--------------------|------------|
| 36148220 | matt stainl. steel | 112.90 |

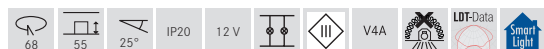

This item is subject to discount group 1.



This item is subject to discount group 1.

GILLAN-S LED recessed spotlight set, V4A, switchable

Set includes converter for 230 V mains supply, switchable, converter dimensions: L 68 x W 35 x H 21 mm

Lamp: LED, colour rendering: CRI > 80, power: 6 W, beam angle: 38°, material: V4A stainless steel / aluminium / glass / plastic

GILLAN-S LED recessed spotlight set, V4A, trailing-edge phase dimmable

Set includes converter for 230 V mains supply, trailing-edge phase dimmable, converter dimensions: L 110 x W 50 x H 19 mm

Lamp: LED, colour rendering: CRI > 80, power: 6 W, beam angle: 38°, material: V4A stainless steel / aluminium / glass / plastic



| Article no. | Colour | Lumin. flux | Colour temp. | Price in € |
|-------------|--------------------|-------------|--------------|------------|
| 38148223 | matt stainl. steel | 680 lm | 3,000 K | 190.90 |

| Article no. | Colour | Lumin. flux | Colour temp. | Price in € |
|-------------|--------------------|-------------|--------------|------------|
| 39148223 | matt stainl. steel | 680 lm | 3,000 K | 196.90 |

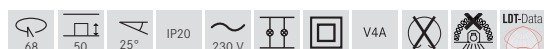

This item is subject to discount group 1.

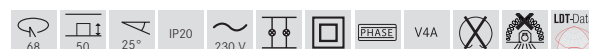

This item is subject to discount group 1.





STEAM-R recessed downlight, V4A, IP65, without LED module

All Brumberg MR16 LED modules can be used for the STEAM installation unit. The installation depth of the luminaire depends on the LED module used (here: 2 mm, plus the height of the LED module).

Lamp: For LED, power: max. 14 W, material: V4A stainless steel / aluminium / glass, includes LED module socket on the back

Associated LED modules and converters can be found in our main catalogue.

The LED module is not included in the scope of supply of the installation unit.

Note: Note the height of the lamp!

| Article no. | Colour | Price in € |
|-------------|--------------------|------------|
| 37005070 | white matt | 84.40 |
| 37005080 | matt black | 84.40 |
| 37005420 | matt stainl. steel | 87.60 |



IP65 when installed in closed ceilings (screw mounting)

This item is subject to discount group 1.



STEAM-R recessed downlight, V4A, IP54, without LED module

All Brumberg MR16 LED modules can be used for the STEAM installation unit. The installation depth of the luminaire depends on the LED module used (here: 2 mm, plus the height of the LED module).

Lamp: For LED, power: max. 14 W, material: V4A stainless steel / aluminium / glass, includes LED module socket on the back

Associated LED modules and converters can be found in our main catalogue.

The LED module is not included in the scope of supply of the installation unit.

Note: Note the height of the lamp!

| Article no. | Colour | Price in € |
|-------------|--------------------|------------|
| 37006070 | white matt | 90.10 |
| 37006080 | matt black | 90.10 |
| 37006420 | matt stainl. steel | 94.90 |



IP54 when installed in closed ceilings (spring mounting)

This item is subject to discount group 1.

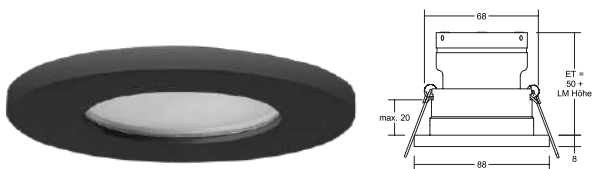

STEAM-S recessed downlight, V4A, IP65, without LED module

All Brumberg MR16 LED modules can be used for the STEAM installation unit. The installation depth of the luminaire depends on the LED module used (here: 50 mm, plus the height of the LED module).

Lamp: For LED, power: LED, max. 14 W, material: V4A stainless steel / aluminium / glass, includes LED module socket on the back

Associated LED modules and converters can be found in our main catalogue.

The LED module is not included in the scope of supply of the installation unit.

Note: Note the height of the lamp!

| Article no. | Colour | Price in € |
|-------------|--------------------|------------|
| 37015070 | white matt | 87.40 |
| 37015080 | matt black | 87.40 |
| 37015420 | matt stainl. steel | 89.60 |



IP65 when installed in closed ceilings (screw mounting)

Tall version with air buffer e.g. for hot sauna areas.

This item is subject to discount group 1.



STEAM-S recessed downlight, V4A, IP54, without LED module

All Brumberg MR16 LED modules can be used for the STEAM installation unit. The installation depth of the luminaire depends on the LED module used (here: 50 mm, plus the height of the LED module).

Lamp: For LED, power: LED, max. 14 W, material: V4A stainless steel / aluminium / glass, includes LED module socket on the back

Associated LED modules and converters can be found in our main catalogue.

The LED module is not included in the scope of supply of the installation unit.

Note: Note the height of the lamp!

| Article no. | Colour | Price in € |
|-------------|--------------------|------------|
| 37016070 | white matt | 92.60 |
| 37016080 | matt black | 92.60 |
| 37016420 | matt stainl. steel | 97.30 |



IP54 when installed in closed ceilings (spring mounting)

Tall version with air buffer e.g. for hot sauna areas.

This item is subject to discount group 1.

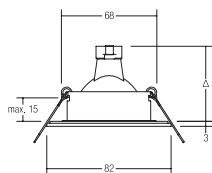

ITANSA-R recessed downlight, V4A, IP54, GX5.3

NEW

Lamp: for LED retrofit lamp, lamp holder: GX5,3, power: max. 35 W, material: V4A stainless steel / aluminium / glass

| Article no. | Colour | Price in € |
|-------------|-----------------------|------------|
| 26004070 | white matt | 71.30 |
| 26004080 | NEW matt black | 71.30 |
| 26004220 | matt stainl. steel | 71.30 |



IP54 when installed in closed ceilings
This item is subject to discount group 1.

ITANSA-R recessed downlight, V4A, IP54, GU10

NEW

Includes bracket with GU10 lamp holder for standard-compliant strain relief.

Lamp: for LED retrofit lamp, lamp holder: GU10, power: max. 35 W, material: V4A stainless steel / aluminium / glass

| Article no. | Colour | Price in € |
|-------------|-----------------------|------------|
| 36004070 | white matt | 81.90 |
| 36004080 | NEW matt black | 81.90 |
| 36004220 | matt stainl. steel | 81.90 |

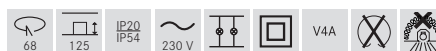

IP54 when installed in closed ceilings
This item is subject to discount group 1.

ITANSA-R LED recessed downlight set BB15, V4A, IP54, switchable

NEW

Set includes converter for 230 V mains supply, switchable, converter dimensions: L 68 x W 35 x H 21 mm

Lamp: LED, colour rendering: CRI > 80, power: 6 W, beam angle: 38°, material: V4A stainless steel / aluminium / glass / plastic



| Article no. | Colour | Lumin. flux | Colour temp. | Price in € |
|-------------|-----------------------|-------------|--------------|------------|
| 38375073 | white matt | 680 lm | 3,000 K | 102.90 |
| 38375083 | NEW matt black | 680 lm | 3,000 K | 102.90 |
| 38375423 | matt stainl. steel | 680 lm | 3,000 K | 102.90 |

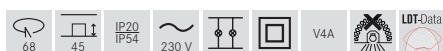

IP54 when installed in closed ceilings
This item is subject to discount group 1.

ITANSA-R LED recessed downlight set BB 15, **NEW** V4A, IP54, trailing-edge phase dimmable

Set includes converter for 230 V mains supply, trailing-edge phase dimmable, converter dimensions: L 110 x W 50 x H 19 mm

Lamp: LED, colour rendering: CRI > 80, power: 6 W, beam angle: 38°, material: V4A stainless steel / aluminium / glass / plastic

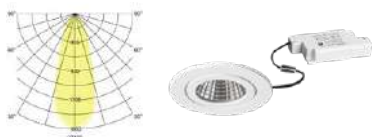

| Article no. | Colour | Lumin. flux | Colour temp. | Price in € |
|---------------------|--------------------|-------------|--------------|------------|
| 39375073 | white matt | 680 lm | 3,000 K | 107.30 |
| 39375083 NEW | matt black | 680 lm | 3,000 K | 107.30 |
| 39375423 | matt stainl. steel | 680 lm | 3,000 K | 107.30 |

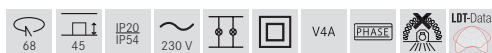

IP54 when installed in closed ceilings
This item is subject to discount group 1.

ITANSA-R LED recessed downlight set BB 15, **NEW** V4A, IP54, trailing-edge phase dimmable, with connection box

Set includes converter for 230 V mains supply, trailing-edge phase dimmable, converter dimensions: L 110 x W 50 x H 19 mm

Lamp: LED, colour rendering: CRI > 80, power: 6 W, beam angle: 38°, material: V4A stainless steel / aluminium / glass / plastic, includes 3-pole connection box



| Article no. | Colour | Lumin. flux | Colour temp. | Price in € |
|---------------------|--------------------|-------------|--------------|------------|
| 39475073 | white matt | 680 lm | 3,000 K | 108.90 |
| 39475083 NEW | matt black | 680 lm | 3,000 K | 108.90 |
| 39475423 | matt stainl. steel | 680 lm | 3,000 K | 108.90 |

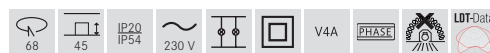

IP54 when installed in closed ceilings
This item is subject to discount group 1.

ITANSA-R LED recessed downlight set BB 15, **NEW** V4A, IP54 trailing-edge phase dimmable (round converter)

Set includes round converter for 230 V mains supply, trailing-edge phase dimmable, converter dimensions: D 51 x H 24 mm

Lamp: LED, colour rendering: CRI > 80, power: 6 W, beam angle: 38°, material: V4A stainless steel / aluminium / glass / plastic

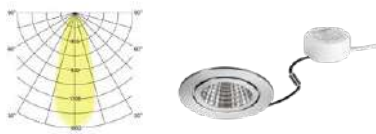

| Article no. | Colour | Lumin. flux | Colour temp. | Price in € |
|---------------------|--------------------|-------------|--------------|------------|
| 40375073 | white matt | 680 lm | 3,000 K | 113.90 |
| 40375083 NEW | matt black | 680 lm | 3,000 K | 113.90 |
| 40375423 | matt stainl. steel | 680 lm | 3,000 K | 113.90 |

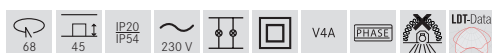

IP54 when installed in closed ceilings
This item is subject to discount group 1.

ITANSA-R LED recessed downlight set BB 15, **NEW** V4A, IP54, DALI dimmable, with connection box

Set includes converter for 230 V mains supply, DALI-2 dimmable, converter dimensions: L 130 x W 42 x H 22 mm

Lamp: LED, colour rendering: CRI > 80, power: 6 W, beam angle: 38°, material: V4A stainless steel / aluminium / glass / plastic, includes 5-pole connection box

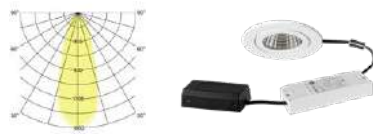

| Article no. | Colour | Lumin. flux | Colour temp. | Price in € |
|---------------------|--------------------|-------------|--------------|------------|
| 41475073 | white matt | 680 lm | 3,000 K | 151.90 |
| 41475083 NEW | matt black | 680 lm | 3,000 K | 151.90 |
| 41475423 | matt stainl. steel | 680 lm | 3,000 K | 151.90 |

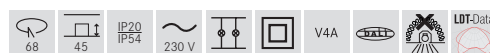

IP54 when installed in closed ceilings
This item is subject to discount group 1.

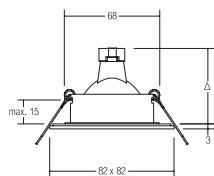

ITANSA-S recessed downlight, V4A, IP54, GX5.3

NEW

Lamp: for LED retrofit lamp, lamp holder: GX5,3, power: max. 35 W, material: V4A stainless steel / aluminium / glass

| Article no. | Colour | Price in € |
|-------------|-----------------------|------------|
| 26005070 | white matt | 74.30 |
| 26005080 | NEW matt black | 74.30 |
| 26005220 | matt stainl. steel | 74.30 |



IP54 when installed in closed ceilings
This item is subject to discount group 1.

ITANSA-S recessed downlight, V4A, IP54, GU10

NEW

Includes bracket with GU10 lamp holder for standard-compliant strain relief.

Lamp: for LED retrofit lamp, lamp holder: GU10, power: max. 35 W, material: V4A stainless steel / aluminium / glass

| Article no. | Colour | Price in € |
|-------------|-----------------------|------------|
| 36005070 | white matt | 84.90 |
| 36005080 | NEW matt black | 84.90 |
| 36005220 | matt stainl. steel | 84.90 |

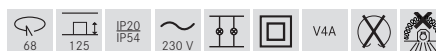

IP54 when installed in closed ceilings
This item is subject to discount group 1.

ITANSA-S LED recessed downlight set BB16, V4A, IP54, switchable

NEW

Set includes converter for 230 V mains supply, switchable, converter dimensions: L 68 x W 35 x H 21 mm

Lamp: LED, colour rendering: CRI > 80, power: 6 W, beam angle: 38°, material: V4A stainless steel / aluminium / glass / plastic

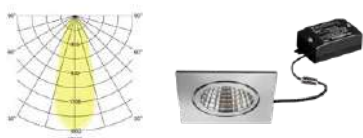

| Article no. | Colour | Lumin. flux | Colour temp. | Price in € |
|-------------|-----------------------|-------------|--------------|------------|
| 38376073 | white matt | 680 lm | 3,000 K | 105.90 |
| 38376083 | NEW matt black | 680 lm | 3,000 K | 105.90 |
| 38376423 | matt stainl. steel | 680 lm | 3,000 K | 105.90 |

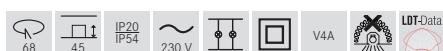

IP54 when installed in closed ceilings
This item is subject to discount group 1.

ITANSA-S LED recessed downlight set BB16, V4A, IP54, trailing-edge phase dimmable NEW

Set includes converter for 230 V mains supply, trailing-edge phase dimmable, converter dimensions: L 110 x W 50 x H 19 mm

Lamp: LED, colour rendering: CRI > 80, power: 6 W, beam angle: 38°, material: V4A stainless steel / aluminium / glass / plastic

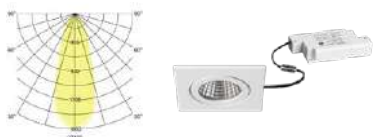

| Article no. | Colour | Lumin. flux | Colour temp. | Price in € |
|-------------|---|-------------|--------------|------------|
| 39376073 | white matt | 680 lm | 3,000 K | 110.90 |
| 39376083 | NEW matt black | 680 lm | 3,000 K | 110.90 |
| 39376423 | matt stainl. steel | 680 lm | 3,000 K | 110.90 |

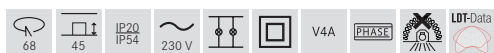

IP54 when installed in closed ceilings
This item is subject to discount group 1.

ITANSA-S LED recessed downlight set BB16, V4A, IP54, trailing-edge phase dimmable, with connection box NEW

Set includes converter for 230 V mains supply, trailing-edge phase dimmable, converter dimensions: L 110 x W 50 x H 19 mm

Lamp: LED, colour rendering: CRI > 80, power: 6 W, beam angle: 38°, material: V4A stainless steel / aluminium / glass / plastic, includes 3-pole connection box

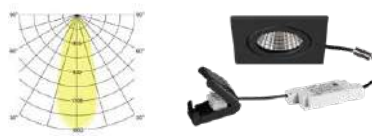

| Article no. | Colour | Lumin. flux | Colour temp. | Price in € |
|-------------|---|-------------|--------------|------------|
| 39476073 | white matt | 680 lm | 3,000 K | 112.90 |
| 39476083 | NEW matt black | 680 lm | 3,000 K | 112.90 |
| 39476423 | matt stainl. steel | 680 lm | 3,000 K | 112.90 |

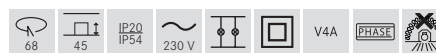

IP54 when installed in closed ceilings
This item is subject to discount group 1.

ITANSA-S LED recessed downlight set BB16, V4A, IP54 trailing-edge phase dimmable (round converter) NEW

Set includes round converter for 230 V mains supply, trailing-edge phase dimmable, converter dimensions: D 51 x H 24 mm

Lamp: LED, colour rendering: CRI > 80, power: 6 W, beam angle: 38°, material: V4A stainless steel / aluminium / glass / plastic

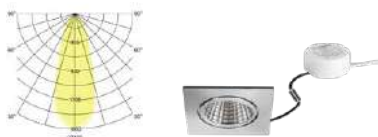

| Article no. | Colour | Lumin. flux | Colour temp. | Price in € |
|-------------|---|-------------|--------------|------------|
| 40376073 | white matt | 680 lm | 3,000 K | 117.90 |
| 40376083 | NEW matt black | 680 lm | 3,000 K | 117.90 |
| 40376423 | matt stainl. steel | 680 lm | 3,000 K | 117.90 |

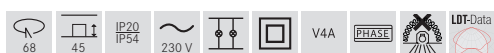

IP54 when installed in closed ceilings
This item is subject to discount group 1.

ITANSA-S LED recessed downlight set BB16, V4A, IP54, DALI dimmable, with connection box NEW

Set includes converter for 230 V mains supply, DALI-2 dimmable, converter dimensions: L 130 x W 42 x H 22 mm

Lamp: LED, colour rendering: CRI > 80, power: 6 W, beam angle: 38°, material: V4A stainless steel / aluminium / glass / plastic, includes 5-pole connection box

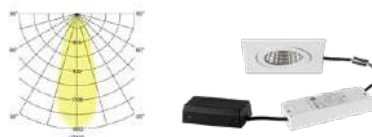

| Article no. | Colour | Lumin. flux | Colour temp. | Price in € |
|-------------|---|-------------|--------------|------------|
| 41476073 | white matt | 680 lm | 3,000 K | 154.90 |
| 41476083 | NEW matt black | 680 lm | 3,000 K | 154.90 |
| 41476423 | matt stainl. steel | 680 lm | 3,000 K | 154.90 |

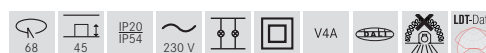

IP54 when installed in closed ceilings
This item is subject to discount group 1.

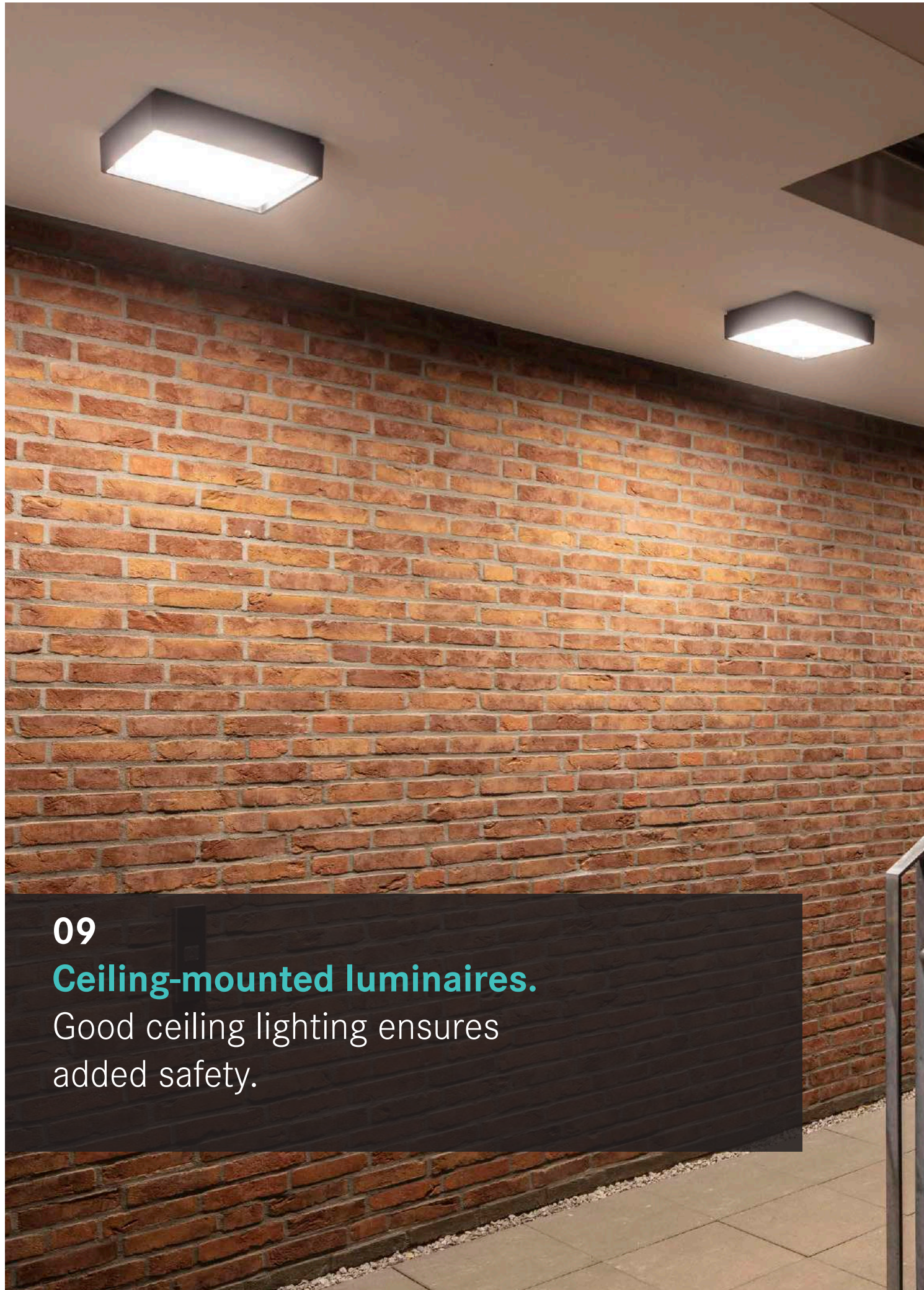

09

Ceiling-mounted luminaires.

Good ceiling lighting ensures added safety.





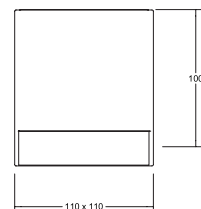
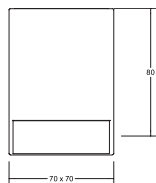

BLOKK LED ceiling-mounted luminaire, IP65, switchable

Lamp: LED, colour rendering: CRI > 80, power: 10 W, beam angle: 34°, material: aluminium / glass, includes converter for connection to 230 V mains supply, switchable

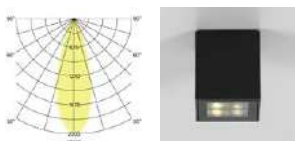

| Article no. | Colour | Lumin. flux | Colour temp. | Price in € |
|-------------|-------------------|-------------|--------------|------------|
| 60115103 | textured graphite | 635 lm | 3,000 K | 239.00 |



This item is subject to discount group 1.

Product family BLOKK



BLOKK surface-mounted spotlight

Article no.: 60111103

see page 403

BLOKK LED ceiling-mounted luminaire, IP65, switchable

Lamp: LED, colour rendering: CRI > 80, power: 22 W, beam angle: 32°, material: aluminium / glass, includes converter for connection to 230 V mains supply, switchable

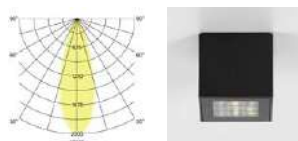

| Article no. | Colour | Lumin. flux | Colour temp. | Price in € |
|-------------|-------------------|-------------|--------------|------------|
| 60116103 | textured graphite | 1,600 lm | 3,000 K | 389.90 |



This item is subject to discount group 1.



BLOKK surface-mounted spotlight

Article no.: 60112103





see page 403



COOQUEE ceiling-mounted luminaire, IP65

Lamp: for LED retrofit lamp, lamp holder: E27,
power: max. 8 W, material: aluminium / glass / plastic.
Lamp not included in scope of supply.

| Article no. | Colour | Price in € |
|-------------|----------------|------------|
| 60141180 | textured black | 129.90 |





Accessories: replacement glass 81070000
(with silicone seal)

This item is subject to discount group 1.

Product family COOQUEE



COOQUEE wall-mounted luminaire

Article no.: 60140180

see page 363



COOQUEE bollard luminaire

Article no.: 60070180

see page 424





BARTIE LED ceiling & wall-mounted luminaire, IP54, switchable

Lamp: LED, colour rendering: CRI > 80, power: 14 W, beam angle: 110°, material: aluminium / acrylic, includes converter for connection to 230 V mains supply, switchable

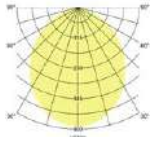

| Article no. | Colour | Luminous flux | Colour temp. | Price in € |
|-------------|----------------|---------------|--------------|------------|
| 60107183 | textured black | 1,210 lm | 3,000 K | 219.90 |

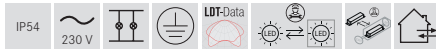

This item is subject to discount group 1.



BARTIE LED ceiling & wall-mounted luminaire, IP54, switchable

Lamp: LED, colour rendering: CRI > 80, power: 14 W, beam angle: 110°, material: aluminium / acrylic, includes converter for connection to 230 V mains supply, switchable

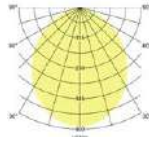

| Article no. | Colour | Luminous flux | Colour temp. | Price in € |
|-------------|----------------|---------------|--------------|------------|
| 60108183 | textured black | 1,230 lm | 3,000 K | 229.90 |



This item is subject to discount group 1.

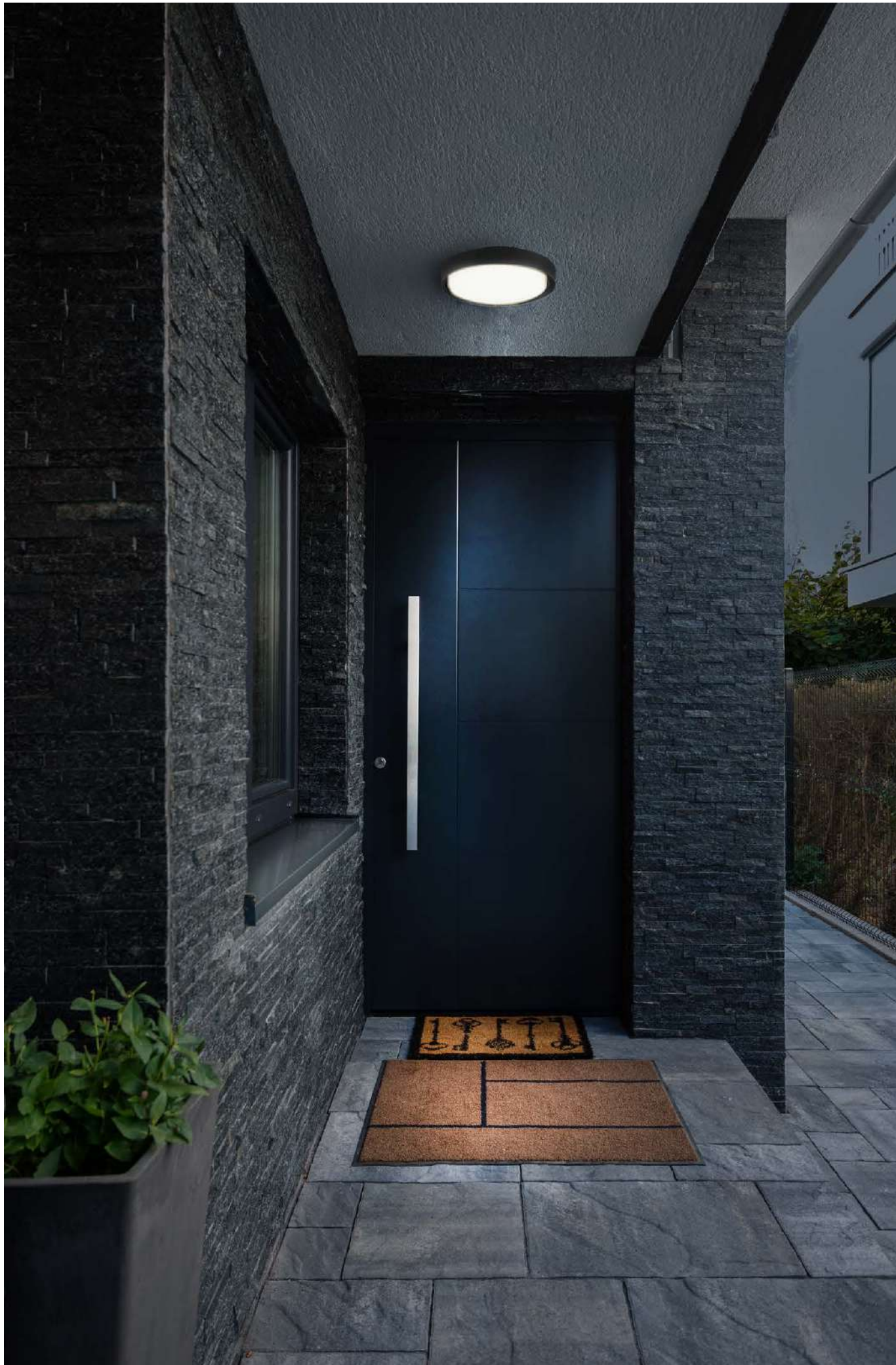

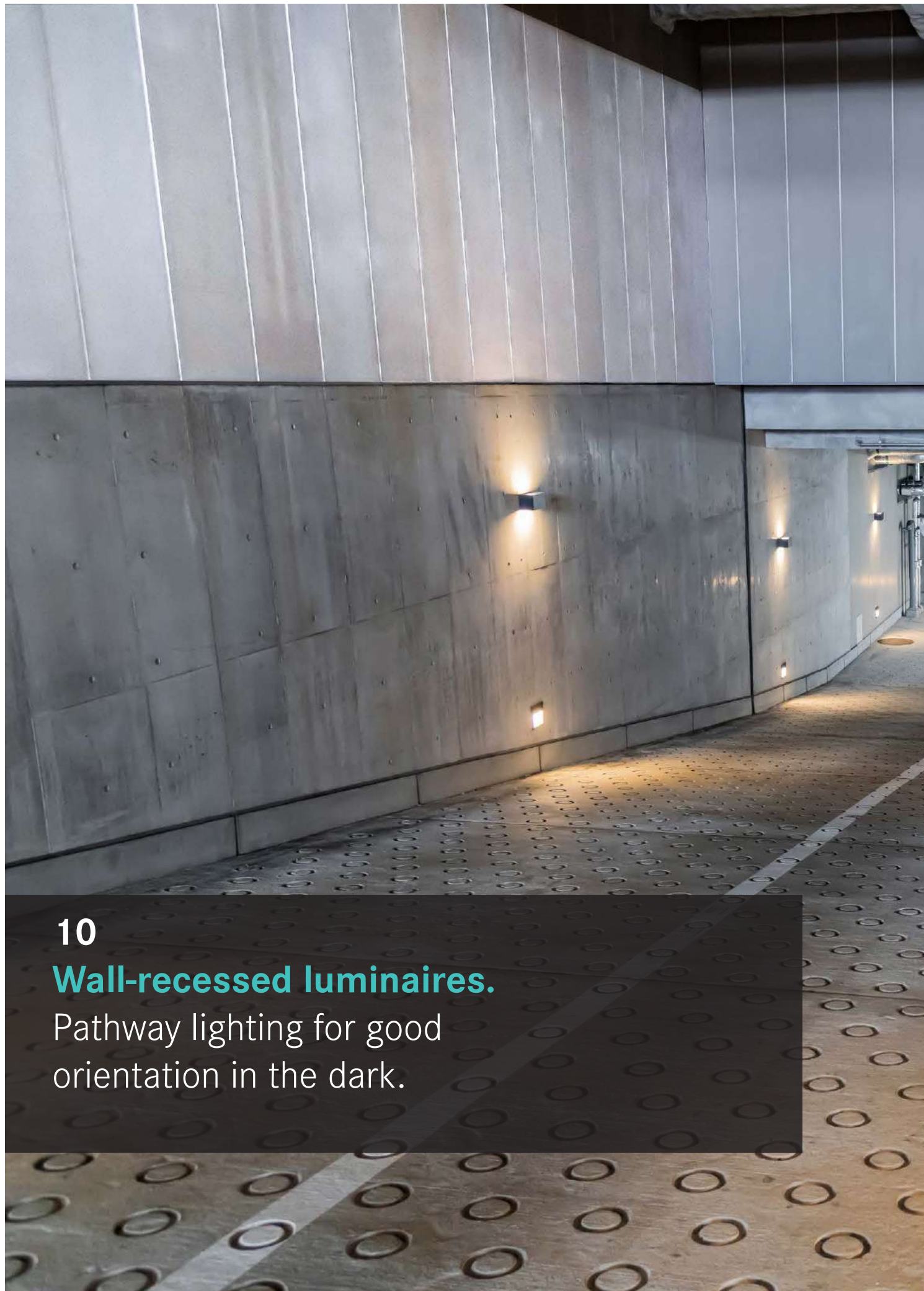

10

Wall-recessed luminaires.

Pathway lighting for good orientation in the dark.



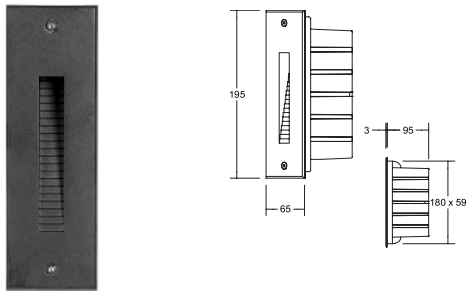

CILIMUS LED wall-recessed luminaire, IP65, switchable

Lamp: LED, colour rendering: CRI > 80, power: 2 W, material: aluminium / plastic

Scope of supply: includes converter for connection to 230 V mains supply, switchable and wall installation housing



| Article no. | Colour | Luminous flux | Colour temp. | Price in € |
|-------------|----------------|---------------|--------------|------------|
| 60210183 | textured black | 100 lm | 3,000 K | 169.90 |

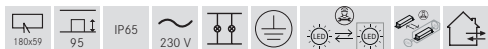

This item is subject to discount group 1.

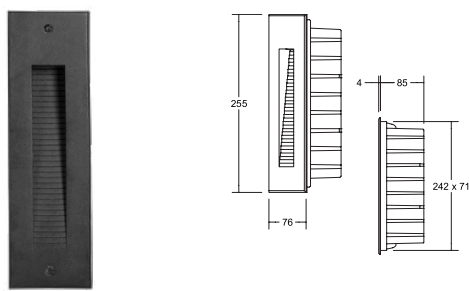

CILIMUS LED wall-recessed luminaire, IP65, switchable

Lamp: LED, colour rendering: CRI > 80, power: 4 W, material: aluminium / plastic

Scope of supply: includes converter for connection to 230 V mains supply, switchable and wall installation housing

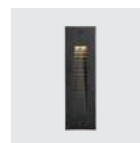

| Article no. | Colour | Luminous flux | Colour temp. | Price in € |
|-------------|----------------|---------------|--------------|------------|
| 60211183 | textured black | 180 lm | 3,000 K | 229.90 |

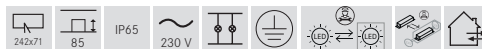

This item is subject to discount group 1.



Eiswiese, Göttingen



COORARA LED wall-recessed luminaire, IP65, switchable

Lamp: LED, colour rendering: CRI > 80, power: 6 W, material: aluminium / plastic

Scope of supply: includes converter for connection to 230 V mains supply, switchable and wall installation housing

| Article no. | Colour | Luminous flux | Colour temp. | Price in € |
|-------------|----------------|---------------|--------------|------------|
| 60205183 | textured black | 230 lm | 3,000 K | 244.90 |



This item is subject to discount group 1.

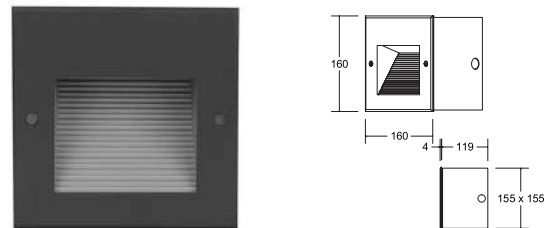

CARDUI LED wall-recessed luminaire, IP65, switchable

Lamp: LED, colour rendering: CRI > 80, power: 2 W, material: aluminium / plastic

Scope of supply: includes converter for connection to 230 V mains supply, switchable and wall installation housing

| Article no. | Colour | Luminous flux | Colour temp. | Price in € |
|-------------|----------------|---------------|--------------|------------|
| 60208183 | textured black | 100 lm | 3,000 K | 219.90 |

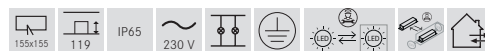

This item is subject to discount group 1.

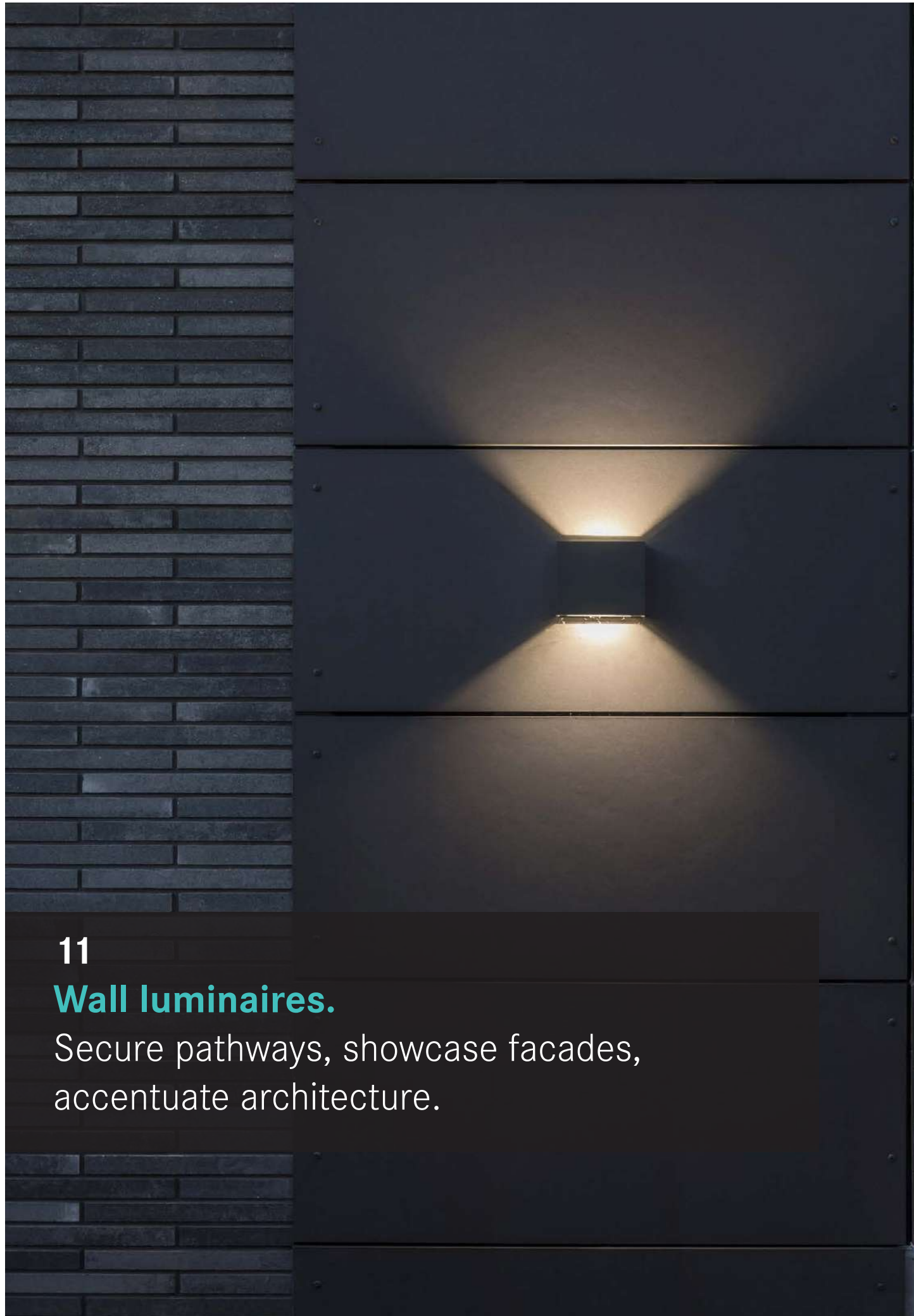

11

Wall luminaires.

Secure pathways, showcase facades,
accentuate architecture.

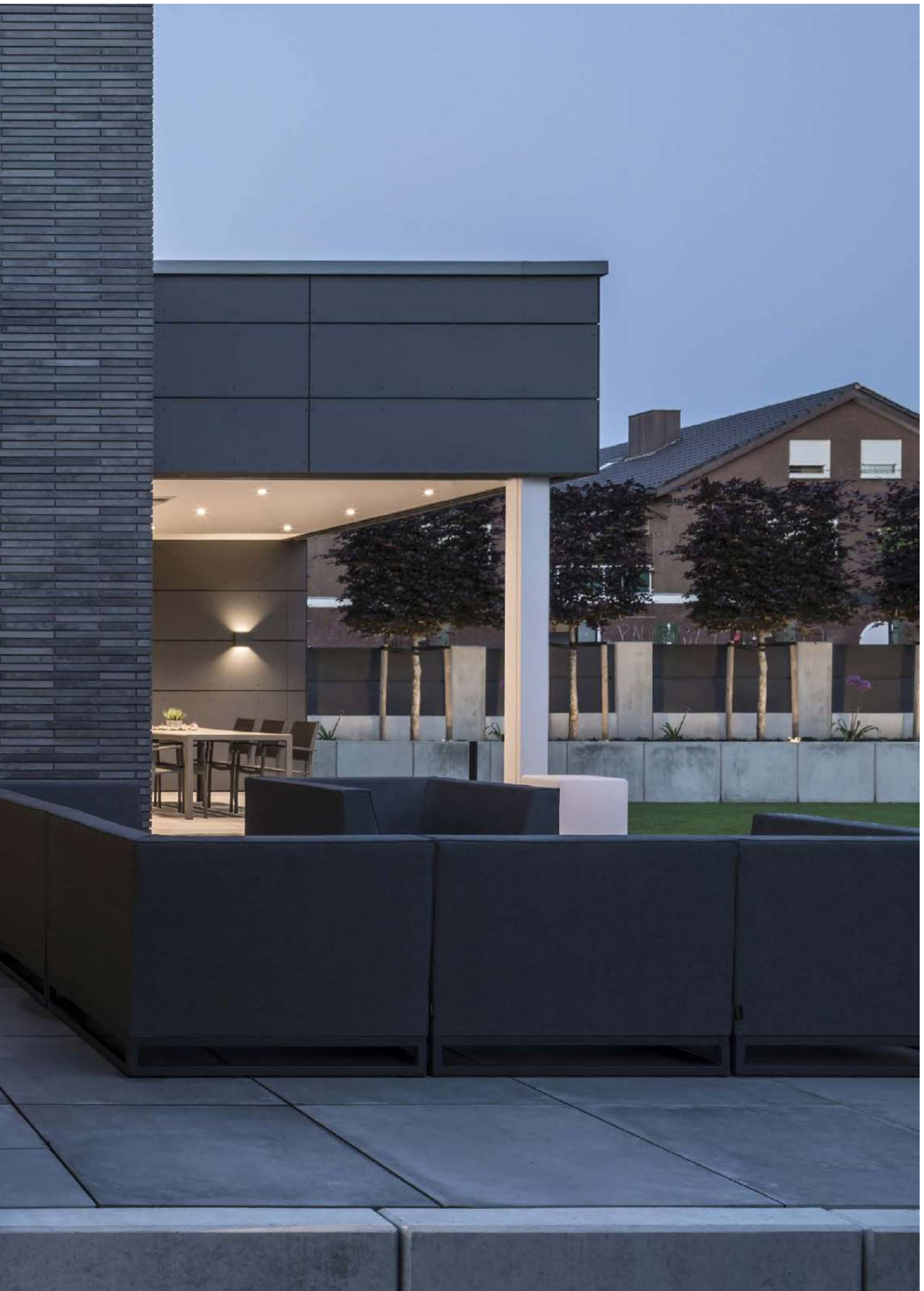

STICK.

Consistent design
for outdoor areas.

Switchable colour temperature
3,000 K or 4,000 K.

Interchangeable luminaire
head for consistent design
with wall and
bollard luminaires.



IP65
IK08

IP65 has complete protection against accidental contact. Dust cannot penetrate and it is protected against jets of water in any direction.

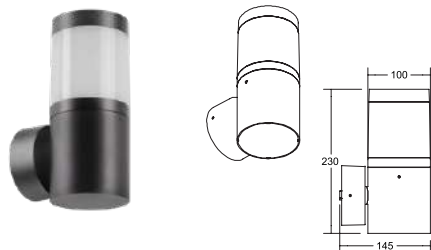

STICK LED wall-mounted luminaire, IP65, switchable

NEW

Lamp: LED, colour rendering: CRI > 80, power: 8 W, beam angle: 120°, material: aluminium / plastic, includes converter for connection to 230 V mains supply, switchable

Service life:

L70/B50, > 50,000 hrs. (ta: +25 °C)

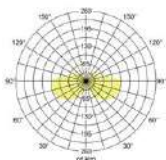

| Article no. | Colour | Lumin. flux | Colour temp. | Price in € |
|-------------|--------------------|-------------|-------------------|------------|
| 10039183 | NEW textured black | 530 lm | 3,000 K / 4,000 K | 169.90 |



This item is subject to discount group 1.



STICK bollard luminaires
see page 407

EYE.

Impact-resistant with adjustable colour temperature.



Switchable colour temperature
3,000 K, 4,000 K or 5,700 K

NEW

now also
protected
against
seawater



IP65 IK08/10

IP65 has complete protection against accidental contact. Dust cannot penetrate and it is protected against jets of water in any direction.

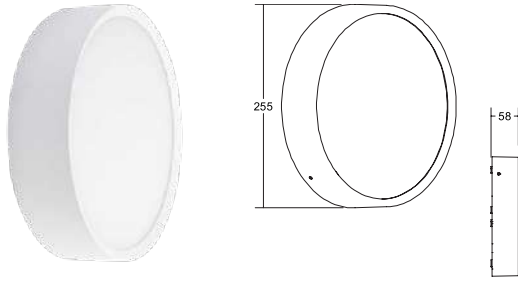

EYE LED wall-mounted luminaire, IP65, switchable

NEW

The colour temperatures can be adjusted on site from 3,000 K to 4,000 K or 5,700 K.

Lamp: LED, colour rendering: CRI > 80, power: 12 W, beam angle: 110°, material: aluminium / plastic, includes converter for connection to 230 V mains supply, switchable

Service life:

L70/B50, > 50,000 hrs. (ta: +25 °C)

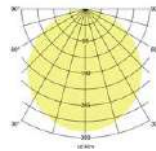

| Article no. | Colour | Lumin. flux | Price in € |
|-----------------------|----------------|-------------|------------|
| 10036173 | textured white | 1,000 lm | 139.90 |
| 10036183 | textured black | 1,000 lm | 139.90 |
| 10036173MC NEW | textured white | 1,000 lm | 159.90 |
| 10036183MC NEW | textured black | 1,000 lm | 159.90 |



Luminous flux for colour temperature 4,000 K. These items are subject to discount group 1.

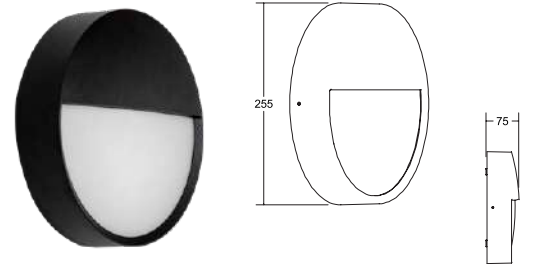

EYE LED wall-mounted luminaire, IP65, switchable

NEW

The colour temperatures can be adjusted on site from 3,000 K to 4,000 K or 5,700 K.

Lamp: LED, colour rendering: CRI > 80, power: 12 W, beam angle: 110°, material: aluminium / plastic, includes converter for connection to 230 V mains supply, switchable

Service life:

L70/B50, > 50,000 hrs. (ta: +25 °C)

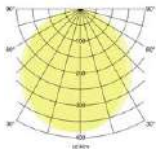

| Article no. | Colour | Lumin. flux | Price in € |
|-----------------------|----------------|-------------|------------|
| 10037173 | textured white | 880 lm | 149.90 |
| 10037183 | textured black | 880 lm | 149.90 |
| 10037173MC NEW | textured white | 880 lm | 189.90 |
| 10037183MC NEW | textured black | 880 lm | 189.90 |



Luminous flux for colour temperature 4,000 K. These items are subject to discount group 1.

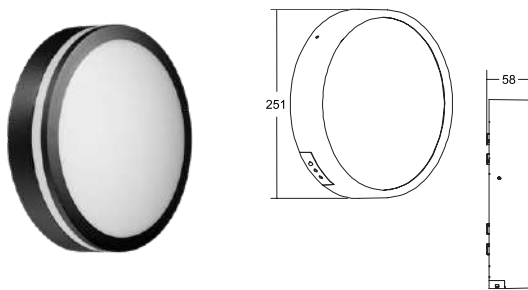

EYE LED wall-mounted luminaire, IP65, switchable

The colour temperatures can be adjusted on site from 3,000 K to 4,000 K or 5,700 K.

Lamp: LED, colour rendering: CRI > 80, power: 18 W, beam angle: 120°, material: aluminium / plastic, includes converter for connection to 230 V mains supply, switchable

Service life:

L70/B50, > 50,000 hrs. (ta: +25 °C)

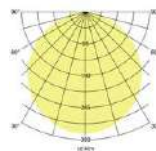

| Article no. | Colour | Lumin. flux | Price in € |
|-------------|----------------|-------------|------------|
| 10136173 | textured white | 1,530 lm | 169.90 |
| 10136183 | textured black | 1,530 lm | 169.90 |



Luminous flux for colour temperature 4,000 K. These items are subject to discount group 1.

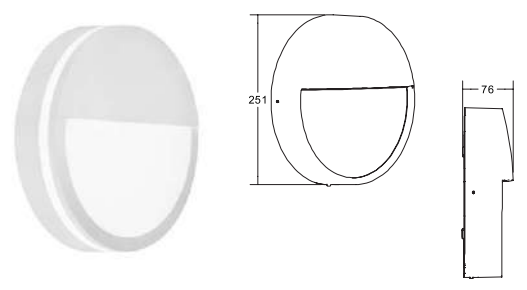

EYE LED wall-mounted luminaire, IP65, switchable

The colour temperatures can be adjusted on site from 3,000 K to 4,000 K or 5,700 K.

Lamp: LED, colour rendering: CRI > 80, power: 18 W, beam angle: 120°, material: aluminium / plastic, includes converter for connection to 230 V mains supply, switchable

Service life:

L70/B50, > 50,000 hrs. (ta: +25 °C)

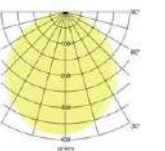

| Article no. | Colour | Lumin. flux | Price in € |
|-------------|----------------|-------------|------------|
| 10137173 | textured white | 900 lm | 189.90 |
| 10137183 | textured black | 900 lm | 189.90 |



Luminous flux for colour temperature 4,000 K. These items are subject to discount group 1.

YLIP.

LED wall-mounted luminaires.

Variable colour temperature for the facade.

Switchable colour temperature
3,000 K, 4,000 K or 5,700 K



IP65
IK06

IP65 has complete protection against accidental contact. Dust cannot penetrate and it is protected against jets of water in any direction.

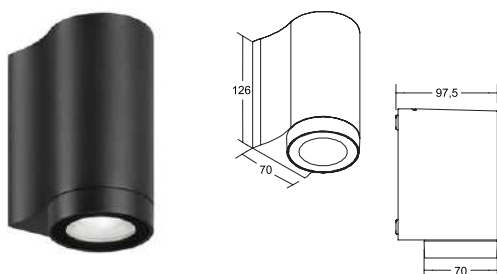

YLIP LED wall-mounted luminaire, IP65, direct, switchable

The colour temperature can be adjusted on site from 3,000 K to 4,000 K or 5,700 K.

Lamp: LED, colour rendering: CRI > 80, power: 8 W, beam angle: 120°, material: aluminium / glass, includes converter for connection to 230 V mains supply, switchable

Service life:

L80/B50, > 54,000 hrs. (ta: +25 °C)

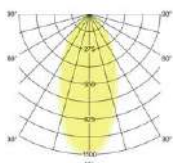

| Article no. | Colour | Lumin. flux | Price in € |
|-------------|----------------|-------------|------------|
| 10130183 | textured black | 800 lm | 129.90 |



This item is subject to discount group 1.

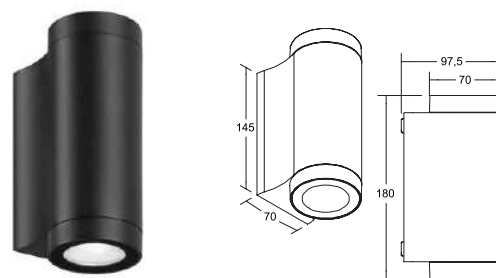

YLIP LED wall-mounted luminaire, IP65, direct / indirect, switchable

The colour temperature can be adjusted on site from 3,000 K to 4,000 K or 5,700 K.

Lamp: LED, colour rendering: CRI > 80, power: 15 W, beam angle: 120°, material: aluminium / glass, includes converter for connection to 230 V mains supply, switchable

Service life:

L80/B50, > 54,000 hrs. (ta: +25 °C)

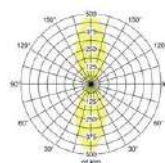

| Article no. | Colour | Lumin. flux | Price in € |
|-------------|----------------|-------------|------------|
| 10131183 | textured black | 1,500 lm | 159.90 |



This item is subject to discount group 1.

MAKIRA.

Quick replacement of the shades
for customised concepts.





MAKIRA LED ceiling & wall-mounted luminaire, IP65, trailing-edge phase dimmable

NEW

The light colour can be adjusted on site from 2,700 K to 3,000 K or 4,000 K.

Lamp: LED, colour rendering: CRI > 80, power: 18 W, beam angle: 120°, material: plastic, includes converter for 230 V mains supply, trailing-edge phase dimmable

| Article no. | Colour | Lumin. flux | Price in € |
|-------------|---------------------------|-------------|------------|
| 10028183 | NEW textured black | 1,700 lm | 54.90 |



MAKIRA LED ceiling & wall-mounted luminaire, IP65, trailing-edge phase dimmable

NEW

The light colour can be adjusted on site from 2,700 K to 3,000 K or 4,000 K.

Lamp: LED colour rendering: CRI > 80, power: 30 W, beam angle: 120°, material: plastic, includes converter for 230 V mains supply, trailing-edge phase dimmable

| Article no. | Colour | Lumin. flux | Price in € |
|-------------|---------------------------|-------------|------------|
| 10029183 | NEW textured black | 2,900 lm | 79.90 |



Accessories for MAKIRA

Optional accessories:
front rings (see below) for modifying the housing colour



| Article no. | Description | Colour | Price in € |
|-------------|------------------------------------|-------------|------------|
| 81128090 | NEW Front ring for 10028... | matt gold | 5.90 |
| 81128170 | NEW Front ring for 10028... | matt white | 5.90 |
| 81128690 | NEW Front ring for 10028... | matt silver | 5.90 |
| 81129090 | NEW Front ring for 10029... | matt gold | 7.90 |
| 81129170 | NEW Front ring for 10029... | matt white | 7.90 |
| 81129690 | NEW Front ring for 10029... | matt silver | 7.90 |



LIFOU.

Modern light image for your building.

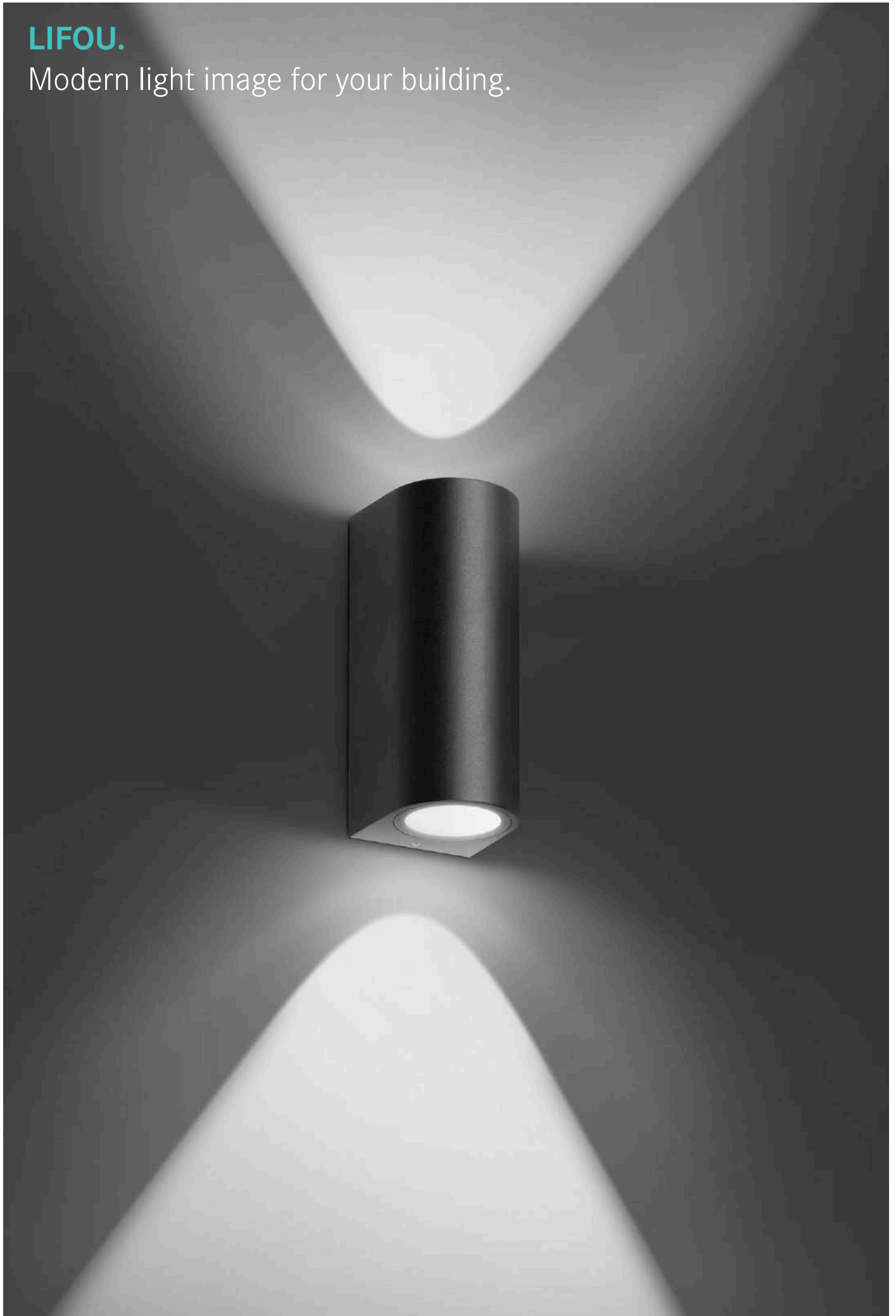

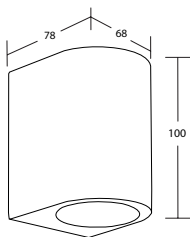

LIFOU Wall-mounted luminaire, GU10, IP65

NEW

Lamp: for LED retrofit lamp, lamp holder: GU10, power: max. 10 W, material: aluminium / glass

| Article no. | Colour | Price in € |
|-------------|--------------------|------------|
| 65331180 | NEW textured black | 69.90 |



These items are subject to discount group 1.

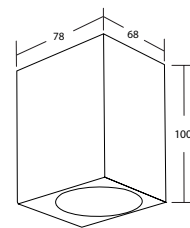

LIFOU Wall-mounted luminaire, GU10, IP65

NEW

Lamp: for LED retrofit lamp, lamp holder: GU10, power: max. 10 W, material: aluminium / glass

| Article no. | Colour | Price in € |
|-------------|--------------------|------------|
| 65341180 | NEW textured black | 69.90 |

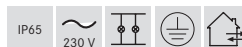

These items are subject to discount group 1.

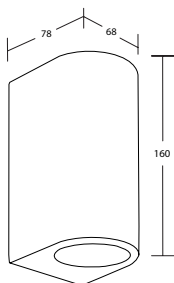

LIFOU Wall-mounted luminaire, GU10, IP65, direct / indirect

NEW

Lamp: for LED retrofit lamp, lamp holder: GU10, power: max. 2 x 10 W, material: aluminium / glass

| Article no. | Colour | Price in € |
|-------------|--------------------|------------|
| 65332180 | NEW textured black | 79.90 |

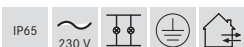

These items are subject to discount group 1.

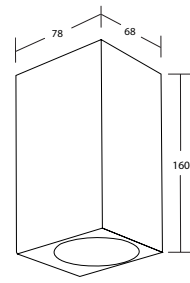

LIFOU Wall-mounted luminaire, GU10, IP65, direct / indirect

NEW

Lamp: for LED retrofit lamp, lamp holder: GU10, power: max. 2 x 10 W, material: aluminium / glass

| Article no. | Colour | Price in € |
|-------------|--------------------|------------|
| 65342180 | NEW textured black | 79.90 |

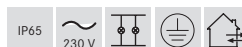

These items are subject to discount group 1.

LOMBOK.

Simple and discreet.



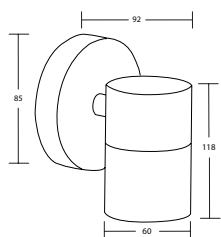

LOMBOK Wall-mounted luminaire, GU 10, IP44

NEW

Lamp: for LED retrofit lamp, lamp holder: GU10, power: max. 8 W, material: aluminium / glass

| Article no. | Colour | Price in € |
|-------------|-----------------------|------------|
| 65352100 | NEW textured graphite | 69.90 |

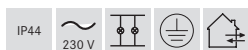

These items are subject to discount group 1.

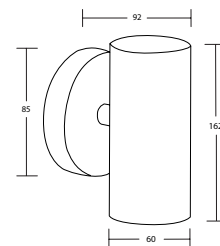

LOMBOK Wall-mounted luminaire, GU 10, IP44, direct/indirect

NEW

Lamp: for LED retrofit lamp, lamp holder: GU10, power: max. 2 x 8 W, material: aluminium / glass

| Article no. | Colour | Price in € |
|-------------|-----------------------|------------|
| 65353100 | NEW textured graphite | 74.90 |

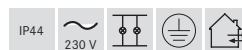

These items are subject to discount group 1.

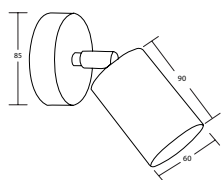

LOMBOK Wall-mounted luminaire, GU 10, IP44

NEW

Lamp: for LED retrofit lamp, lamp holder: GU10, power: max. 8 W, material: aluminium / glass

| Article no. | Colour | Price in € |
|-------------|-----------------------|------------|
| 65351100 | NEW textured graphite | 79.90 |

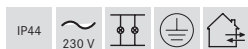

These items are subject to discount group 1.

LEVU.

**Rectilinear design
for façades and paths.**

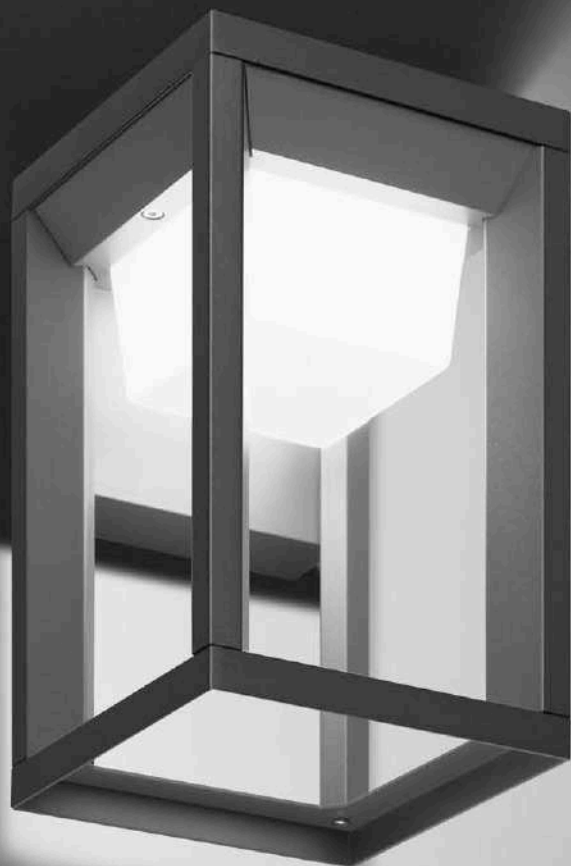

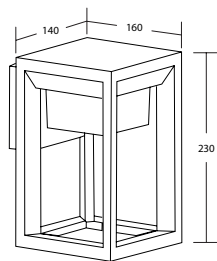

LEVU LED wall-mounted luminaire, IP54, switchable

NEW

Lamp: LED, colour rendering: CRI > 80, power: 6.6 W, beam angle: 120°, material: die-cast aluminium / plastic, includes converter for connection to 230 V mains supply, switchable

| Article no. | Colour | Lumin. flux | Colour temp. | Price in € |
|-------------|-----------------------|-------------|--------------|------------|
| 65381103 | NEW textured graphite | 420 lm | 3,000 K | 139.90 |



These items are subject to discount group 1.

LEVU bollard luminaires

see page 409



COATIS.

Modern lighting design
for outdoor areas.



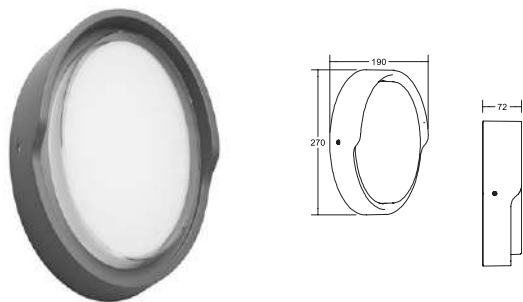

COATIS LED wall-mounted luminaire, IP65, switchable NEW

Lamp: LED, colour rendering: CRI > 80, power: 12 W, beam angle: 110°, material: aluminium, includes converter for connection to 230 V mains supply, switchable

| Article no. | Colour | Lumin. flux | Colour temp. | Price in € |
|-------------|---|-------------|--------------|------------|
| 10221103 | NEW textured graphite | 875 lm | 3,000 K | 139.90 |

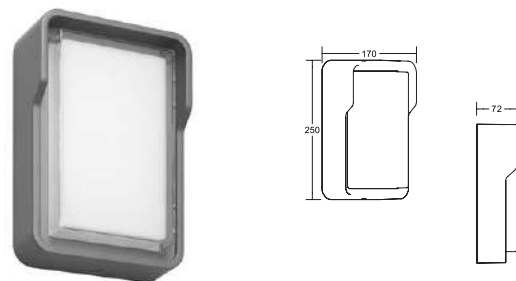

COATIS LED wall-mounted luminaire, IP65, switchable NEW

Lamp: LED, colour rendering: CRI > 80, power: 12 W, beam angle: 113°, material: aluminium, includes converter for connection to 230 V mains supply, switchable

| Article no. | Colour | Lumin. flux | Colour temp. | Price in € |
|-------------|---|-------------|--------------|------------|
| 10222103 | NEW textured graphite | 825 lm | 3,000 K | 139.90 |

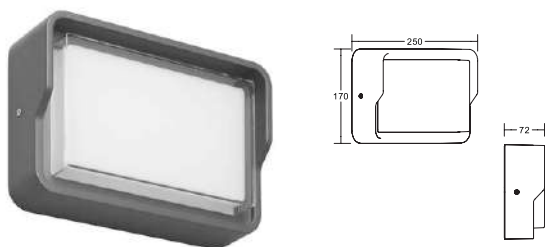

COATIS LED wall-mounted luminaire, IP65, switchable NEW

Lamp: LED, colour rendering: CRI > 80, power: 12 W, beam angle: 115°, material: aluminium, includes converter for connection to 230 V mains supply, switchable

| Article no. | Colour | Lumin. flux | Colour temp. | Price in € |
|-------------|---|-------------|--------------|------------|
| 10223103 | NEW textured graphite | 970 lm | 3,000 K | 139.90 |

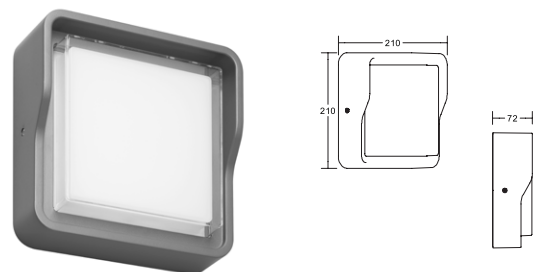

COATIS LED wall-mounted luminaire, IP65, switchable NEW

Lamp: LED, colour rendering: CRI > 80, power: 12 W, beam angle: 113°, material: aluminium, includes converter for connection to 230 V mains supply, switchable

| Article no. | Colour | Lumin. flux | Colour temp. | Price in € |
|-------------|---|-------------|--------------|------------|
| 10224103 | NEW textured graphite | 735 lm | 3,000 K | 139.90 |



MADURA.

Functional beauty for
paths and façades.

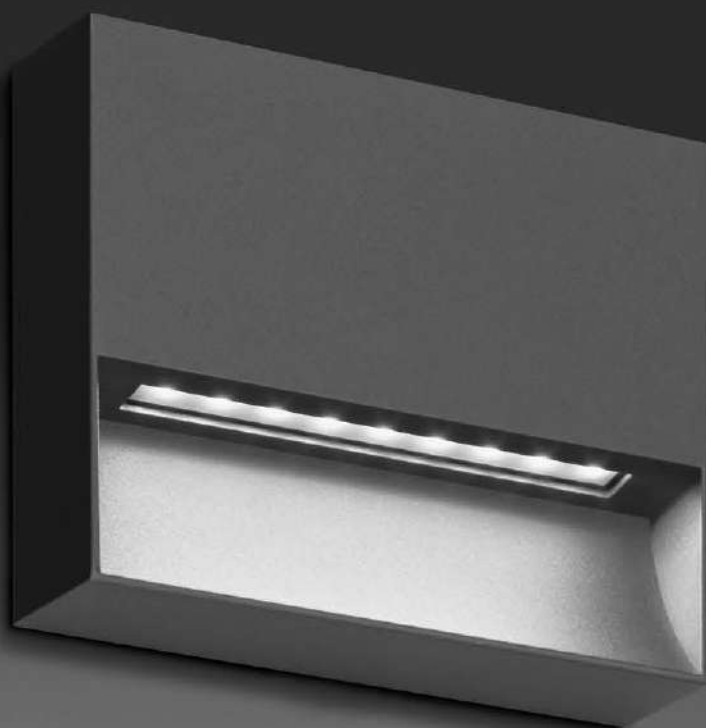

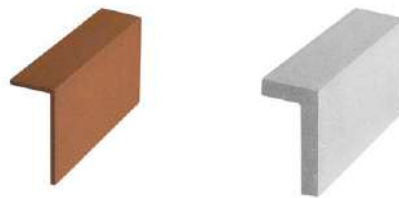
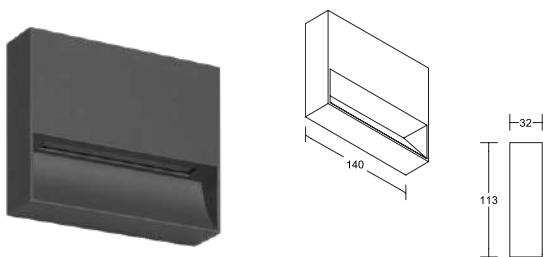

MADURA LED wall-mounted luminaire, IP65, switchable

NEW

The light colour can be adjusted on site from 2,700 K to 3,000 K.

Lamp: LED, version: without lamp holder, colour rendering: CRI > 80, power: 4.5 W, beam angle: 72°, material: aluminium, includes converter for connection to 230 V mains supply, switchable

MADURA Cover for MADURA wall-mounted luminaire 60119103

NEW

Optional accessories:

cover for modifying the luminaire, dimensions: L x W x H: 140 x 33 x 70 mm, material: aluminium or concrete

| Article no. | Colour | Luminous flux | Price in € |
|-------------|-----------------------|---------------|------------|
| 60119103 | NEW textured graphite | 102 lm | 169.90 |

| Article no. | Colour | Description | Price in € |
|-------------|--------------|--------------------|------------|
| 81401120 | NEW rust | Cover for 60119... | 29.90 |
| 81401730 | NEW concrete | Cover for 60119... | 39.90 |

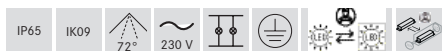

Luminous flux specification for light colour 3,000 K.



RICO.

Innovative design
for an extraordinary
appearance.

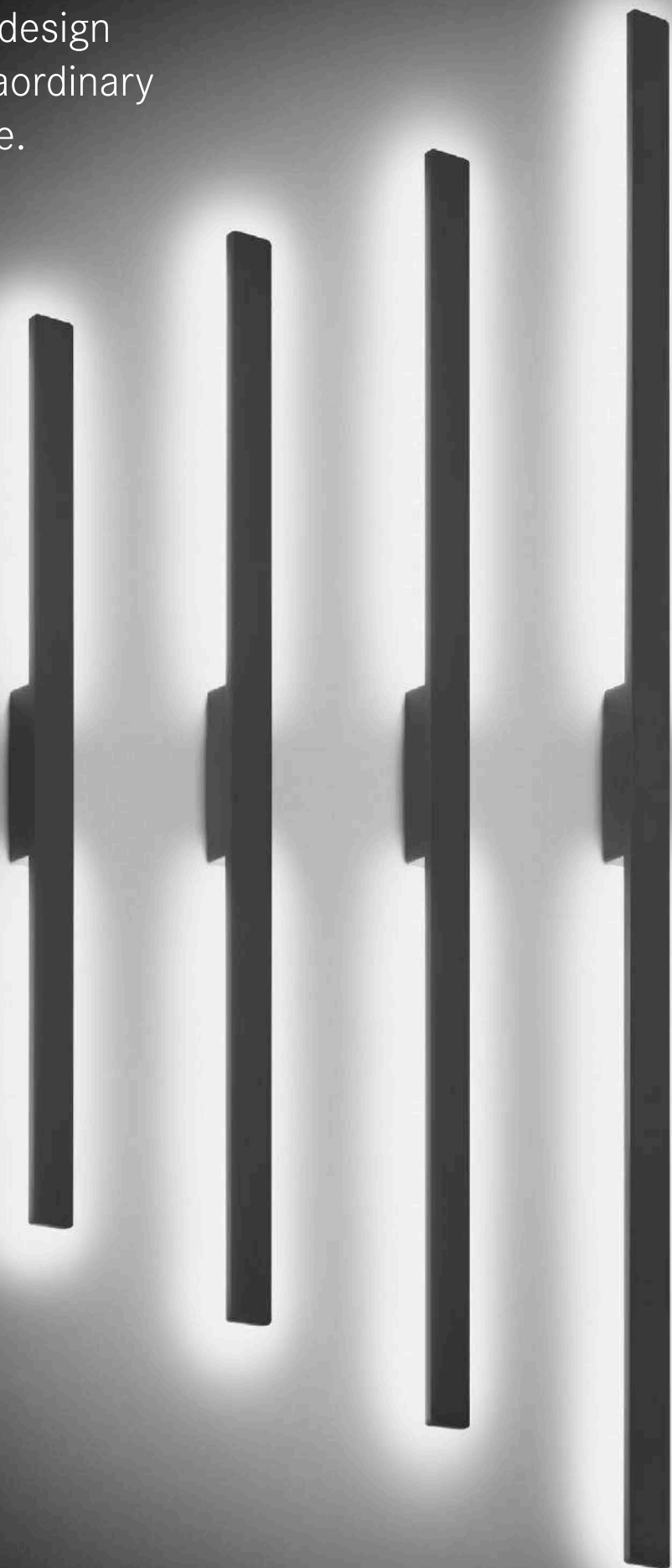

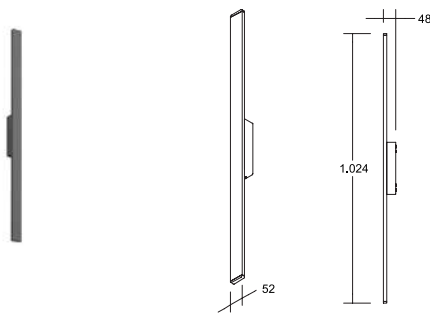

RICO LED wall-mounted luminaire, IP65, switchable

NEW

Indirect light emission.

Lamp: LED, version: without lamp holder, colour rendering: CRI > 90, power: 18 W, beam angle: 120°, material: aluminium / plastic, includes converter for connection to 230 V mains supply, switchable

| Article no. | Colour | Lumin. flux | Colour temp. | Price in € |
|-------------|-----------------------|-------------|--------------|------------|
| 60040103 | NEW textured graphite | 1,625 lm | 3,000 K | 189.90 |



These items are subject to discount group 1.

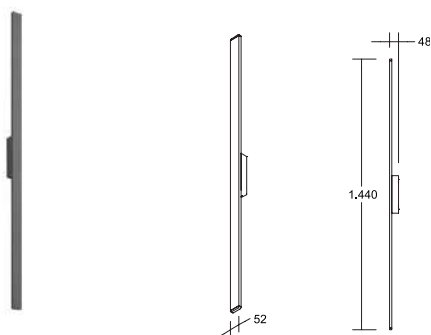

RICO LED wall-mounted luminaire, IP65, switchable

NEW

Indirect light emission.

Lamp: LED, version: without lamp holder, colour rendering: CRI > 90, power: 24 W, beam angle: 120°, material: aluminium / plastic, includes converter for connection to 230 V mains supply, switchable

| Article no. | Colour | Lumin. flux | Colour temp. | Price in € |
|-------------|-----------------------|-------------|--------------|------------|
| 60042103 | NEW textured graphite | 2,350 lm | 3,000 K | 229.90 |

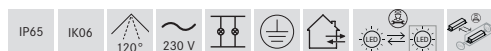

These items are subject to discount group 1.

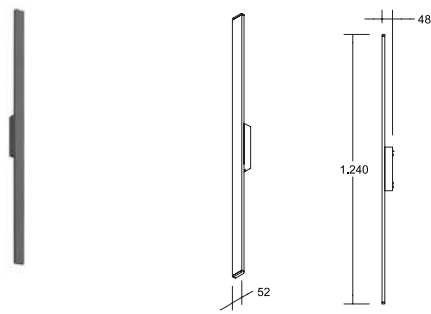

RICO LED wall-mounted luminaire, IP65, switchable

NEW

Indirect light emission.

Lamp: LED, version: without lamp holder, colour rendering: CRI > 90, power: 20 W, beam angle: 120°, material: aluminium / plastic, includes converter for connection to 230 V mains supply, switchable

| Article no. | Colour | Lumin. flux | Colour temp. | Price in € |
|-------------|-----------------------|-------------|--------------|------------|
| 60041103 | NEW textured graphite | 1,900 lm | 3,000 K | 209.90 |



These items are subject to discount group 1.

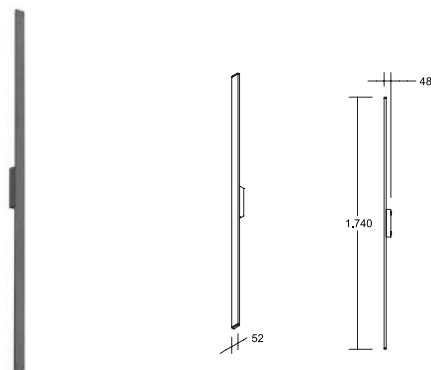

RICO LED wall-mounted luminaire, IP65, switchable

NEW

Indirect light emission.

Lamp: LED, version: without lamp holder, colour rendering: CRI > 90, power: 28 W, beam angle: 120°, material: aluminium / plastic, includes converter for connection to 230 V mains supply, switchable

| Article no. | Colour | Lumin. flux | Colour temp. | Price in € |
|-------------|-----------------------|-------------|--------------|------------|
| 60043103 | NEW textured graphite | 2,600 lm | 3,000 K | 249.90 |

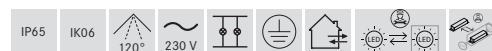

These items are subject to discount group 1.

EREBIA.

Striking shape
combined with
elegant light emission.

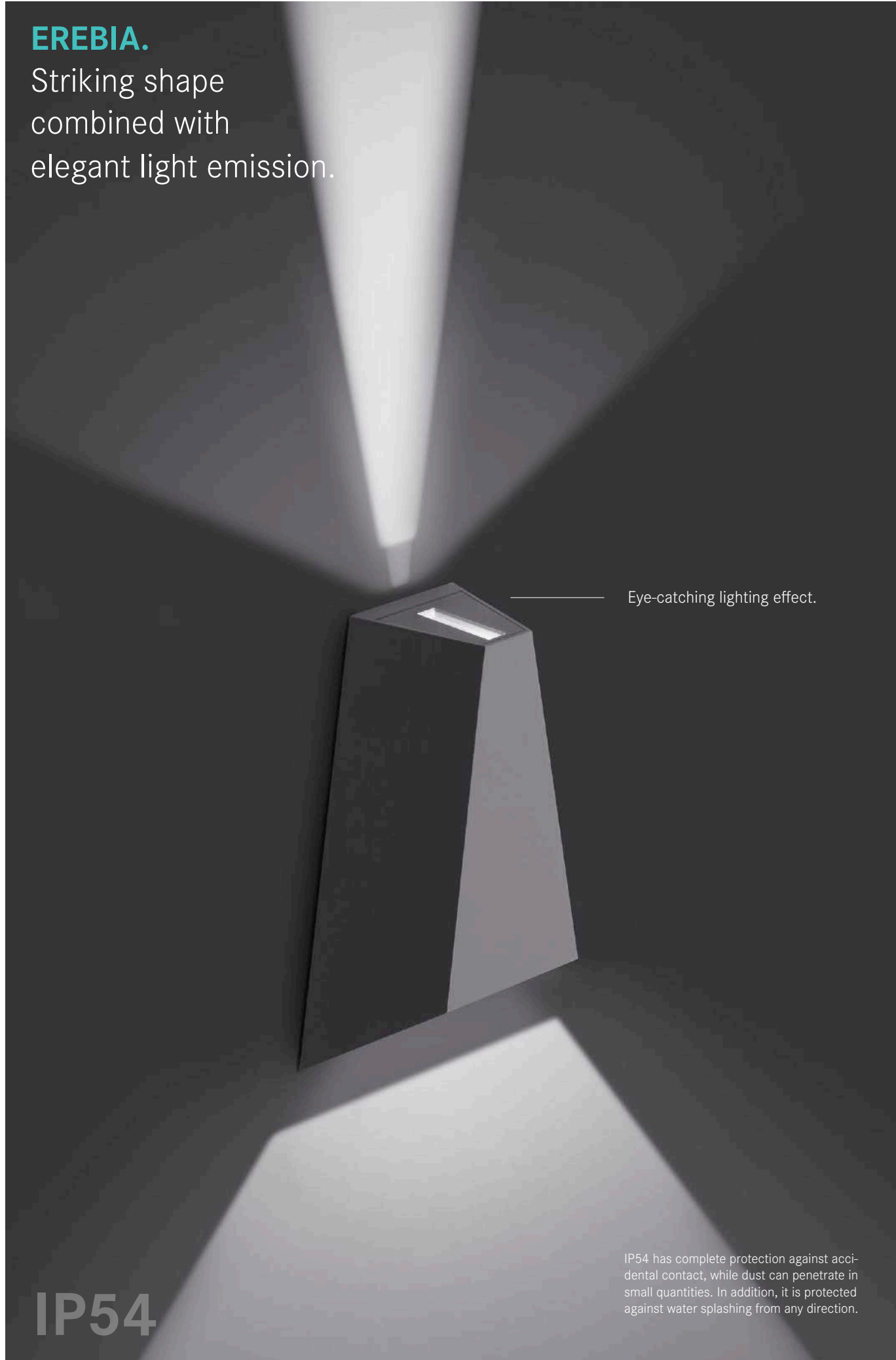

Eye-catching lighting effect.

IP54

IP54 has complete protection against accidental contact, while dust can penetrate in small quantities. In addition, it is protected against water splashing from any direction.

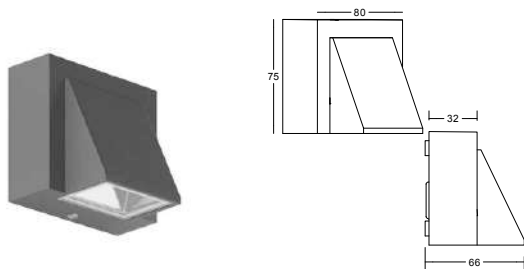

MEGERA LED wall-mounted luminaire, IP54, direct, switchable

Lamp: LED, colour rendering: CRI > 80, power: 1 W, material: aluminium / glass, includes converter for connection to 230 V mains supply, switchable



| Article no. | Colour | Lumin. flux | Colour temp. | Price in € |
|-------------|-------------------|-------------|--------------|------------|
| 65011103 | textured graphite | 72 lm | 3,000 K | 121.60 |



This item is subject to discount group 1.

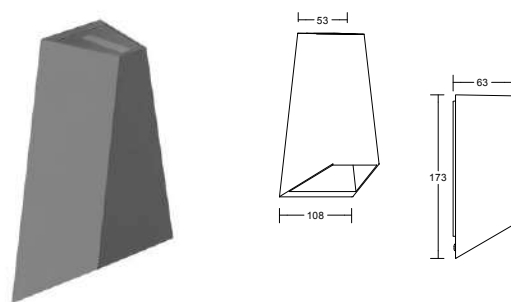

EREBIA LED wall-mounted luminaire, IP54, direct / indirect, switchable

Lamp: LED, colour rendering: CRI > 80, power: 6 W, material: aluminium / glass, includes converter for connection to 230 V mains supply, switchable



| Article no. | Colour | Lumin. flux | Colour temp. | Price in € |
|-------------|-------------------|-------------|--------------|------------|
| 65041103 | textured graphite | 90 lm | 3,000 K | 161.80 |



This item is subject to discount group 1.

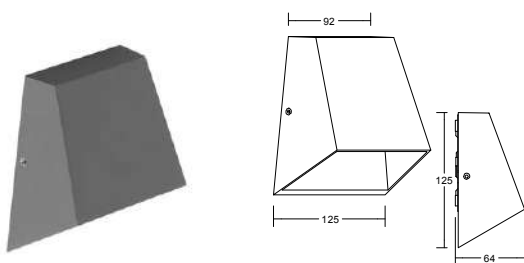

ALEXIS LED wall-mounted luminaire, IP54, direct, switchable

Lamp: LED, colour rendering: CRI > 80, power: 7 W, material: aluminium / polycarbonate, includes converter for connection to 230 V mains supply, switchable



| Article no. | Colour | Lumin. flux | Colour temp. | Price in € |
|-------------|-------------------|-------------|--------------|------------|
| 65021103 | textured graphite | 329 lm | 3,000 K | 163.00 |



This item is subject to discount group 1.

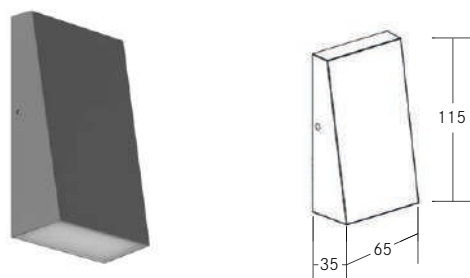

DAR LED wall-mounted luminaire, IP54, direct, switchable

Lamp: LED, colour rendering: CRI > 80, power: 3 W, material: aluminium / glass, includes converter for connection to 230 V mains supply, switchable



| Article no. | Colour | Lumin. flux | Colour temp. | Price in € |
|-------------|-------------------|-------------|--------------|------------|
| 65031103 | textured graphite | 165 lm | 3,000 K | 115.30 |



This item is subject to discount group 1.

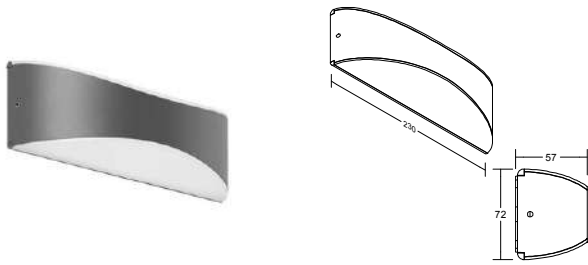

REMUS LED wall-mounted luminaire, IP65, direct / indirect, switchable

Lamp: LED, colour rendering: CRI > 80, power: 9.5 W, material: aluminium / polycarbonate, includes converter for connection to 230 V mains supply, switchable



| Article no. | Colour | Lumin. flux | Colour temp. | Price in € |
|-------------|-------------------|-------------|--------------|------------|
| 65061103 | textured graphite | 1,050 lm | 3,000 K | 116.80 |



This item is subject to discount group 1.

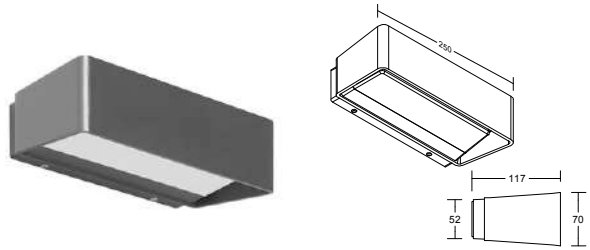

TULLIA LED wall-mounted luminaire, IP65, direct / indirect, switchable

Lamp: LED, colour rendering: CRI > 80, power: 11 W, material: aluminium / polycarbonate, includes converter for connection to 230 V mains supply, switchable



| Article no. | Colour | Lumin. flux | Colour temp. | Price in € |
|-------------|-------------------|-------------|--------------|------------|
| 65051103 | textured graphite | 1,000 lm | 3,000 K | 147.40 |



This item is subject to discount group 1.

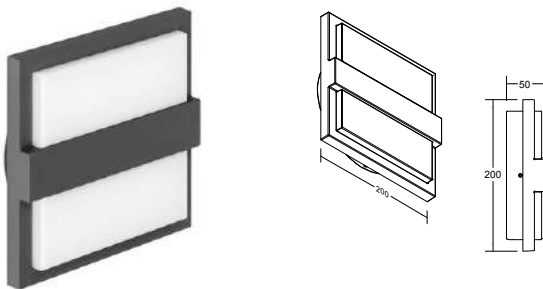

NAGAI LED wall-mounted luminaire, IP65, direct, switchable

Lamp: LED, colour rendering: CRI > 80, power: 8.6 W, material: aluminium / polycarbonate, includes converter for connection to 230 V mains supply, switchable



| Article no. | Colour | Lumin. flux | Colour temp. | Price in € |
|-------------|-------------------|-------------|--------------|------------|
| 65071103 | textured graphite | 780 lm | 3,000 K | 229.90 |



This item is subject to discount group 1.

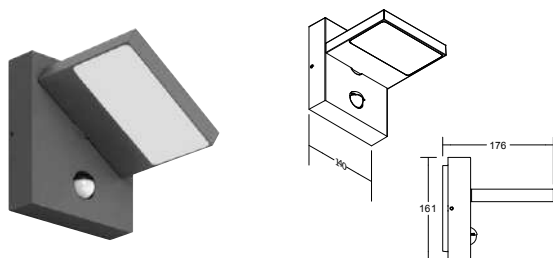

APORIA LED wall-mounted luminaire, IP54, direct, switchable

Lamp: LED, colour rendering: CRI > 80, power: 14 W, material: aluminium / polycarbonate, includes converter for connection to 230 V mains supply, switchable, with motion sensor, twilight sensor

Motion sensor:

Lighting time: adjustable from 5 seconds to 10 minutes, range: 6-10 m, detection angle: 120°, setting at twilight: 20-2.000 lux, time setting: 5 sec. - 8 min., functional mode: on/off: luminaire switches off completely after movement



| Article no. | Colour | Lumin. flux | Colour temp. | Price in € |
|-------------|-------------------|-------------|--------------|------------|
| 65131103 | textured graphite | 700 lm | 3,000 K | 239.50 |



This item is subject to discount group 1.

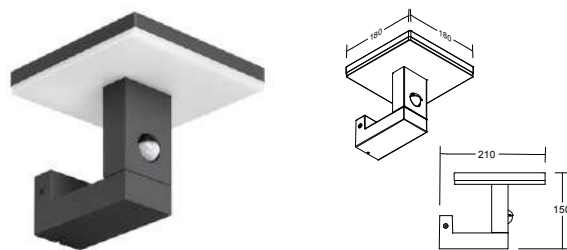

IRIS LED wall-mounted luminaire, IP54, direct, switchable

Lamp: LED, colour rendering: CRI > 80, power: 8.6 W, material: aluminium / polycarbonate, includes converter for connection to 230 V mains supply, switchable, with motion sensor, twilight sensor

Motion sensor:

Lighting time: adjustable from 5 seconds to 10 minutes, range: 6-10 m, detection angle: 120°, setting at twilight: 20-2.000 lux, time setting: 5 sec. - 8 min., functional mode: on/off: luminaire switches off completely after movement



| Article no. | Colour | Lumin. flux | Colour temp. | Price in € |
|-------------|-------------------|-------------|--------------|------------|
| 65081103 | textured graphite | 660 lm | 3,000 K | 238.40 |



This item is subject to discount group 1.

Product family APORIA



APORIA LED bollard luminaire

Article no.: 65132103

see page 419

FAGI and INO.

Wall-mounted and bollard pathway lighting.



Efficient and glare-free.

Motion sensor with a range up to 9 metres.

IP54 has complete protection against accidental contact, while dust can penetrate in small quantities. In addition, it is protected against water splashing from any direction.

IP54

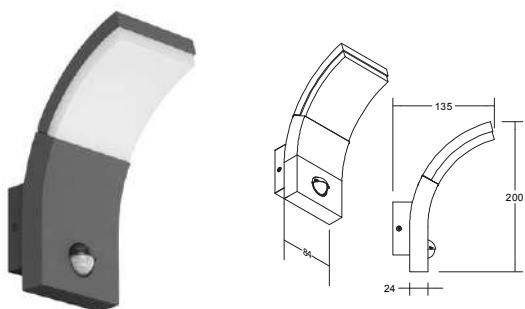

FAGI LED wall-mounted luminaire, IP54, direct, switchable

Lamp: LED, colour rendering: CRI > 80, power: 6 W, material: aluminium / polycarbonate, includes converter for connection to 230 V mains supply, switchable, with motion sensor, twilight sensor

Motion sensor:

Lighting time: adjustable from 5 seconds to 10 minutes, range: 6-10 m, detection angle: 120°, setting at twilight: 20-2.000 lux, time setting: 5 sec. - 8 min., functional mode: on/off: luminaire switches off completely after movement



| Article no. | Version | Colour | Lumin. flux | Colour temp. | Price in € |
|-------------|----------------|-------------------|-------------|--------------|------------|
| 65111103 | with sensor | textured graphite | 480 lm | 3,000 K | 242.50 |
| 65113103 | without sensor | textured graphite | 480 lm | 3,000 K | 201.00 |



This item is subject to discount group 1.

Product family FAGI



FAGI LED bollard luminaire

Article no.: 65112103

see page 421



IP54

Efficient and glare-free.

Motion sensor with a range up to 9 metres.

IP54 has complete protection against accidental contact, while dust can penetrate in small quantities. In addition, it is protected against water splashing from any direction.

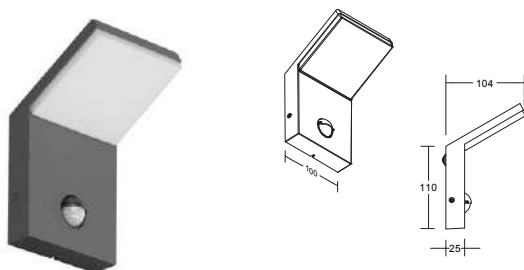

INO LED wall-mounted luminaire, IP54, direct, switchable

Lamp: LED, colour rendering: CRI > 80, power: 7.9 W, material: aluminium / polycarbonate, includes converter for connection to 230 V mains supply, switchable, with motion sensor, twilight sensor

Motion sensor:

Lighting time: adjustable from 5 seconds to 10 minutes, range: 6-10 m, detection angle: 120°, setting at twilight: 20-2.000 lux, time setting: 5 sec. - 8 min., functional mode: on/off: luminaire switches off completely after movement



| Article no. | Version | Colour | Lumin. flux | Colour temp. | Price in € |
|-------------|----------------|-------------------|-------------|--------------|------------|
| 65121103 | with sensor | textured graphite | 680 lm | 3,000 K | 241.50 |
| 65123103 | without sensor | textured graphite | 680 lm | 3,000 K | 209.00 |



This item is subject to discount group 1.

Product family INO



INO LED bollard luminaire
Article no.: 65122103

see page 421

ALLAN.



IP54 has complete protection against accidental contact, while dust can penetrate in small quantities. In addition, it is protected against water splashing from any direction.

IP54

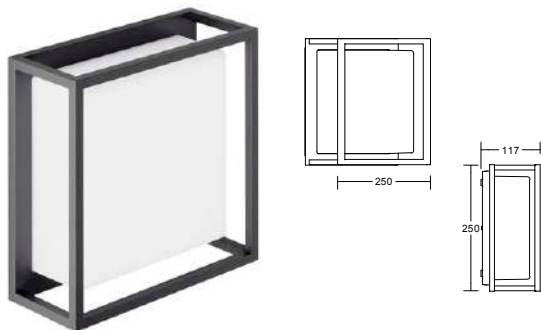

ALLAN LED wall-mounted luminaire, IP54, direct, switchable

Lamp: LED, colour rendering: CRI > 80, power: 11 W, material: aluminium / polycarbonate, includes converter for connection to 230 V mains supply, switchable



| Article no. | Colour | Lumin. flux | Colour temp. | Price in € |
|-------------|-------------------|-------------|--------------|------------|
| 65161103 | textured graphite | 900 lm | 3,000 K | 272.70 |



This item is subject to discount group 1.

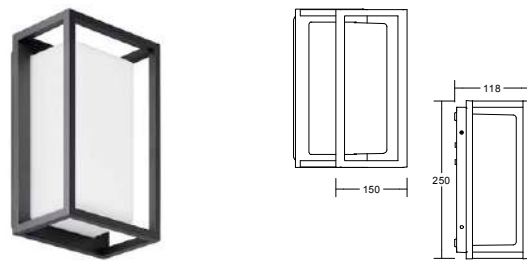

ALLAN LED wall-mounted luminaire, IP54, direct, switchable

Lamp: LED, colour rendering: CRI > 80, power: 13 W, material: aluminium / polycarbonate, includes converter for connection to 230 V mains supply, switchable



| Article no. | Colour | Lumin. flux | Colour temp. | Price in € |
|-------------|-------------------|-------------|--------------|------------|
| 65162103 | textured graphite | 660 lm | 3,000 K | 205.70 |



This item is subject to discount group 1.

KEDIRI.

Glare-free lighting with and without loudspeaker.



Excellent design.

Built-in 3 W Bluetooth loudspeaker.
Synchronous playback when multiple luminaires are connected.

IP54 has complete protection against accidental contact, while dust can penetrate in small quantities. In addition, it is protected against water splashing from any direction.

IP54

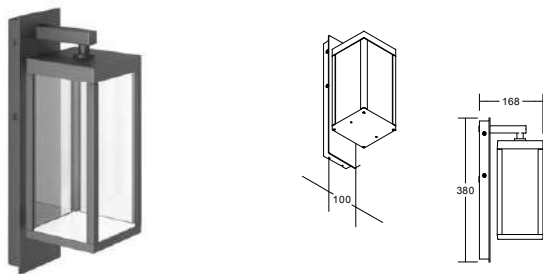

KEDIRI LED wall-mounted luminaire, IP54, direct, switchable

Lamp: LED, colour rendering: CRI > 80, power: 11 W, material: aluminium / glass / polycarbonate, includes converter for connection to 230 V mains supply, switchable



| Article no. | Colour | Lumin. flux | Colour temp. | Price in € |
|-------------|-------------------|-------------|--------------|------------|
| 65171103 | textured graphite | 750 lm | 3,000 K | 293.40 |



This item is subject to discount group 1.

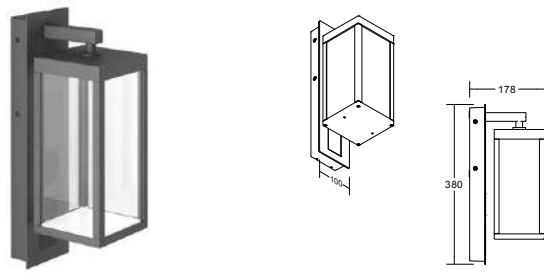

KEDIRI LED wall-mounted luminaire, IP54, direct, with 3 W loudspeaker, switchable

Lamp: LED, colour rendering: CRI > 80, power: 12 W, material: aluminium / glass / polycarbonate, includes converter for connection to 230 V mains supply, switchable, with loudspeaker



| Article no. | Colour | Lumin. flux | Colour temp. | Price in € |
|-------------|-------------------|-------------|--------------|------------|
| 65172103 | textured graphite | 800 lm | 3,000 K | 334.40 |



This item is subject to discount group 1.

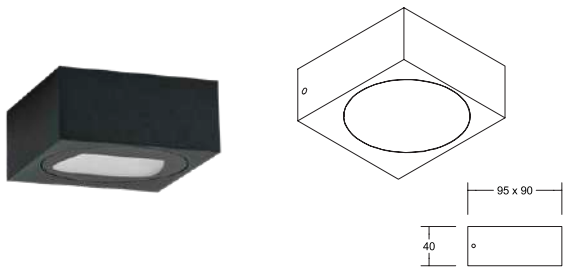

QUADER LED wall-mounted luminaire, IP65, direct, switchable

Lamp: LED, power: 5 W, material: aluminium / glass, includes converter for connection to 230 V mains supply, switchable

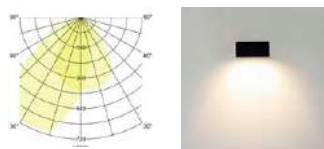

| Article no. | Colour | Lumin. flux | Colour temp. | Price in € |
|-------------|-------------------|-------------|--------------|------------|
| 10120103 | textured graphite | 310 lm | 3,000 K | 159.90 |



This item is subject to discount group 1.

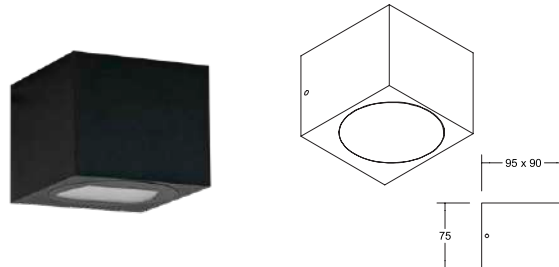

QUADER LED wall-mounted luminaire, IP65, direct / indirect, switchable

Lamp: LED, power: 2 x 4 W, material: aluminium / glass, includes converter for connection to 230 V mains supply, switchable

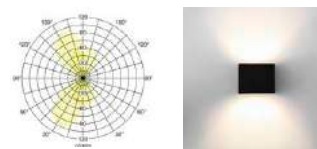

| Article no. | Colour | Lumin. flux | Colour temp. | Price in € |
|-------------|-------------------|-------------|--------------|------------|
| 10121103 | textured graphite | 620 lm | 3,000 K | 249.90 |



This item is subject to discount group 1.

Product family QUADER



QUADER bollard luminaire

Art. no. 60120103

see page 422

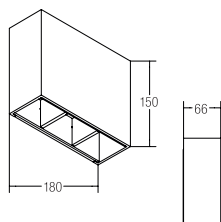

MARIBO LED wall-mounted luminaire, IP54, direct / indirect, switchable

Lamp: LED, colour rendering: CRI > 80, power: 2 x 3.7 W, beam angle: 100°, material: aluminium / glass, includes converter for connection to 230 V mains supply, switchable

Direct and indirect light emission. Wall-mounted luminaire, outer housing slides over without screws. Two flaps each on the top and bottom adjust the light emission of the respective light cone. Beam angle 2 x max. 100°.

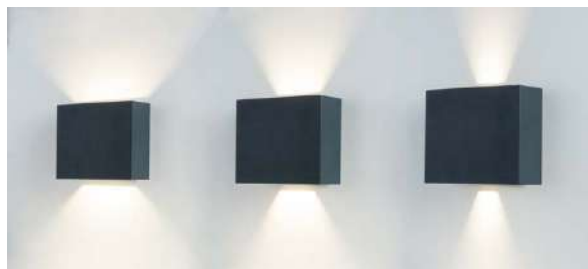

| Article no. | Colour | Lumin. flux | Colour temp. | Price in € |
|-------------|-------------------|-------------|--------------|------------|
| 60110103 | textured graphite | 424 lm | 3,000 K | 289.90 |



This item is subject to discount group 1.

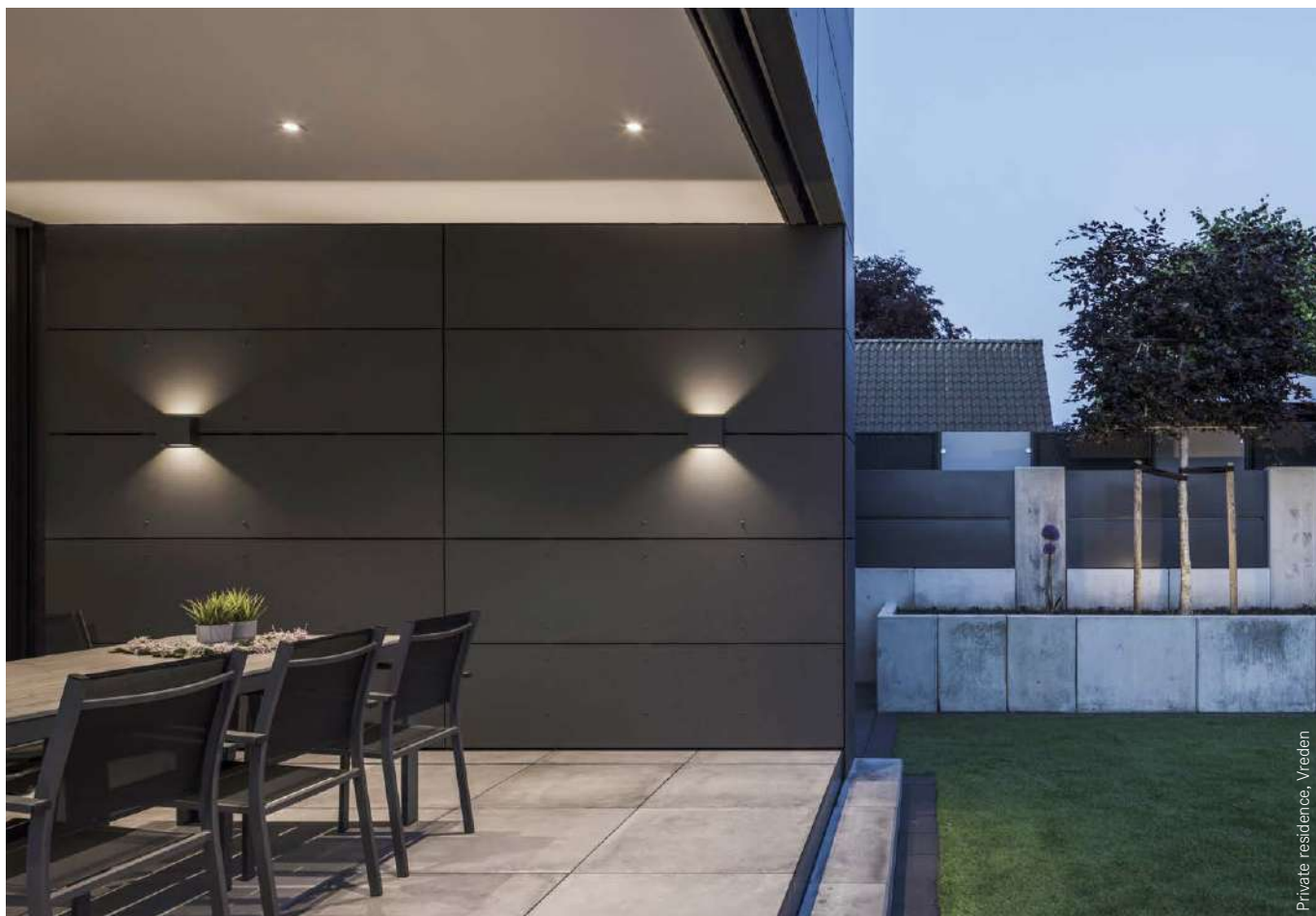

ILICIS.



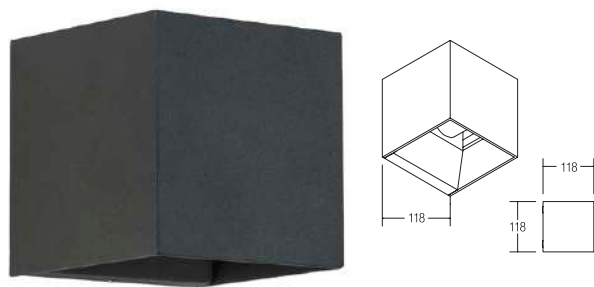

DULVIA LED wall-mounted luminaire, IP54, direct / indirect, switchable

Direct and indirect light emission (a centrally positioned light source).

Lamp: LED, colour rendering: CRI > 80, power: 10 W, material: aluminium / acrylic, includes converter for connection to 230 V mains supply, switchable



| Article no. | Colour | Lumin. flux | Colour temp. | Price in € |
|-------------|----------------|-------------|--------------|------------|
| 60025183 | textured black | 800 lm | 3,000 K | 189.90 |



This item is subject to discount group 1.

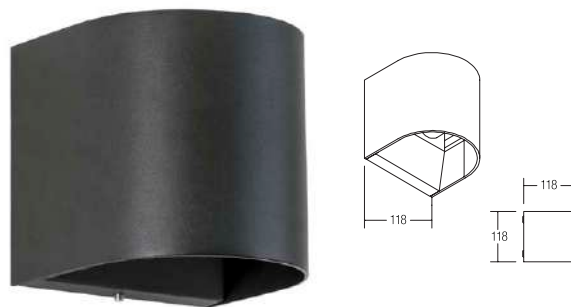

RULVIA LED wall-mounted luminaire, IP54, direct / indirect, switchable

Direct and indirect light emission (a centrally positioned light source).

Lamp: LED, colour rendering: CRI > 80, power: 10 W, material: aluminium / acrylic, includes converter for connection to 230 V mains supply, switchable



| Article no. | Colour | Lumin. flux | Colour temp. | Price in € |
|-------------|----------------|-------------|--------------|------------|
| 60026183 | textured black | 800 lm | 3,000 K | 199.90 |



This item is subject to discount group 1.

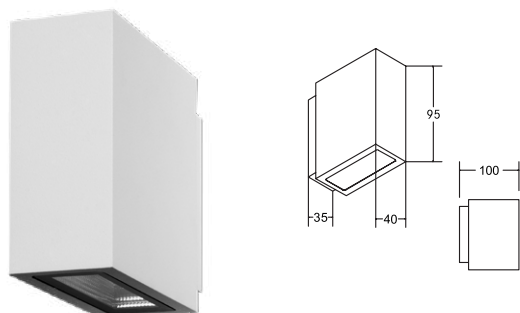

ILICIS LED wall-mounted luminaire, IP54, direct / indirect, switchable

Direct and indirect light emission.

Lamp: LED, colour rendering: CRI > 80, power: 2 x 3 W, beam angle: 60°, luminous flux: 2 x 225 lm, material: aluminium / glass, includes converter for connection to 230 V mains supply, switchable

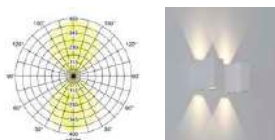

| Article no. | Colour | Lumin. flux | Colour temp. | Price in € |
|-------------|-------------------|-------------|--------------|------------|
| 10013103 | textured graphite | 450 lm | 3,000 K | 349.90 |
| 10013173 | textured white | 450 lm | 3,000 K | 349.90 |



These items are subject to discount group 1.

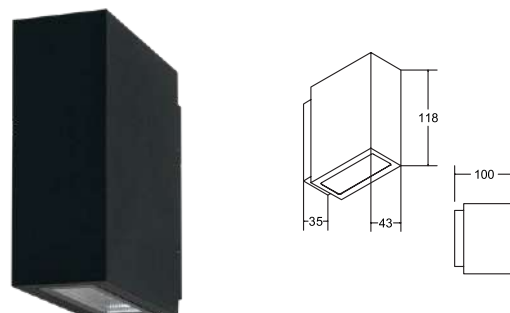

ILICIS LED wall-mounted luminaire, IP54, direct / indirect, switchable

Direct and indirect light emission.

Lamp: LED, colour rendering: CRI > 80, power: 2 x 5 W, beam angle: 60°, luminous flux: 2 x 325 lm, material: aluminium / glass, includes converter for connection to 230 V mains supply, switchable

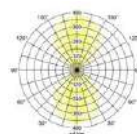

| Article no. | Colour | Lumin. flux | Colour temp. | Price in € |
|-------------|-------------------|-------------|--------------|------------|
| 10033103 | textured graphite | 650 lm | 3,000 K | 379.90 |
| 10033173 | textured white | 650 lm | 3,000 K | 379.90 |



These items are subject to discount group 1.

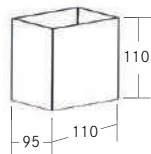

IDAS LED wall-mounted luminaire, IP54, direct / indirect, switchable

Direct and indirect light emission (a centrally positioned light source).

Lamp: LED, colour rendering: CRI > 80, power: 6 W, material: aluminium / polycarbonate, includes converter for connection to 230 V mains supply, switchable



| Article no. | Colour | Lumin. flux | Colour temp. | Price in € |
|-------------|-------------------|-------------|--------------|------------|
| 65141103 | textured graphite | 400 lm | 3,000 K | 150.10 |



This item is subject to discount group 1.

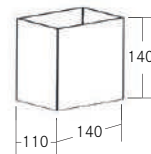

IDAS LED wall-mounted luminaire, IP54, direct / indirect, switchable

Direct and indirect light emission (a centrally positioned light source).

Lamp: LED, colour rendering: CRI > 80, power: 12 W, material: aluminium / polycarbonate, includes converter for connection to 230 V mains supply, switchable



| Article no. | Colour | Lumin. flux | Colour temp. | Price in € |
|-------------|-------------------|-------------|--------------|------------|
| 65142103 | textured graphite | 800 lm | 3,000 K | 179.00 |



This item is subject to discount group 1.

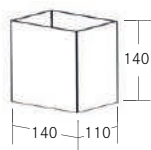

IDAS LED wall-mounted luminaire, IP54, direct, switchable

Lamp: LED, colour rendering: CRI > 80, power: 3 W, material: aluminium / polycarbonate, includes converter for connection to 230 V mains supply, switchable

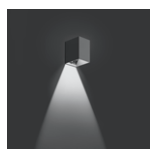

| Article no. | Colour | Lumin. flux | Colour temp. | Price in € |
|-------------|-------------------|-------------|--------------|------------|
| 65143103 | textured graphite | 200 lm | 3,000 K | 139.00 |



This item is subject to discount group 1.

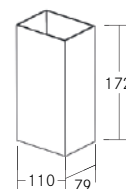

IDAS LED wall-mounted luminaire, IP54, direct / indirect, switchable

Direct and indirect light emission (a centrally positioned light source).

Lamp: LED, colour rendering: CRI > 80, power: 6 W, material: aluminium / polycarbonate, includes converter for connection to 230 V mains supply, switchable



| Article no. | Colour | Lumin. flux | Colour temp. | Price in € |
|-------------|-------------------|-------------|--------------|------------|
| 65144103 | textured graphite | 400 lm | 3,000 K | 152.10 |



This item is subject to discount group 1.

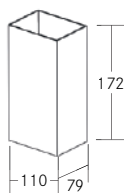
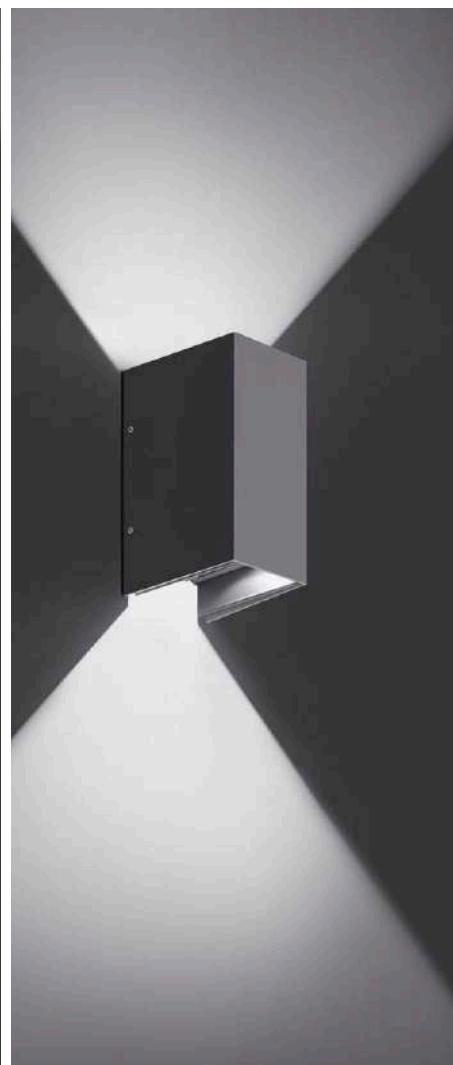
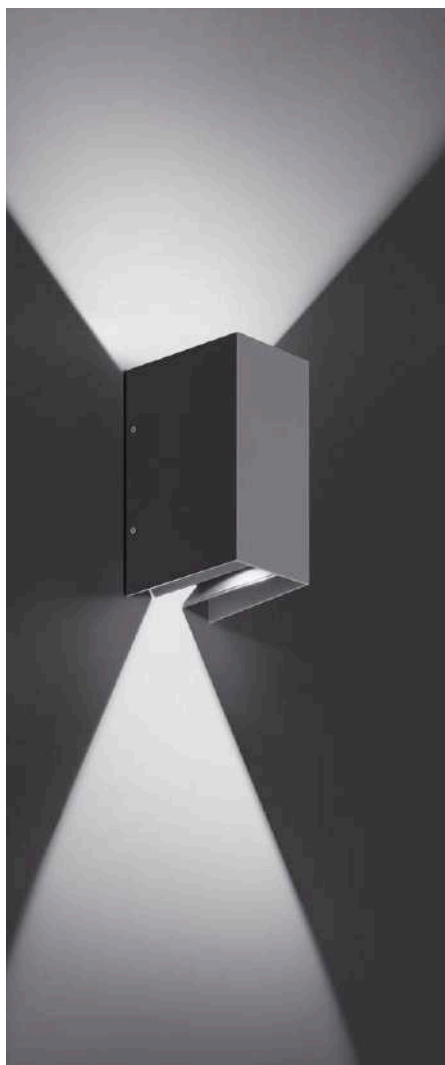
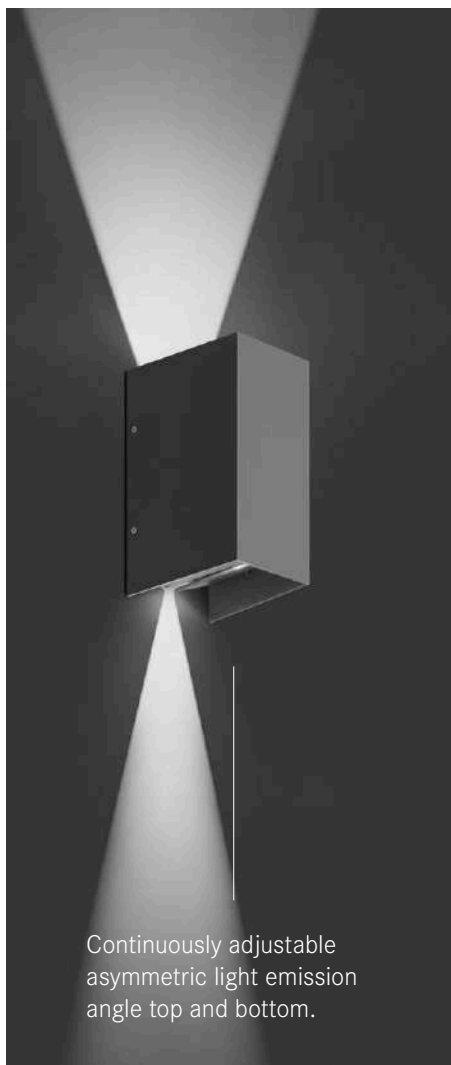

COLIAS LED wall-mounted luminaire, IP54, direct / indirect, switchable

Lamp: LED, colour rendering: CRI > 80, power: 2 x 3 W, material: aluminium / glass, includes converter for connection to 230 V mains supply, switchable



| Article no. | Colour | Lumin. flux | Colour temp. | Price in € |
|-------------|-------------------|-------------|--------------|------------|
| 65151103 | textured graphite | 500 lm | 3,000 K | 139.00 |



This item is subject to discount group 1.

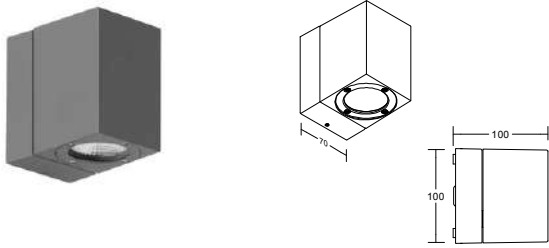

SELIA LED wall-mounted luminaire, IP54, direct, switchable

Lamp: LED, colour rendering: CRI > 80, power: 7 W, material: aluminium / glass, includes converter for connection to 230 V mains supply, switchable



| Article no. | Colour | Lumin. flux | Colour temp. | Price in € |
|-------------|-------------------|-------------|--------------|------------|
| 65231103 | textured graphite | 530 lm | 3,000 K | 192.90 |



This item is subject to discount group 1.

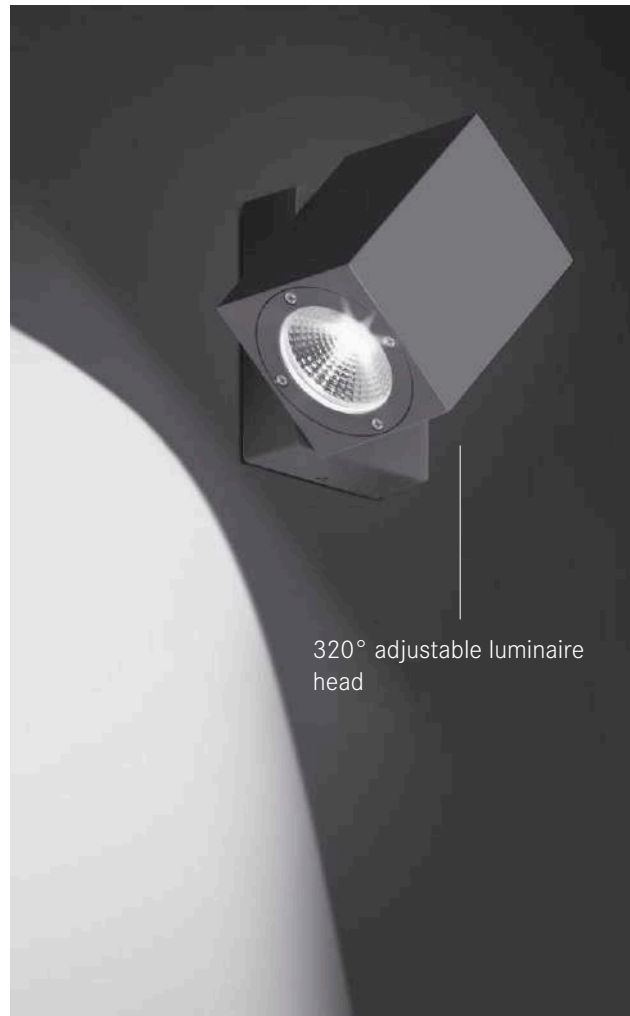

320° adjustable luminaire head

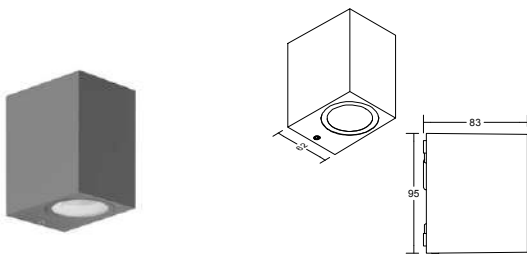

SELIA LED wall-mounted luminaire, IP54, direct, switchable

Lamp: LED, power: 7 W, material: aluminium / glass, includes converter for connection to 230 V mains supply, switchable

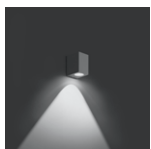

| Article no. | Colour | Lumin. flux | Colour temp. | Price in € |
|-------------|-------------------|-------------|--------------|------------|
| 65232103 | textured graphite | 604 lm | 3,000 K | 167.20 |



This item is subject to discount group 1.

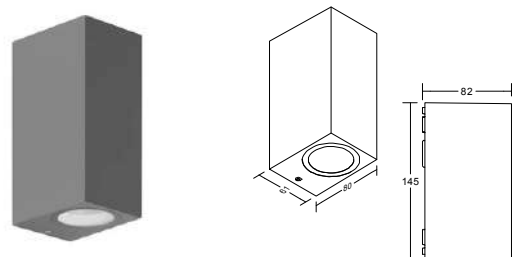

SELIA LED wall-mounted luminaire, IP54, direct / indirect, switchable

Lamp: LED, colour rendering: CRI > 80, power: 2 x 7 W, material: aluminium / glass, includes converter for connection to 230 V mains supply, switchable



| Article no. | Colour | Lumin. flux | Colour temp. | Price in € |
|-------------|-------------------|-------------|--------------|------------|
| 65233103 | textured graphite | 1,150 lm | 3,000 K | 233.70 |



This item is subject to discount group 1.

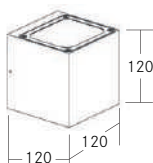

SELIA LED wall-mounted luminaire, IP54, direct, switchable

Lamp: LED, colour rendering: CRI > 80, power: 9 W, material: aluminium / plastic, includes converter for connection to 230 V mains supply, switchable



| Article no. | Colour | Lumin. flux | Colour temp. | Price in € |
|-------------|-------------------|-------------|--------------|------------|
| 65234103 | textured graphite | 625 lm | 3,000 K | 172.40 |



This item is subject to discount group 1.

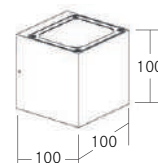

SELIA LED wall-mounted luminaire, IP54, direct / indirect, switchable

Lamp: LED, colour rendering: CRI > 80, power: 2 x 5 W, material: aluminium / plastic, includes converter for connection to 230 V mains supply, switchable



| Article no. | Colour | Lumin. flux | Colour temp. | Price in € |
|-------------|-------------------|-------------|--------------|------------|
| 65235103 | textured graphite | 750 lm | 3,000 K | 167.20 |



This item is subject to discount group 1.

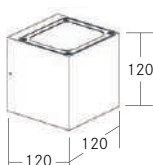

SELIA LED wall-mounted luminaire, IP54, direct / indirect, switchable

Lamp: LED, colour rendering: CRI > 80, power: 2 x 9 W, material: aluminium / plastic, includes converter for connection to 230 V mains supply, switchable



| Article no. | Colour | Lumin. flux | Colour temp. | Price in € |
|-------------|-------------------|-------------|--------------|------------|
| 65236103 | textured graphite | 1,300 lm | 3,000 K | 206.60 |



This item is subject to discount group 1.

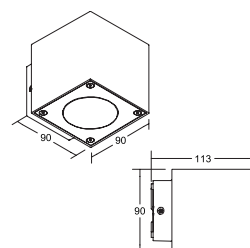

SELIA LED wall-mounted luminaire, IP54, direct / indirect, switchable

Lamp: LED, colour rendering: CRI > 80, power: 2 x 3 W, material: aluminium / glass, includes converter for connection to 230 V mains supply, switchable



| Article no. | Colour | Lumin. flux | Colour temp. | Price in € |
|-------------|-------------------|-------------|--------------|------------|
| 65237103 | textured graphite | 480 lm | 3,000 K | 171.30 |



This item is subject to discount group 1.

SITTA.

Rectilinear design with elegant lighting effect.

Continuously adjustable symmetric light emission angle top and bottom.

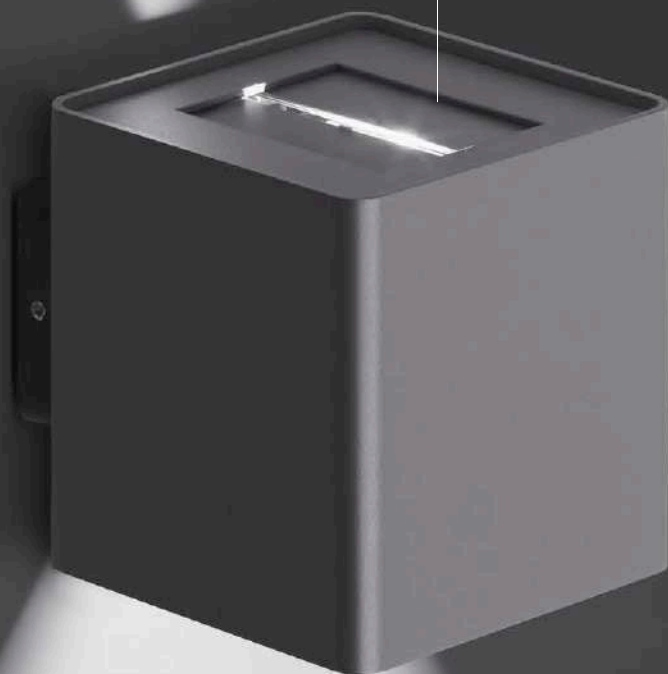

IP54

IP54 has complete protection against accidental contact, while dust can penetrate in small quantities. In addition, it is protected against water splashing from any direction.

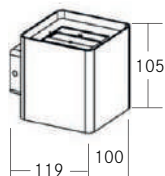

SITTA LED wall-mounted luminaire, IP54, direct / indirect, switchable

Lamp: LED, colour rendering: CRI > 80, power: 2 x 7 W, material: aluminium / glass, includes converter for connection to 230 V mains supply, switchable



| Article no. | Colour | Lumin. flux | Colour temp. | Price in € |
|-------------|-------------------|-------------|--------------|------------|
| 65091103 | textured graphite | 1,200 lm | 3,000 K | 221.30 |



This item is subject to discount group 1.

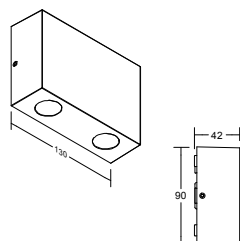

ELLA LED wall-mounted luminaire, IP54, direct / indirect, switchable

Lamp: LED, colour rendering: CRI > 80, power: 4 x 1 W, material: aluminium / glass, includes converter for connection to 230 V mains supply, switchable

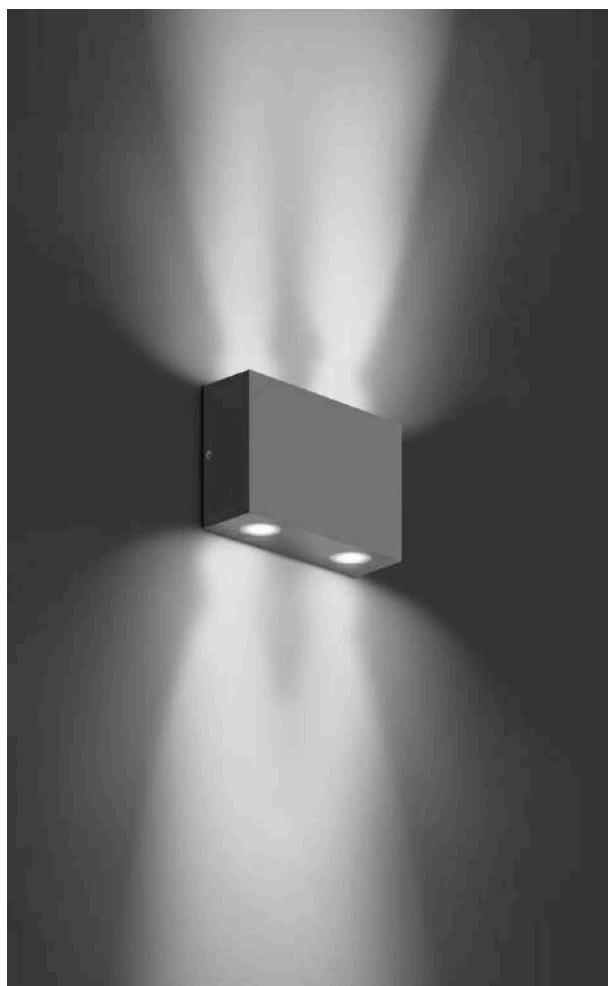
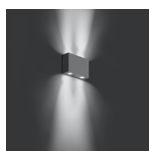

| Article no. | Colour | Lumin. flux | Colour temp. | Price in € |
|-------------|-------------------|-------------|--------------|------------|
| 65241103 | textured graphite | 390 lm | 3,000 K | 155.00 |



This item is subject to discount group 1.

CLIQ.

Effective staging
of facades.

Adjustable light emission
by sliding the shade.

IP65

IP65 has complete protection against accidental contact. Dust cannot penetrate and it is protected against jets of water in any direction.

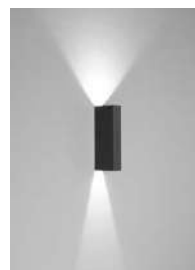
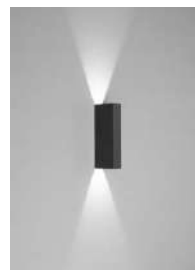
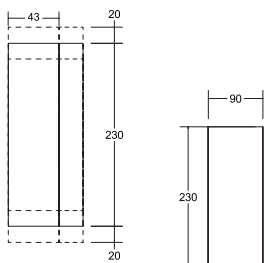

CLIQ LED wall-mounted luminaire, IP65, switchable

Direct and indirect light emission. Three-step height-adjustable shade for setting different light emissions.

Lamp: LED, colour rendering: CRI > 90, power: 2 x 4.6 W, luminous flux: 2 x 190 lm, material: aluminium / glass, includes converter for connection to 230 V mains supply, switchable

| Article no. | Colour | Lumin. flux | Colour temp. | Price in € |
|-------------|----------------|-------------|--------------|------------|
| 60127173 | textured white | 790 lm | 3,000 K | 179.90 |
| 60127183 | textured black | 790 lm | 3,000 K | 179.90 |
| 60127253 | matt aluminium | 790 lm | 3,000 K | 179.90 |



* Must be mounted on a level surface.

These items are subject to discount group 1.

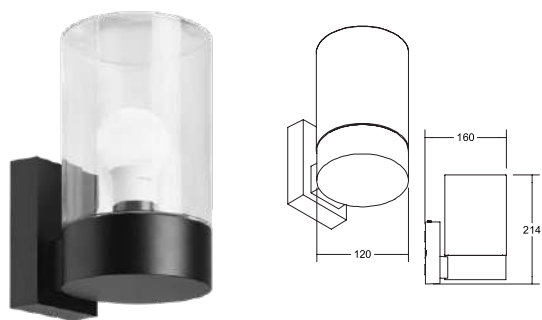

COOQUEE wall-mounted luminaire, IP65

Lamp: for LED retrofit lamp, lamp holder: E27,
power: max. 8 W, material: aluminium / glass / plastic
Lamp not included in scope of supply.

| Article no. | Colour | Price in € |
|-------------|----------------|------------|
| 60140180 | textured black | 169.90 |

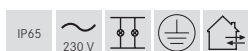

Accessories: replacement glass 81070000
(with silicone seal)

This item is subject to discount group 1.



Product family COOQUEE

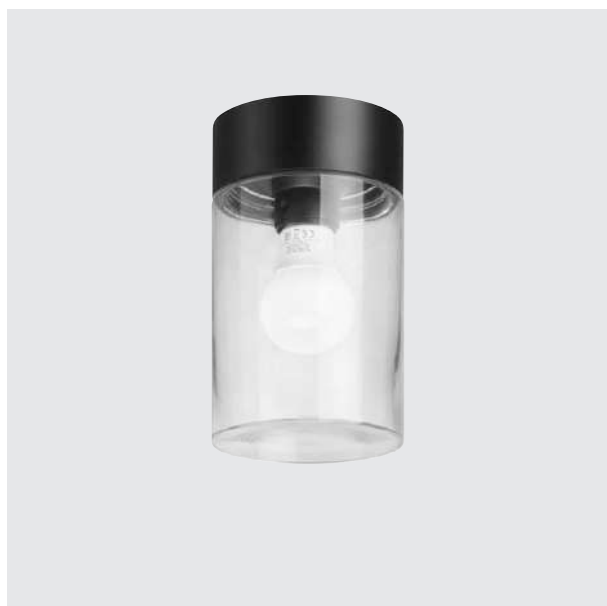

COOQUEE ceiling-mounted luminaire

Article no.: 60141180

see page 312



COOQUEE bollard luminaire

Article no.: 60070180

see page 424

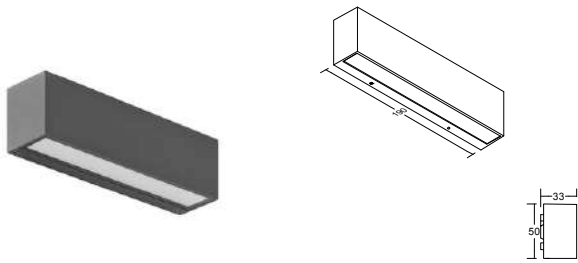

DARBEE LED wall-mounted luminaire, IP65, direct, switchable

Lamp: LED, colour rendering: CRI > 80, power: 3.1 W, material: aluminium / glass, includes converter for connection to 230 V mains supply, switchable



| Article no. | Colour | Lumin. flux | Colour temp. | Price in € |
|-------------|-------------------|-------------|--------------|------------|
| 65251103 | textured graphite | 208 lm | 3,000 K | 150.60 |



This item is subject to discount group 1.

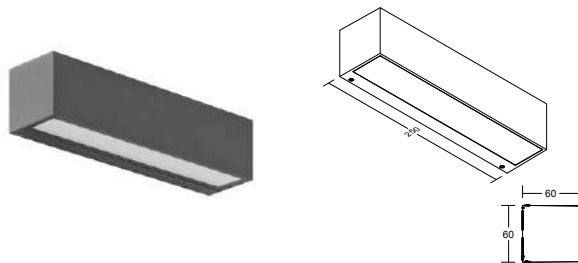
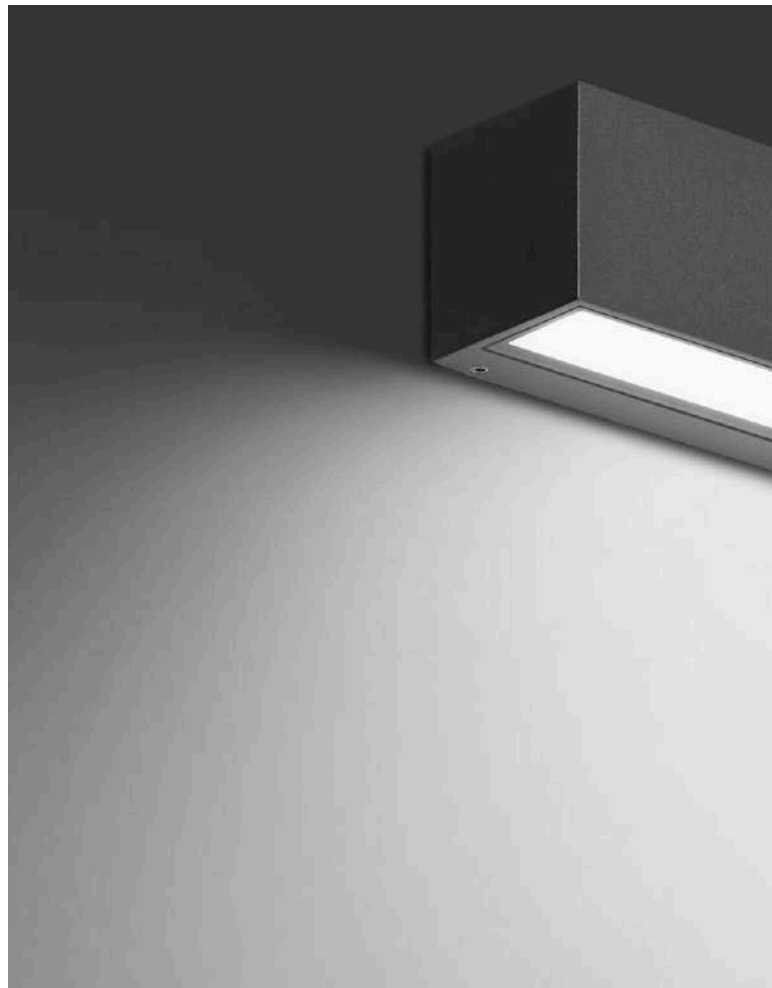

DARBEE LED wall-mounted luminaire, IP65, direct, switchable

Lamp: LED, colour rendering: CRI > 80, power: 9 W, material: aluminium / glass, includes converter for connection to 230 V mains supply, switchable



| Article no. | Colour | Lumin. flux | Colour temp. | Price in € |
|-------------|-------------------|-------------|--------------|------------|
| 65252103 | textured graphite | 600 lm | 3,000 K | 197.60 |



This item is subject to discount group 1.

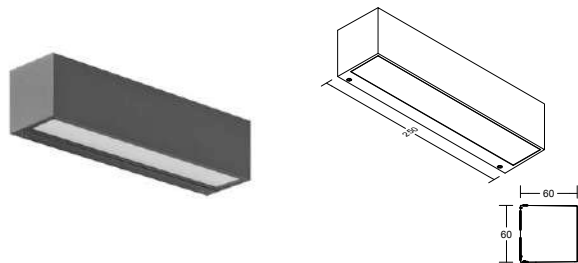

DARBEE LED wall-mounted luminaire, IP65, direct / indirect, switchable

Lamp: LED, colour rendering: CRI > 80, power: 2 x 9 W, material: aluminium / glass, includes converter for connection to 230 V mains supply, switchable



| Article no. | Colour | Lumin. flux | Colour temp. | Price in € |
|-------------|-------------------|-------------|--------------|------------|
| 65253103 | textured graphite | 1,200 lm | 3,000 K | 222.30 |



This item is subject to discount group 1.



Luminaires can be mounted both horizontally and vertically.

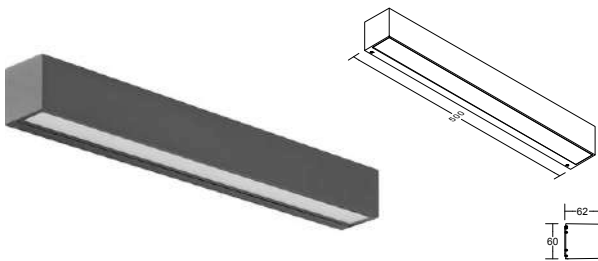

DARBEE LED wall-mounted luminaire, IP65, direct, switchable

Lamp: LED, colour rendering: CRI > 80, power: 18 W, material: aluminium / glass, includes converter for connection to 230 V mains supply, switchable



| Article no. | Colour | Lumin. flux | Colour temp. | Price in € |
|-------------|-------------------|-------------|--------------|------------|
| 65254103 | textured graphite | 1,155 lm | 3,000 K | 235.60 |



This item is subject to discount group 1.

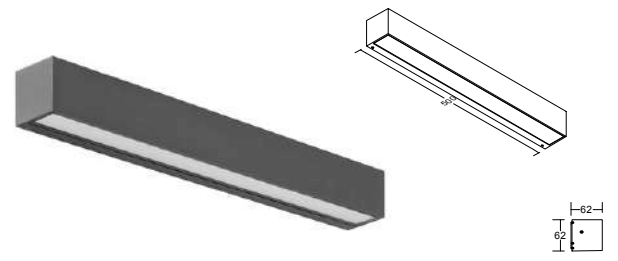

DARBEE LED wall-mounted luminaire, IP65, direct / indirect, switchable

Lamp: LED, colour rendering: CRI > 80, power: 2 x 18 W, material: aluminium / glass, includes converter for connection to 230 V mains supply, switchable



| Article no. | Colour | Lumin. flux | Colour temp. | Price in € |
|-------------|-------------------|-------------|--------------|------------|
| 65255103 | textured graphite | 2,310 lm | 3,000 K | 299.40 |



This item is subject to discount group 1.



Wall-mounted luminaire, V4A, IP44, GU10, direct

Direct light emission.

Lamp: for LED retrofit lamp, lamp holder: GU10, power: max. 35 W, material: V4A stainless steel / glass

| Article no. | Colour | Price in € |
|-------------|-----------------|------------|
| 35001420 | stainless steel | 269.90 |

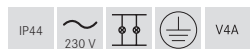

This item is subject to discount group 1.

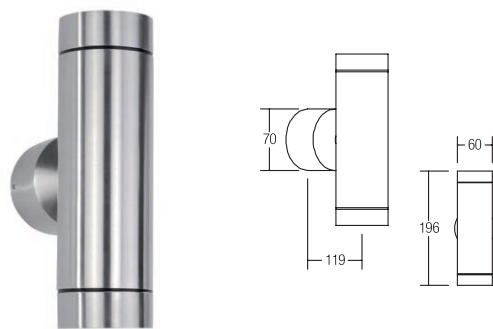

Wall-mounted luminaire, V4A, IP44, GU10, direct / indirect

Direct and indirect light emission.

Lamp: for LED retrofit lamp, lamp holder: GU10, power: max. 35 W each, material: V4A stainless steel / glass

| Article no. | Colour | Price in € |
|-------------|-----------------|------------|
| 3177 | stainless steel | 319.90 |

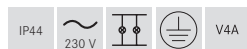

This item is subject to discount group 1.



MARK LED wall-mounted luminaire, IP65, switchable

Lamp: LED, colour rendering: CRI > 80, power: 4 W, beam angle: 65°, material: aluminium, includes converter for connection to 230 V mains supply, switchable

| Article no. | Colour | Lumin. flux | Colour temp. | Price in € |
|-------------|----------------|-------------|--------------|------------|
| 10170183 | textured black | 320 lm | 3,000 K | 109.90 |



This item is subject to discount group 1.

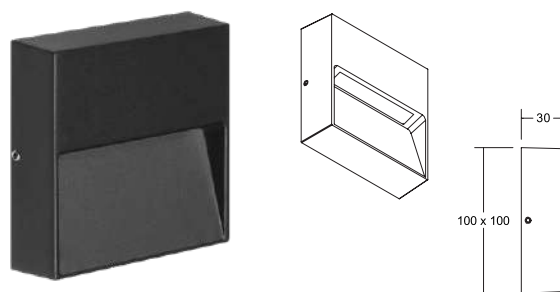

MARK LED wall-mounted luminaire, IP65, switchable

Lamp: LED, colour rendering: CRI > 80, power: 4 W, beam angle: 65°, material: aluminium, includes converter for connection to 230 V mains supply, switchable

| Article no. | Colour | Lumin. flux | Colour temp. | Price in € |
|-------------|----------------|-------------|--------------|------------|
| 10171183 | textured black | 320 lm | 3,000 K | 114.90 |



This item is subject to discount group 1.

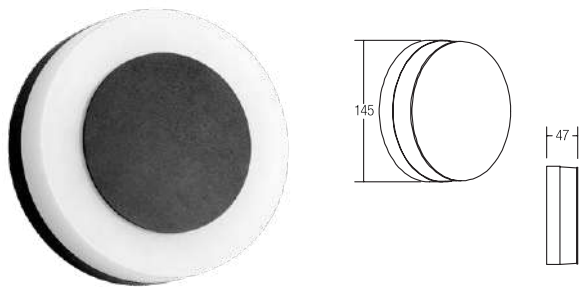

DRONA LED wall-mounted luminaire, IP54, switchable

With interchangeable front panel for purely indirect or direct / indirect light emission. Both front panels (magnetically attached) are included in the scope of supply for customer choice.

Lamp: LED, colour rendering: CRI > 80, power: 9 W, material: aluminium / plastic, includes converter for connection to 230 V mains supply, switchable

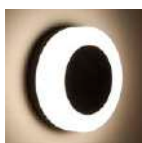

| Article no. | Colour | Lumin. flux | Colour temp. | Price in € |
|-------------|-----------------|-------------|--------------|------------|
| 10030173 | textured white | 665 lm | 3,000 K | 139.90 |
| 10030183 | textured black | 665 lm | 3,000 K | 139.90 |
| 10030693 | textured silver | 665 lm | 3,000 K | 139.90 |



These items are subject to discount group 1.

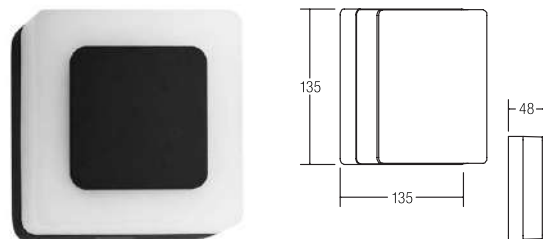

DRONA LED wall-mounted luminaire, IP54, switchable

With interchangeable front panel for purely indirect or direct / indirect light emission. Both front panels (magnetically attached) are included in the scope of supply for customer choice.

Lamp: LED, colour rendering: CRI > 80, power: 9 W, material: aluminium / plastic, includes converter for connection to 230 V mains supply, switchable



| Article no. | Colour | Lumin. flux | Colour temp. | Price in € |
|-------------|-----------------|-------------|--------------|------------|
| 10034173 | textured white | 665 lm | 3,000 K | 149.90 |
| 10034183 | textured black | 665 lm | 3,000 K | 149.90 |
| 10034693 | textured silver | 665 lm | 3,000 K | 149.90 |



These items are subject to discount group 1.

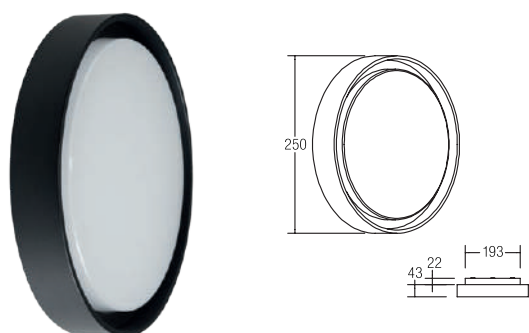

BARTIE LED wall & ceiling-mounted luminaire, IP54, switchable

Lamp: LED, colour rendering: CRI > 80, power: 14 W, beam angle: 110°, material: aluminium / acrylic, includes converter for connection to 230 V mains supply, switchable

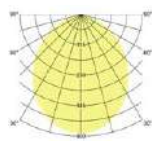

| Article no. | Colour | Lumin. flux | Colour temp. | Price in € |
|-------------|----------------|-------------|--------------|------------|
| 60107183 | textured black | 1,210 lm | 3,000 K | 219.90 |



This item is subject to discount group 1.

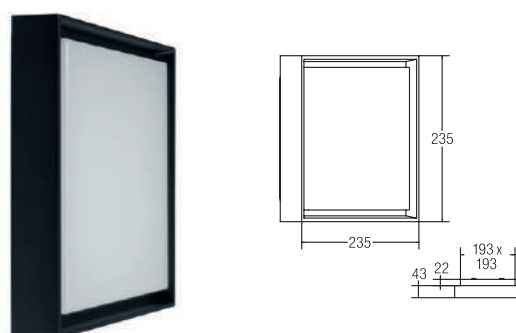

BARTIE LED wall & ceiling-mounted luminaire, IP54, switchable

Lamp: LED, colour rendering: CRI > 80, power: 14 W, beam angle: 110°, material: aluminium / acrylic, includes converter for connection to 230 V mains supply, switchable

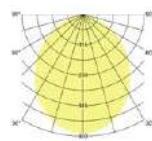

| Article no. | Colour | Lumin. flux | Colour temp. | Price in € |
|-------------|----------------|-------------|--------------|------------|
| 60108183 | textured black | 1,230 lm | 3,000 K | 229.90 |



This item is subject to discount group 1.

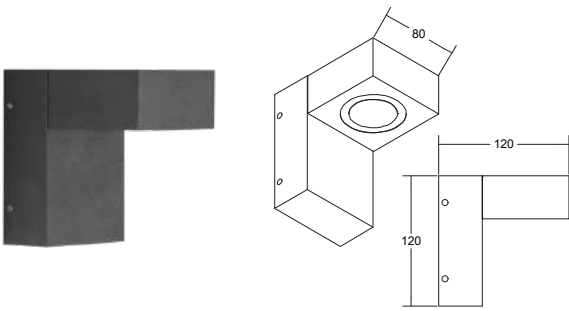

LANTERN LED wall-mounted luminaire, IP65, direct, switchable

Lamp: LED, colour rendering: CRI > 90, power: 9 W, material: aluminium / plastic, includes converter for connection to 230 V mains supply, switchable



| Article no. | Colour | Lumin. flux | Colour temp. | Price in € |
|-------------|-------------------|-------------|--------------|------------|
| 10106103 | textured graphite | 520 lm | 3,000 K | 227.80 |



This item is subject to discount group 1.

Product family LANTERN



LANTERN bollard luminaire

Article no.: 60006103, height 600 mm

see page 423

Article no.: 60036103, height 800 mm

see page 423

LANTERN.

Minimalist design for modern architecture.



IP65

IP65 has complete protection against accidental contact. Dust cannot penetrate and it is protected against jets of water in any direction.

12

Solar luminaires.

Environmentally sustainable lighting
for house and garden.

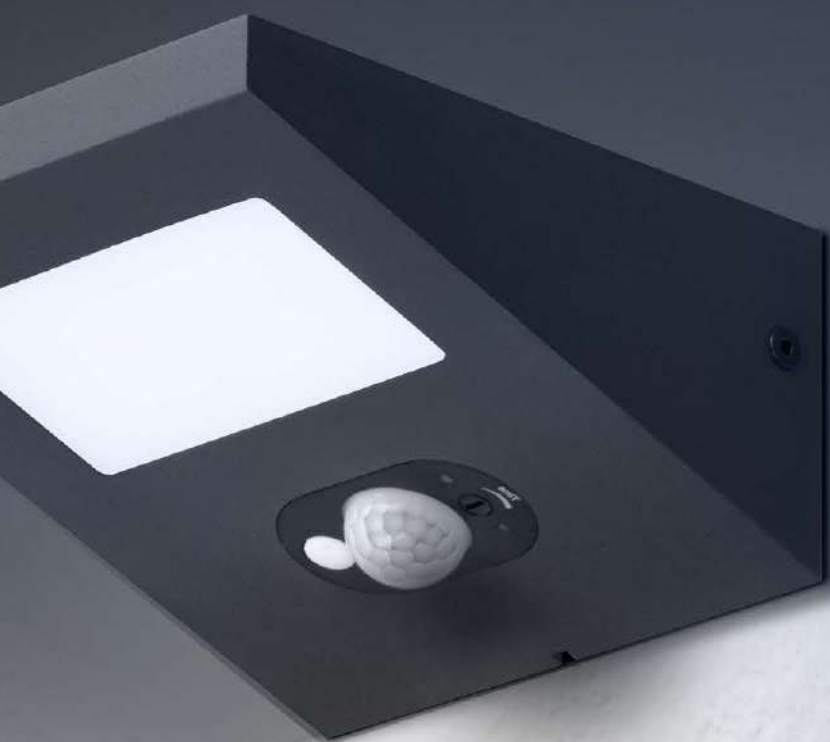

LIGEA and ARGUS.

Modern facade lighting
without electricity.

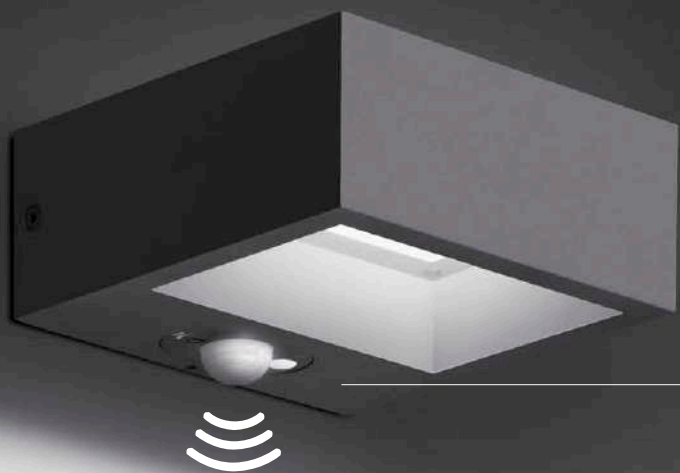

Motion sensor with a
range of 4 to 6 metres.

IP54

IP54 has complete protection against accidental contact, while dust can penetrate in small quantities. In addition, it is protected against water splashing from any direction.

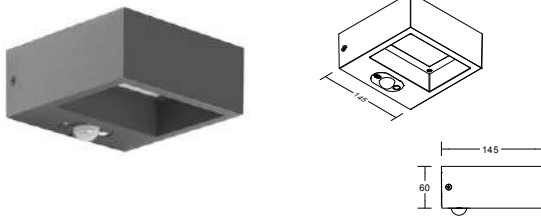

LIGEA LED wall-mounted solar luminaire, IP54, direct

Lamp: LED, colour rendering: CRI > 80, power: 1.4 W, material: aluminium / polycarbonate

- Charging time: 6 hours at 100,000 lux solar radiation.
- Working time: 7 hours at 100 % output.
- Working time: 18 hours at 20 % output.

Lighting time: adjustable from 8 seconds to 8 minutes, range: between 4 and 6 metres, detection angle: 120°.

Functional modes:

1. On/off variant: luminaire switches off completely after movement
2. Orientation light: brightness is reduced by 15 % after movement



| Article no. | Colour | Lumin. flux | Colour temp. | Price in € |
|-------------|-------------------|-------------|--------------|------------|
| 65281103 | textured graphite | 150 lm | 3,000 K | 240.70 |



This item is subject to discount group 1.



Solar panel top

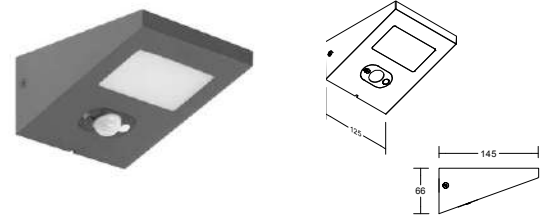

ARGUS LED wall-mounted solar luminaire, IP54, direct

Lamp: LED, colour rendering: CRI > 80, power: 1.4 W, material: aluminium / polycarbonate

- Charging time: 6 hours at 100,000 lux solar radiation.
- Working time: 7 hours at 100 % output.
- Working time: 18 hours at 20 % output.

Lighting time: adjustable from 8 seconds to 8 minutes, range: between 4 and 6 metres, detection angle: 120°.

Functional modes:

1. On/off variant: luminaire switches off completely after movement
2. Orientation light: brightness is reduced by 15 % after movement



| Article no. | Colour | Lumin. flux | Colour temp. | Price in € |
|-------------|-------------------|-------------|--------------|------------|
| 65291103 | textured graphite | 150 lm | 3,000 K | 213.00 |



This item is subject to discount group 1.



Solar panel top

VARIA.

Solar luminaire for flexible use.

Can also be used as a table lamp.

Can also be recharged via a USB port (Type C).

Over 9 hours battery runtime.

Integrated twilight sensor.

Adjustable light colour
2,700 K or 3,000 K.

Continuously adjustable
light intensity,
5% - 100 %.

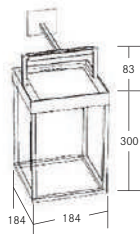

Lamp underneath

VARIA LED wall-mounted solar luminaire, IP65, direct

Lamp: LED, colour rendering: CRI > 80, power: 2.2 W, material: aluminium / glass, includes USB-C charging cable and ceiling/wall bracket

- 2 x 2,200 mA lithium batteries.
- Charging time: 6 hours.
- Working time: 11 hours at 100 % output.



| Article no. | Colour | Lumin. flux | Colour temp. | Price in € |
|-------------|-------------------|-------------|--------------|------------|
| 65311103 | textured graphite | 150 lm | 3,000 K | 325.40 |



This item is subject to discount group 1.



Can also be used as a table lamp.

Can also be recharged via a USB port (Type C).

Over 9 hours battery runtime.

Integrated twilight sensor.

Adjustable light colour 2,700 K or 3,000 K.

Continuously adjustable light intensity, 5% - 100%.

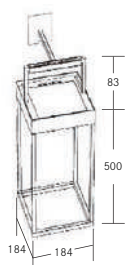

Lamp underneath

VARIA LED wall-mounted solar luminaire, IP65, direct

Lamp: LED, colour rendering: CRI > 80, power: 2.2 W, material: aluminium / glass, includes USB-C charging cable and ceiling/wall bracket

- 2 x 2,200 mA lithium batteries.
- Charging time: 6 hours.
- Working time: 11 hours at 100 % output.

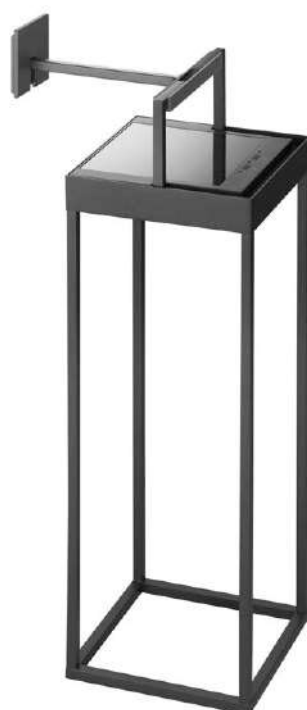

| Article no. | Colour | Lumin. flux | Colour temp. | Price in € |
|-------------|-------------------|-------------|--------------|------------|
| 65312103 | textured graphite | 150 lm | 3,000 K | 339.50 |



This item is subject to discount group 1.

CORIDON.

Solar floor lamp for a cosy atmosphere.



Continuously adjustable light intensity.

Can also be recharged via a USB port (Type C).

Over 9 hours battery runtime.

Integrated twilight sensor.

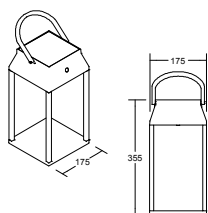

CORIDON LED solar luminaire, IP44, direct

Lamp: LED, colour rendering: CRI > 80, power: 3 W, material: aluminium / polycarbonate, includes USB-C charging cable and 2 x 2,200 mA lithium batteries

- Charging time: sun: 16-17 hours
- Charging time: USB charging: 6-7 hours
- Working time: 10 hours



| Article no. | Colour | Lumin. flux | Colour temp. | Price in € |
|-------------|-------------------|-------------|--------------|------------|
| 65301103 | textured graphite | 156 lm | 3,000 K | 252.60 |

IP44



This item is subject to discount group 1.

RUBI.

Integrated twilight sensor.

Includes ground spike.

Integrated twilight sensor.

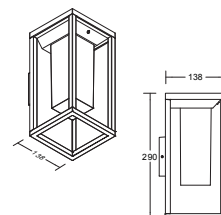
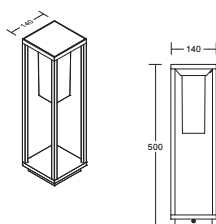

RUBI LED solar pedestal luminaire, IP54, direct

For mounting as ground spike or pedestal luminaire.

Lamp: LED, colour rendering: CRI > 80, power: 3 W, material: aluminium / polycarbonate, includes 1 x 2,200 mA lithium battery and ground spike

- Charging time: sun: 6-8 hours.
- Working time: 2-3 hours at 100 % output.
- Working time: 20-25 hours at 15 % output.



RUBI LED wall-mounted solar luminaire, IP54, direct

Lamp: LED, colour rendering: CRI > 80, power: 2.2 W, material: aluminium / polycarbonate, includes 1 x 2,200 mA lithium batteries

- Charging time: sun: 6-8 hours.
- Working time: 2-3 hours at 100 % output.
- Working time: 20-25 hours at 15 % output.



| Article no. | Colour | Lumin. flux | Colour temp. | Price in € |
|-------------|-------------------|-------------|--------------|------------|
| 65321103 | textured graphite | 156 lm | 3,000 K | 231.80 |

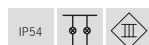

This item is subject to discount group 1.

| Article no. | Colour | Lumin. flux | Colour temp. | Price in € |
|-------------|-------------------|-------------|--------------|------------|
| 65322103 | textured graphite | 167 lm | 3,000 K | 237.80 |



This item is subject to discount group 1.

CAMERON and CAMPANA.

Cosy ambience for natural recharging.

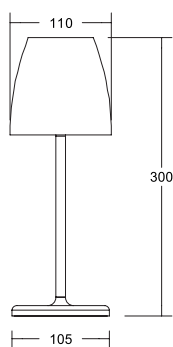

CAMERON LED solar table lamp, IP54, touch dim, height 300 mm

NEW

Base dimensions: Ø105 mm

Lamp: LED, colour rendering: CRI >80, power: 2.2 W, beam angle: 145°, material: aluminium / polycarbonate, touch dim function

Scope of supply: includes USB-C charging cable

- Charging time: 4.5 hours
- Operating time: 7.5 hours
- Solar time: 20 hours

| Article no. | Colour | Lumin. flux | Colour temp. | Price in € |
|-------------|--------------------|-------------|--------------|------------|
| 60331183 | NEW textured black | 150 lm | 3,000 K | 99.90 |



This item is subject to discount group 1.

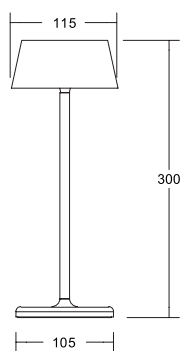

CAMPANA LED solar table lamp, IP54, touch dim, height 300 mm

NEW

Base dimensions: Ø105 mm

Lamp: LED, colour rendering: CRI >80, power: 2.2 W, material: aluminium / polycarbonate, touch dim function

Scope of supply: includes USB-C charging cable

- Charging time: 4.5 hours
- Operating time: 7.5 hours
- Solar time: 20 hours

| Article no. | Colour | Lumin. flux | Colour temp. | Price in € |
|-------------|---------------------------|-------------|--------------|------------|
| 60332183 | NEW textured black | 150 lm | 3,000 K | 99.90 |



This item is subject to discount group 1.

Sizes in mm | All prices are recommended retail prices (RRP) in euros without VAT. Errors excepted. | Orders are placed in accordance with our General Terms and Conditions of Sale printed on page 486 onwards.

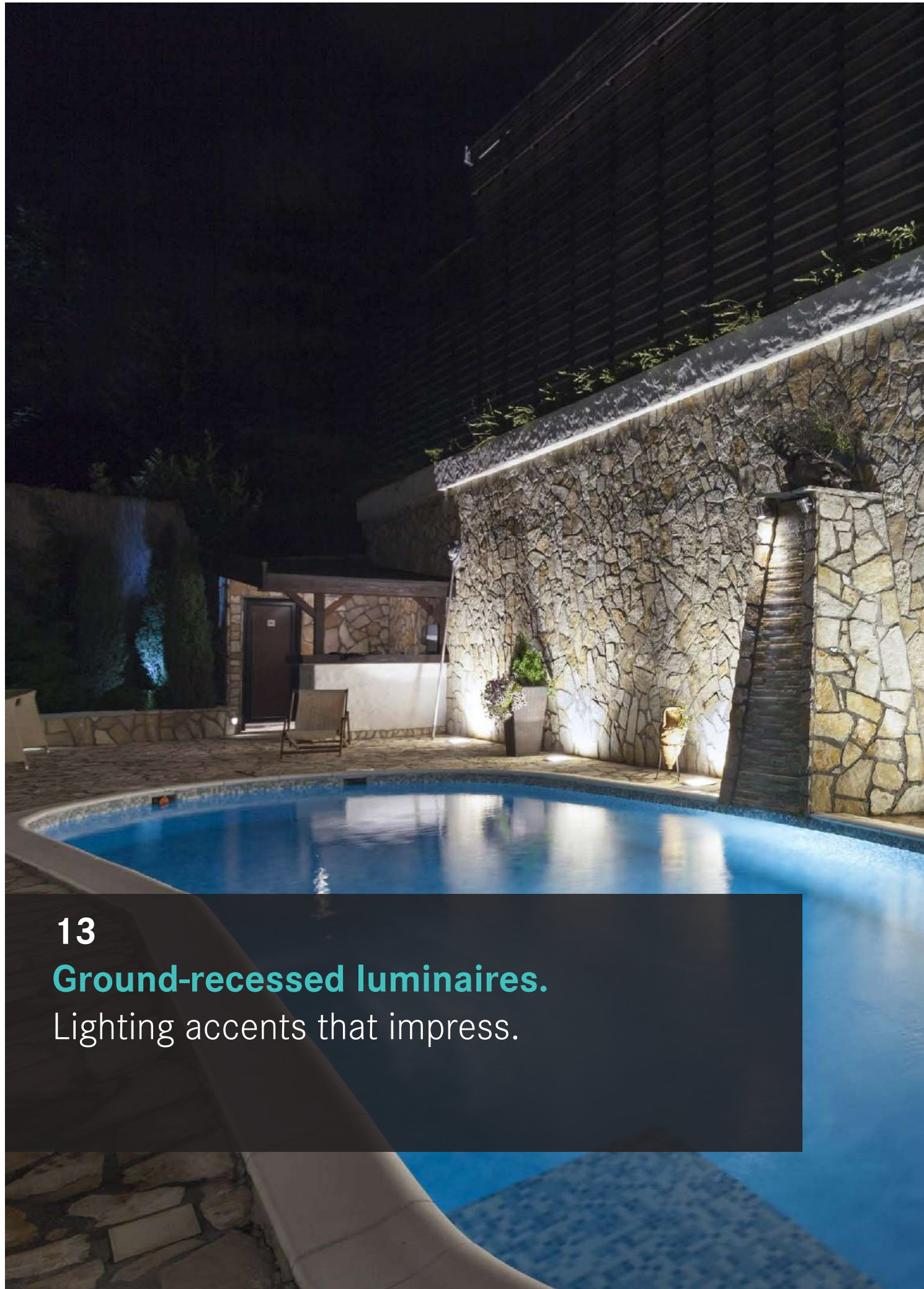

13

Ground-recessed luminaires.

Lighting accents that impress.

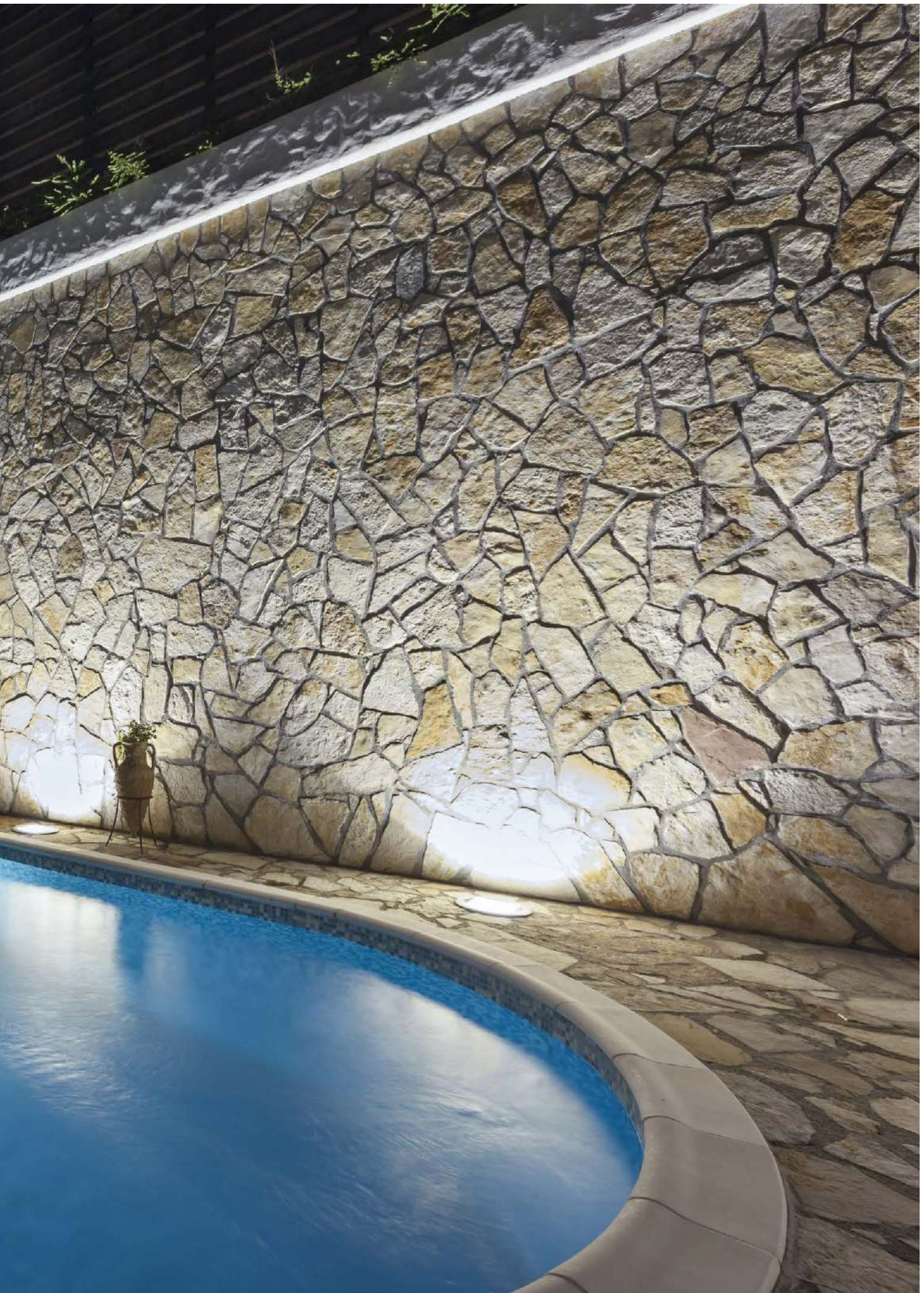

LANKA.

Adjustable lighting
for ceiling and floor.



For ceiling
and floor
installation



Ceiling-recessed bracket



Setting of the beam angle.

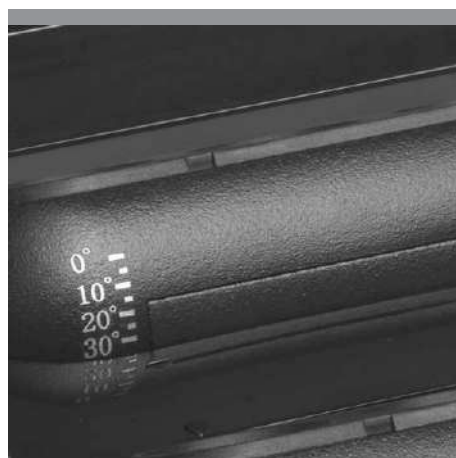

Beam angle from 0° to maximum 30°
in both directions.

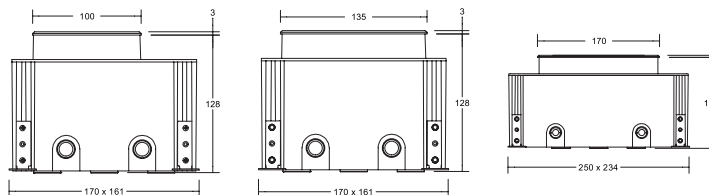

LANKA-R LED ground-recessed luminaire, V4A, IP67, switchable NEW

Lamp: LED, colour rendering: CRI > 80, beam angle: 30°, material: stainless steel / aluminium / glass, includes converter for 230 V mains supply, switchable, swivelling up to 30° in both directions, includes ground installation pot and ceiling installation springs



| Article no. | Power | Colour | Lumin. flux | Colour temp. | Luminaire dimensions | Price in € |
|--|-------|-----------------|-------------|--------------|----------------------|------------|
| 14665223 NEW | 4 W | stainless steel | 460 lm | 3,000 K | Ø 100 mm | 249.90 |
| 14666223 NEW | 8 W | stainless steel | 920 lm | 3,000 K | Ø 135 mm | 389.90 |
| 14667223 NEW | 12 W | stainless steel | 1,390 lm | 3,000 K | Ø 170 mm | 479.90 |

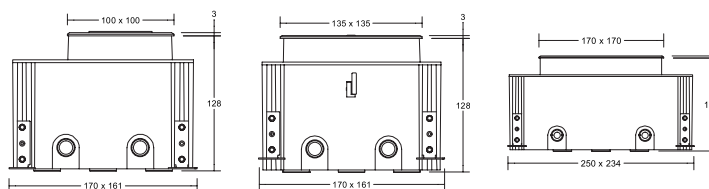
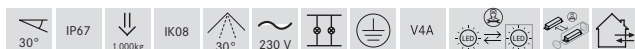

LANKA-S LED ground-recessed luminaire, V4A, IP67, switchable NEW

Lamp: LED, colour rendering: CRI > 80, beam angle: 30°, material: stainless steel / aluminium / glass, includes converter for 230 V mains supply, switchable, swivelling up to 30° in both directions, includes ground installation pot and ceiling installation springs



| Article no. | Power | Colour | Lumin. flux | Colour temp. | Luminaire dimensions | Price in € |
|--|-------|-----------------|-------------|--------------|----------------------|------------|
| 14674223 NEW | 4 W | stainless steel | 460 lm | 3,000 K | 100 mm x 100 mm | 259.90 |
| 14675223 NEW | 8 W | stainless steel | 920 lm | 3,000 K | 135 mm x 135 mm | 399.90 |
| 14676223 NEW | 12 W | stainless steel | 1,390 lm | 3,000 K | 170 mm x 170 mm | 489.90 |

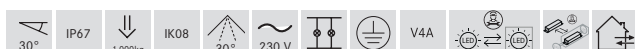

LANKO.

Elegant ground lighting
for pathways and large areas.

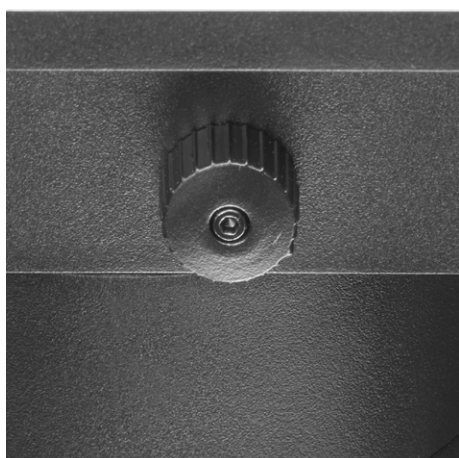
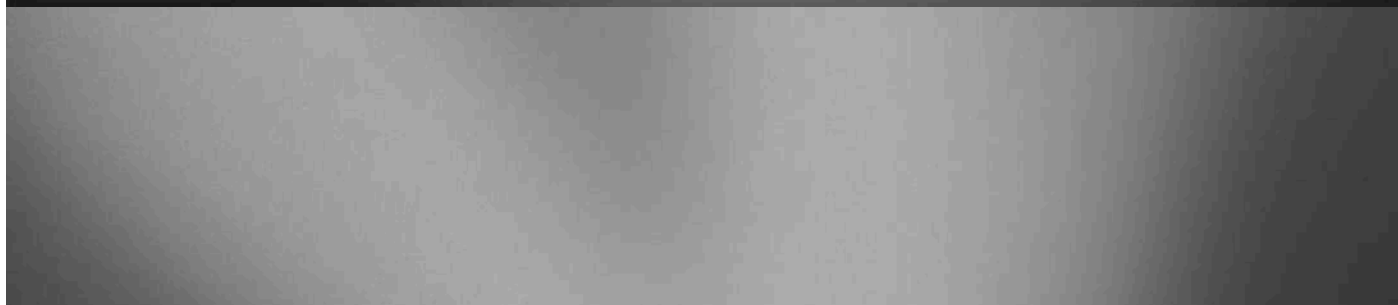

Setting of the beam angle.

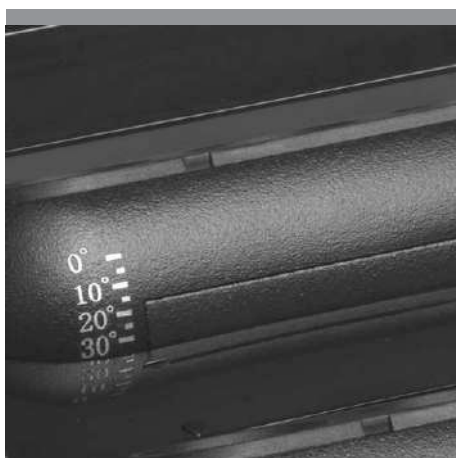

Beam angle from 0° to maximum 30°
in both directions.

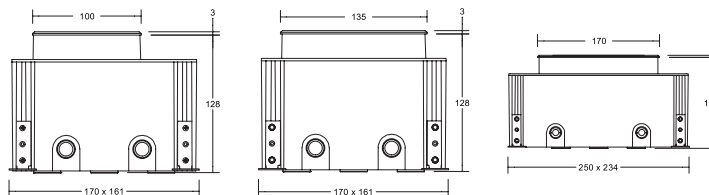

LANKO-R LED ground-recessed luminaire, V4A, IP67, switchable NEW

Lamp: LED, colour rendering: CRI > 80, beam angle: 30°, includes converter for 230 V mains supply, switchable, swivelling up to 30° in both directions, ground installation pot



| Article no. | Power | Colour | Lumin. flux | Colour temp. | Luminaire dimensions | Price in € |
|-------------|--|--------|-------------|--------------|----------------------|------------|
| 14685083 | NEW 4 W | black | 460 lm | 3,000 K | Ø 100 mm | 219.90 |
| 14686083 | NEW 8 W | black | 920 lm | 3,000 K | Ø 135 mm | 359.90 |
| 14687083 | NEW 12 W | black | 1,390 lm | 3,000 K | Ø 170 mm | 449.90 |

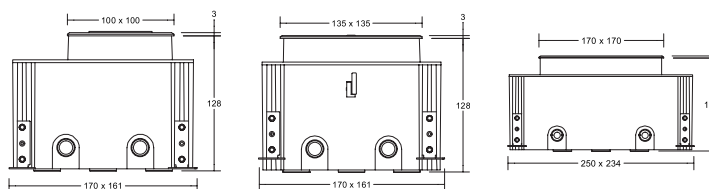
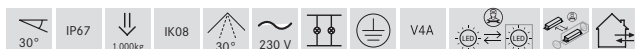

LANKO-S LED ground-recessed luminaire, V4A, IP67, switchable NEW

Lamp: LED, colour rendering: CRI > 80, beam angle: 30°, includes converter for 230 V mains supply, switchable, swivelling up to 30° in both directions, ground installation pot



| Article no. | Power | Colour | Lumin. flux | Colour temp. | Luminaire dimensions | Price in € |
|-------------|--|--------|-------------|--------------|----------------------|------------|
| 14694083 | NEW 4 W | black | 460 lm | 3,000 K | 100 mm x 100 mm | 229.90 |
| 14695083 | NEW 8 W | black | 920 lm | 3,000 K | 135 mm x 135 mm | 369.90 |
| 14696083 | NEW 12 W | black | 1,390 lm | 3,000 K | 170 mm x 170 mm | 459.90 |

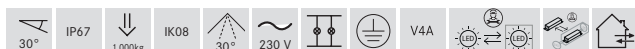

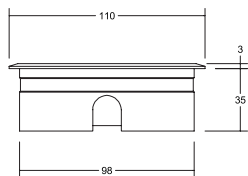

Art. no. 14037223

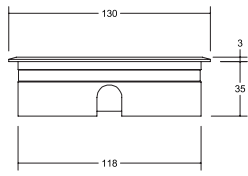

Art. no. 14035223

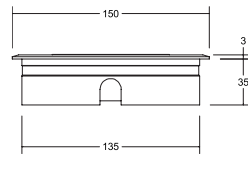

Art. no. 14036223

HYBRIDE FLAT LED ceiling / ground-recessed luminaire, V4A, IP67, switchable

Lamp: LED, colour rendering: CRI > 80, material: stainless steel / aluminium / glass, includes 1,000 mm connecting cable with Aquastop and ceiling installation springs

You can find the corresponding 24 V converter from page 262 onwards.

| Article no. | Colour | Lumin. flux | Power | Colour temp. | Beam angle | Price in € |
|-------------|---------------|-------------|-------|--------------|------------|------------|
| 14037223 | stainl. steel | 420 lm | 6 W | 3,000 K | 20° | 190.90 |
| 14035223 | stainl. steel | 450 lm | 9 W | 3,000 K | 30° | 222.90 |
| 14036223 | stainl. steel | 890 lm | 12 W | 3,000 K | 30° | 279.90 |

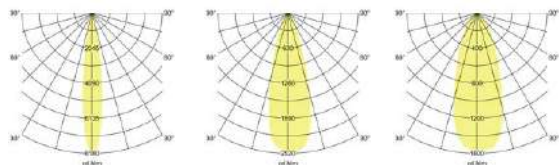

Art. no. 14037223

Art. no. 14035223

Art. no. 14036223

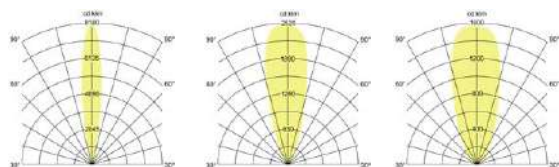

HYBRIDE FLAT is only available as a switchable version.

These items are subject to discount group 1.



Recessed ceiling versions



Recessed ground versions

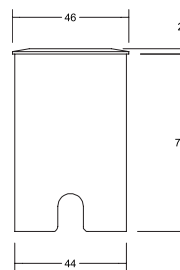

HYBRIDE MINI LED ground-recessed luminaire, V4A, IP65, switchable

Lamp: LED, colour rendering: CRI > 80, power: 1.4 W, beam angle: 100°, material: stainless steel / aluminium / glass, includes 3,000 mm connecting cable.

You can find the corresponding 24 V converter from page 262 onwards.

| Article no. | Colour | Colour temp. | Price in € |
|-------------|-----------------|--------------|------------|
| 14050223 | stainless steel | 3,000 K | 132.90 |
| 14051223 | stainless steel | 3,000 K | 134.90 |



These items are subject to discount group 1.



Robust and durable thanks to V4A, IP67 and Aquastop.

BOLED.

Robust recessed spotlight in
three power classes.

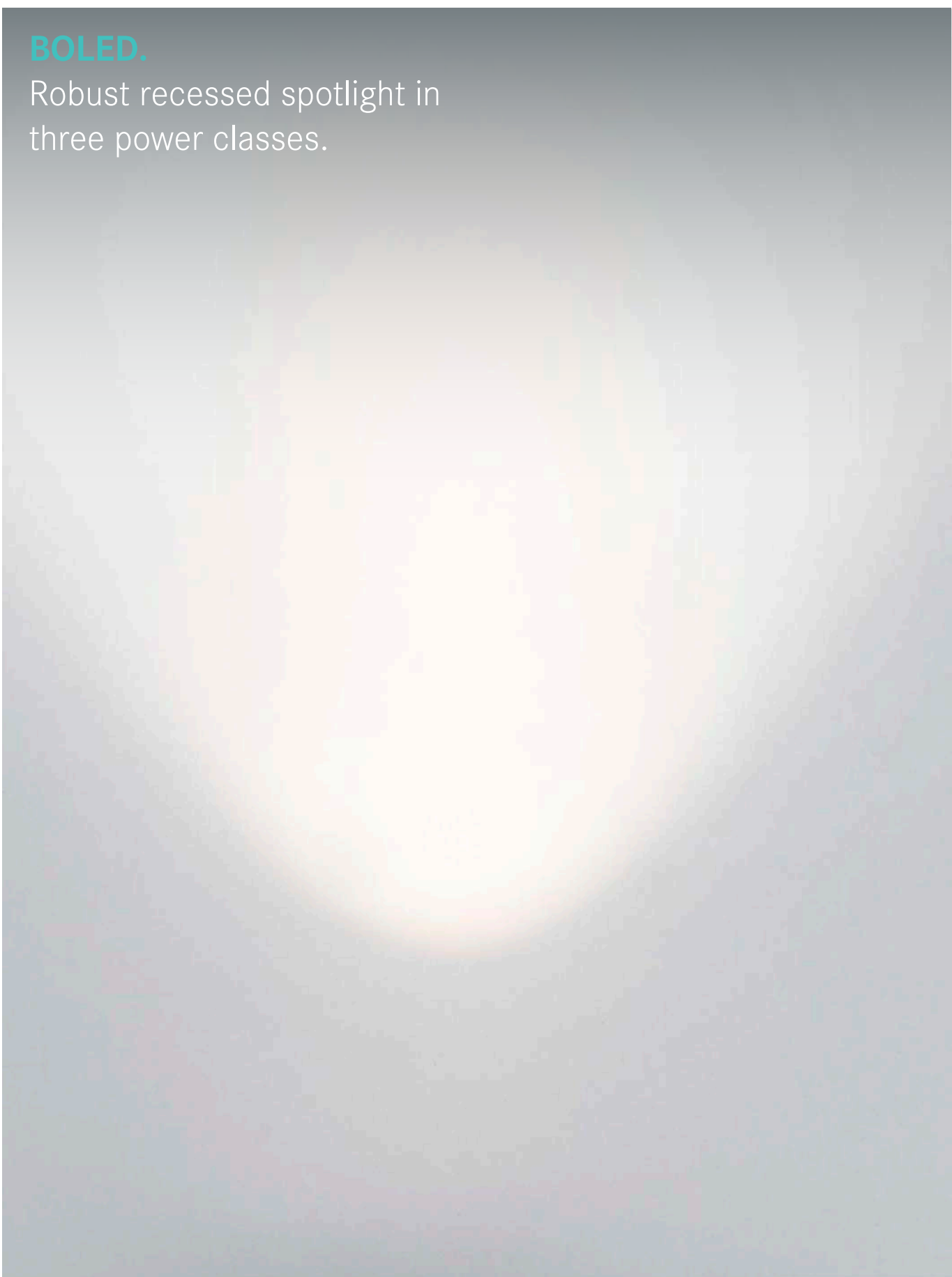

IP67



IP67 has complete protection against accidental contact. Dust cannot penetrate and the fitting is protected against immersion for up to 30 minutes.

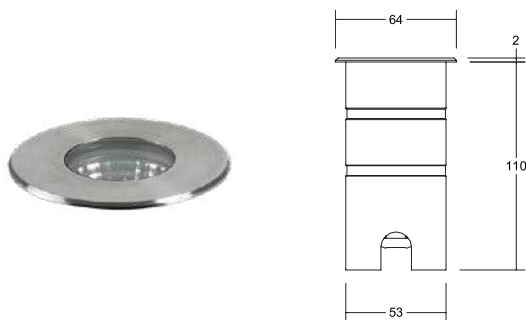

BOLED LED ground-recessed luminaire, V4A, IP67, switchable

Lamp: LED, colour rendering: CRI > 80, power: 6 W, beam angle: 36°, material: V4A stainless steel / aluminium / glass, includes converter for connection to 230 V mains supply, switchable and 1,000 mm connecting cable with Aquastop

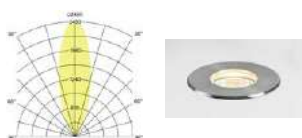

| Article no. | Colour | Luminous flux | Colour temp. | Price in € |
|-------------|-----------------|---------------|--------------|------------|
| 14052223 | stainless steel | 485 lm | 3,000 K | 217.90 |

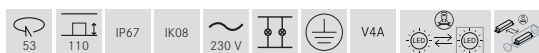

This item is subject to discount group 1.

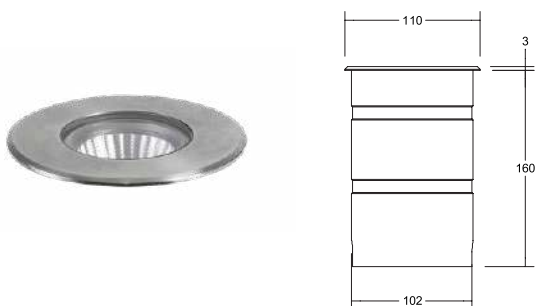

BOLED LED ground-recessed luminaire, V4A, IP67, switchable

Lamp: LED, colour rendering: CRI > 80, power: 12 W, beam angle: 38°, material: V4A stainless steel / aluminium / glass, includes converter for connection to 230 V mains voltage, switchable and 1,000 mm connecting cable with Aquastop

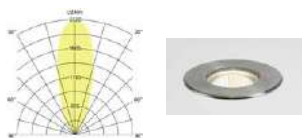

| Article no. | Colour | Luminous flux | Colour temp. | Price in € |
|-------------|-----------------|---------------|--------------|------------|
| 14053223 | stainless steel | 1,050 lm | 3,000 K | 299.90 |

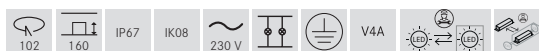

This item is subject to discount group 1.



BOLED LED ground-recessed luminaire, V4A, IP67, switchable

Lamp: LED, colour rendering: CRI > 80, power: 15 W, beam angle: 38°, material: V4A stainless steel / aluminium / glass, includes converter for connection to 230 V mains voltage, switchable and 1,000 mm connecting cable with Aquastop

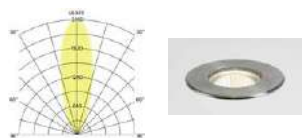

| Article no. | Colour | Luminous flux | Colour temp. | Price in € |
|-------------|-----------------|---------------|--------------|------------|
| 14054223 | stainless steel | 1,320 lm | 3,000 K | 309.90 |

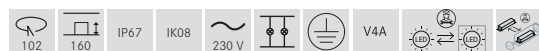

This item is subject to discount group 1.



LED ground-recessed luminaire, IP67, switchable

Lamp: LED, colour rendering: CRI > 80, power: 0.15 W, material: stainless steel / aluminium / glass, includes 5,000 mm connection cable



| Article no. | Colour | Colour temp. | Price in € |
|-------------|-----------------|--------------|------------|
| 14011223 | stainless steel | 3,000 K | 64.90 |

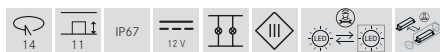

This item is subject to discount group 1.



LED ground-recessed luminaire, IP65, switchable

Includes installation sleeve and 150 mm connecting cable.

Lamp: LED, version: Plug&Play, power: 1 W, material: stainless steel / aluminium / plastic / glass

| Article no. | Colour | Luminous flux | Colour temp. | Price in € |
|-------------|-----------------|---------------|--------------|------------|
| P3817WW | stainless steel | 40 lm | 3,000 K | 148.30 |

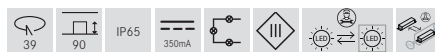

This item is subject to discount group 1.

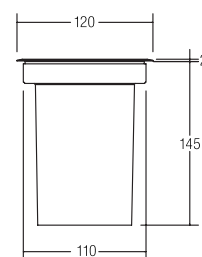

Ground-recessed luminaire, IP65, GU10

Lamp: for LED retrofit lamp, lamp holder: GU10,
power: max. 5 W, material: stainless steel / glass

Suitable for Megaman LED lamp MM 27432 / MM 26302
(not included in scope of supply).

| Article no. | Colour | Price in € |
|-------------|-----------------|------------|
| 3105 | stainless steel | 109.90 |



This item is subject to discount group 1.

NIAS.

Decorative lighting accents
for light lines and corners.



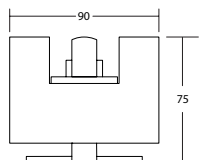

NIAS LED ground-mounted luminaire, IP65, NEW switchable

Lamp: LED, colour rendering: CRI > 80, power: 3 W, beam angle: 3°, material: aluminium, includes converter for connection to 230 V mains supply, switchable



| Article no. | Colour | Lumin. flux | Colour temp. | Price in € |
|-------------|---|-------------|--------------|------------|
| 60122103 | NEW textured graphite | 288 lm | 3,000 K | 399.90 |



These items are subject to discount group 1.

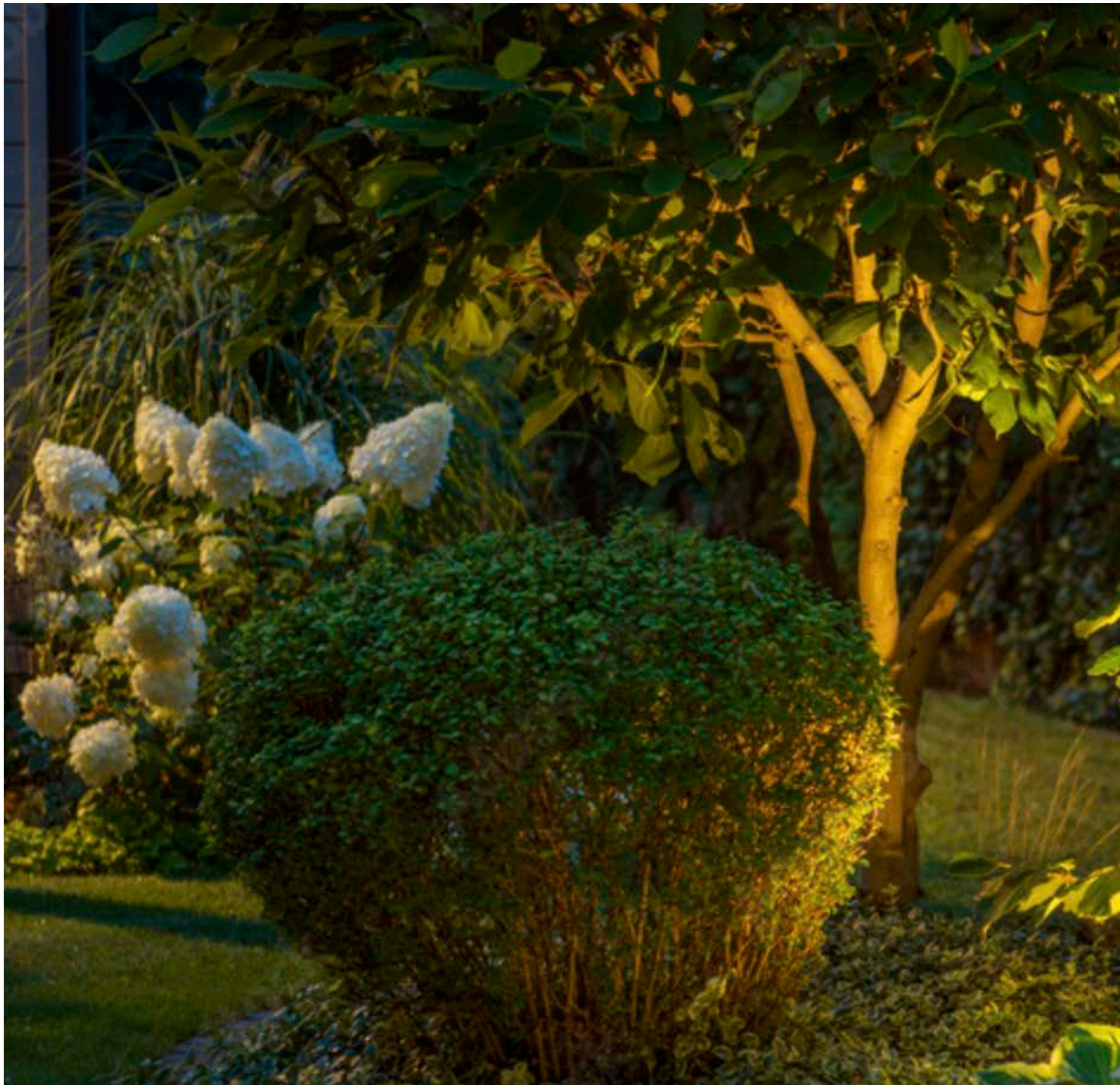

14

Ground spike luminaires.

Targeted outdoor lighting.



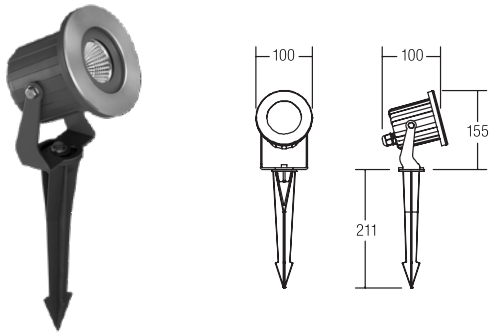

STIRIUS LED ground spike spotlight, 230 V AC, IP65, switchable

Lamp: LED, colour rendering: CRI > 80, power: 6 W, beam angle: 40°, material: stainless steel / aluminium / glass, includes converter for 230 V mains supply, switchable and 2,000 mm connecting cable and plug

| Article no. | Colour | Lumin. flux | Colour temp. | Price in € |
|-------------|----------------------------------|-------------|--------------|------------|
| 60103223 | textured black / stainless steel | 450 lm | 3,000 K | 239.90 |

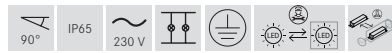

This item is subject to discount group 1.

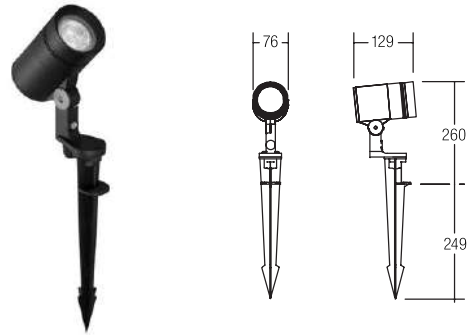

TRIVIA LED ground spike spotlight, 230 V AC, IP65, switchable

Lamp: LED, colour rendering: CRI > 80, power: 8 W, beam angle: 30°, material: aluminium / glass, includes converter for connection to 230 V mains supply, switchable, 2,000 mm connecting cable and plug

| Article no. | Colour | Lumin. flux | Colour temp. | Price in € |
|-------------|----------------|-------------|--------------|------------|
| 60104183 | textured black | 600 lm | 3,000 K | 319.90 |

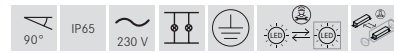

This item is subject to discount group 1.

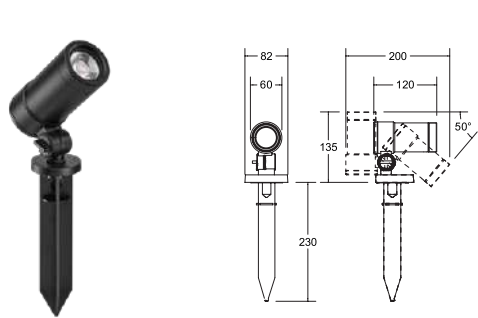

KARAKOL LED ground spike spotlight, 230 V AC, IP66, switchable

Lamp: LED, colour rendering: CRI > 80, power: 7.4 W, material: aluminium / glass, includes converter for 230 V mains supply, switchable and 2,000 mm connecting cable and plug



KARAKOL LED ground spike spotlight, 230 V AC, IP66, switchable

Lamp: LED, colour rendering: CRI > 80, power: 12.3 W, material: aluminium / glass, includes converter for 230 V mains supply, switchable and 2,000 mm connecting cable and plug

| Article no. | Colour | Lumin. flux | Colour temp. | Price in € |
|-------------|----------------|-------------|--------------|------------|
| 60117183 | textured black | 660 lm | 3,000 K | 219.90 |

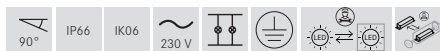

This item is subject to discount group 1.

| Article no. | Colour | Lumin. flux | Colour temp. | Price in € |
|-------------|----------------|-------------|--------------|------------|
| 60118183 | textured black | 1,300 lm | 3,000 K | 239.90 |

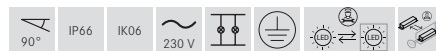

This item is subject to discount group 1.

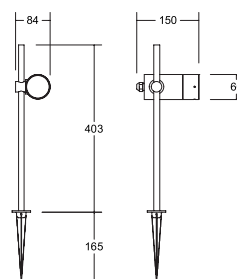

ASTERIA LED ground spike spotlight, 230 V AC, IP65

Lamp: LED, colour rendering: CRI > 90, power: 8.5 W, beam angle: 21°, material: aluminium / glass, includes converter for 230 V mains supply and 1,500 mm connecting cable, switchable, height-adjustable luminaire head

| Article no. | Colour | Luminous flux | Colour temp. | Price in € |
|-------------|----------------|---------------|--------------|------------|
| 60113183 | textured black | 500 lm | 3,000 K | 229.90 |



This item is subject to discount group 1.

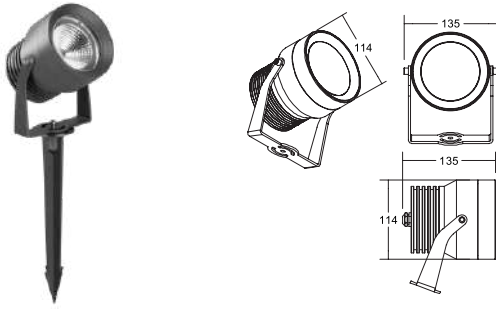

LEGRA LED ground spike spotlight, 230 V AC, IP65, switchable NEW

Lamp: LED, colour rendering: CRI > 80, power: 20 W, material: aluminium / glass, includes converter for 230 V mains supply, switchable, 2,000 mm connecting cable and plug

| Article no. | Colour | Lumin. flux | Colour temp. | Price in € |
|-------------|---|-------------|--------------|------------|
| 65271103 | NEW textured graphite | 1,130 lm | 3,000 K | 234.00 |



This item is subject to discount group 1.

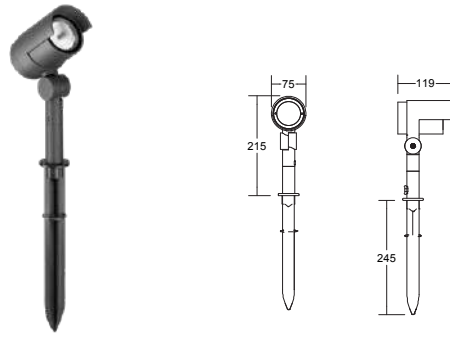

LEGRA LED ground spike spotlight, 230 V AC, IP65, switchable NEW

Lamp: LED, colour rendering: CRI > 80, power: 15 W, material: aluminium / glass, includes converter for connection to 230 V mains supply, switchable, with connection box

| Article no. | Colour | Lumin. flux | Colour temp. | Price in € |
|-------------|---|-------------|--------------|------------|
| 65272103 | NEW textured graphite | 830 lm | 3,000 K | 216.30 |



This item is subject to discount group 1.



LEGRA.

Optimal staging
of planting.



IP65

IP65 has complete protection against accidental contact. Dust cannot penetrate and it is protected against jets of water in any direction.

VITI.

Green spaces
decoratively staged.

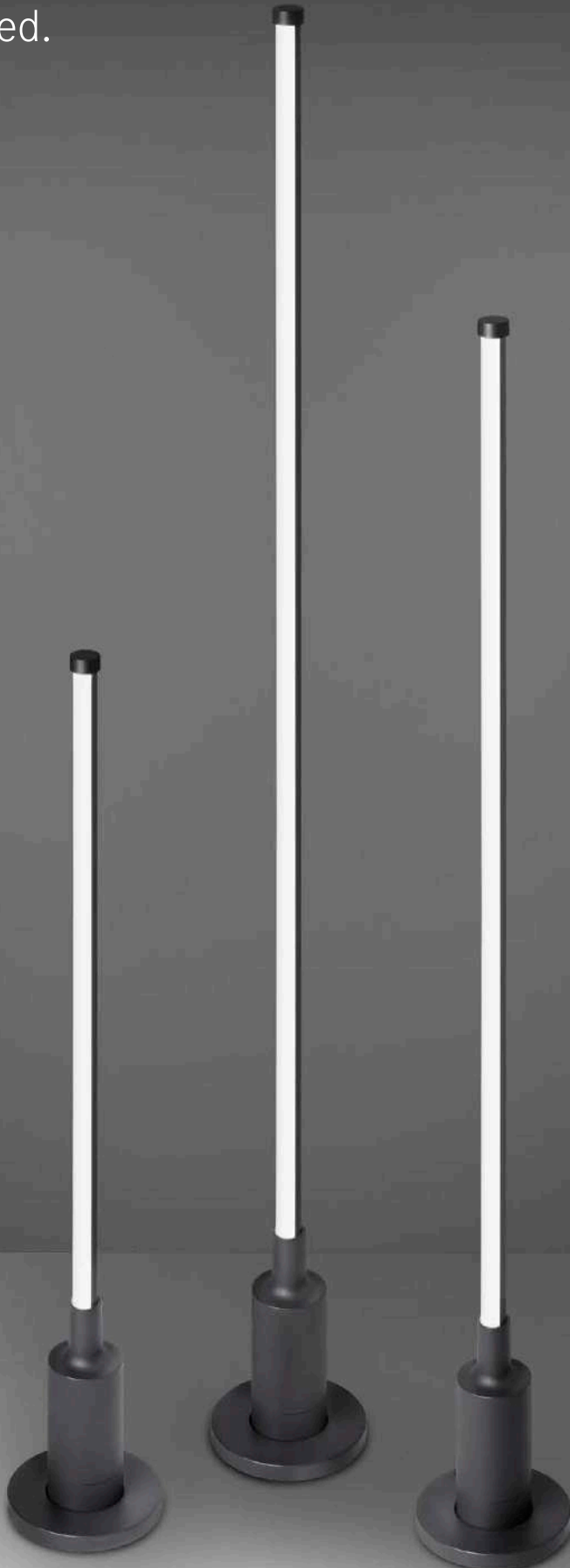

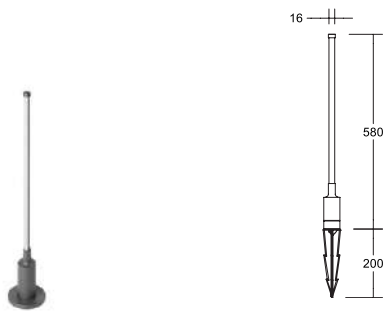

VITI LED ground spike spotlight, 230 V AC, IP65, switchable NEW

Lamp: LED, colour rendering: CRI > 90, power: 6 W, beam angle: 120°, material: aluminium / plastic, includes converter for connection to 230 V mains supply, switchable

| Article no. | Colour | Lumin. flux | Colour temp. | Price in € |
|-------------|--|-------------|--------------|------------|
| 60020103 | NEW textured graphite | 516 lm | 3,000 K | 99.90 |

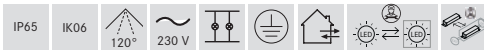

These items are subject to discount group 1.

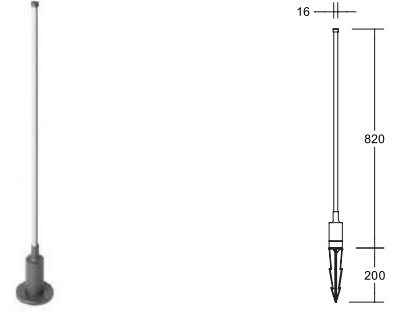

VITI LED ground spike spotlight, 230 V AC, IP65, switchable NEW

Lamp: LED, colour rendering: CRI > 90, power: 10 W, beam angle: 120°, material: aluminium / plastic, includes converter for connection to 230 V mains supply, switchable

| Article no. | Colour | Lumin. flux | Colour temp. | Price in € |
|-------------|--|-------------|--------------|------------|
| 60021103 | NEW textured graphite | 743 lm | 3,000 K | 119.90 |

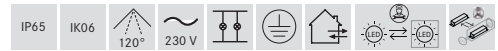

These items are subject to discount group 1.

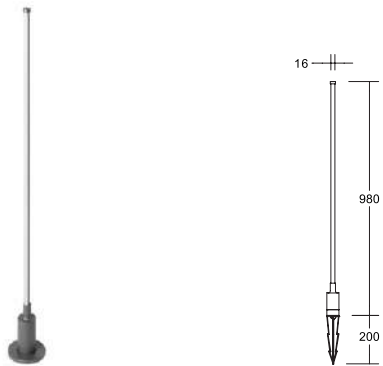

VITI LED ground spike spotlight, 230 V AC, IP65, switchable NEW

Lamp: LED, colour rendering: CRI > 90, power: 12 W, beam angle: 120°, material: aluminium / plastic, includes converter for connection to 230 V mains supply, switchable

| Article no. | Colour | Lumin. flux | Colour temp. | Price in € |
|-------------|--|-------------|--------------|------------|
| 60022103 | NEW textured graphite | 795 lm | 3,000 K | 139.90 |

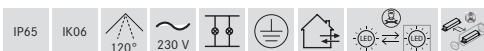

These items are subject to discount group 1.

Installation with ground spike or as ground mounting.



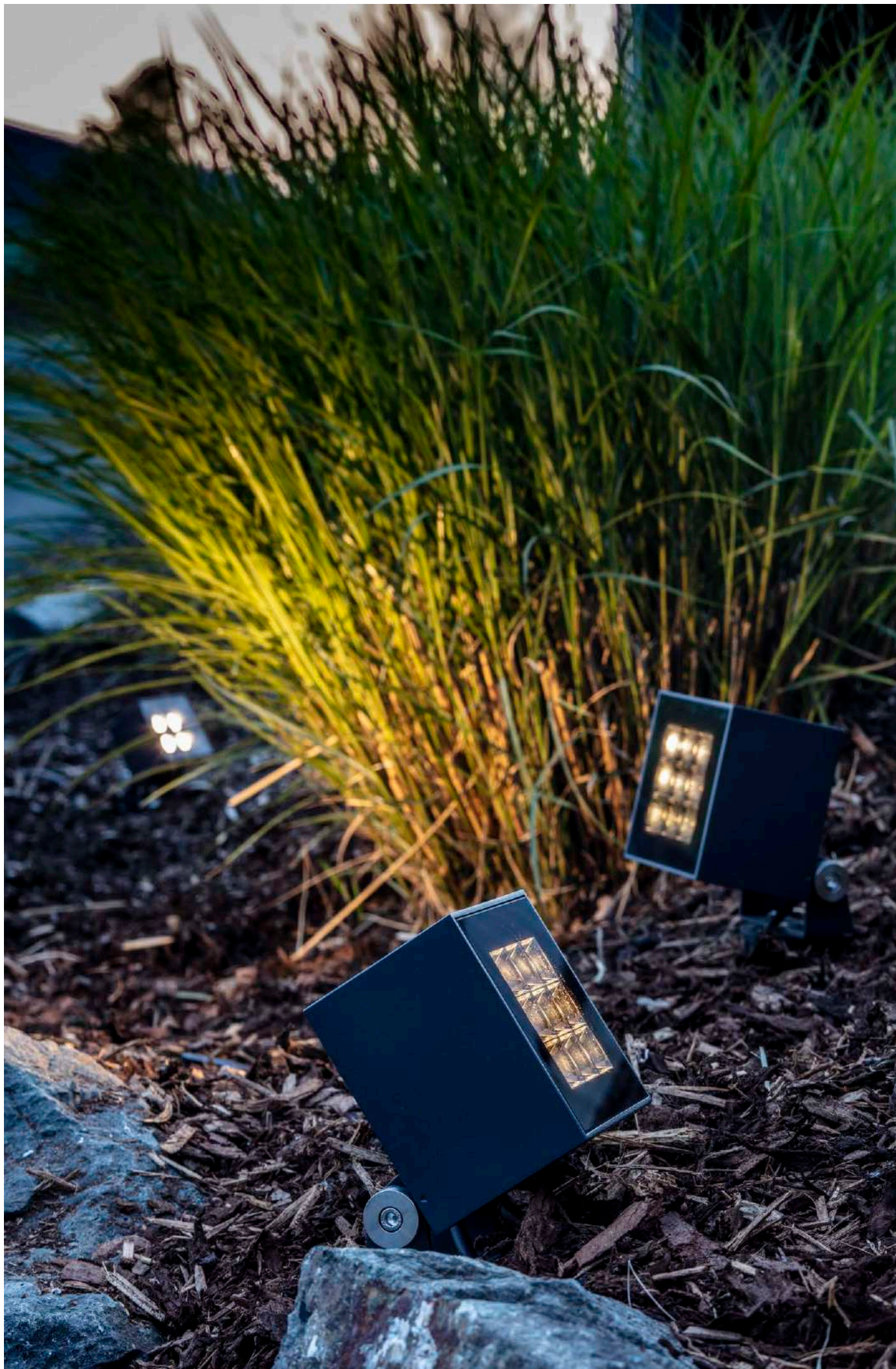

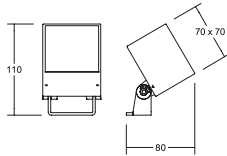

BLOKK LED surface-mounted spotlight, IP65, switchable

Lamp: LED, colour rendering: CRI > 80, power: 10 W, beam angle: 34°, material: aluminium / glass, includes converter for 230 V mains supply, switchable, 2,000 mm connecting cable

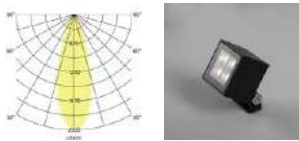

| Article no. | Colour | Luminous flux | Colour temp. | Price in € |
|-------------|-------------------|---------------|--------------|------------|
| 60111103 | textured graphite | 635 lm | 3,000 K | 259.90 |



This item is subject to discount group 1.

Optional accessories:



Ground spike
Art. no. 81017000
Price: 7.60 €

Product family BLOKK



BLOKK ceiling-mounted luminaire
Article no.: 60115103

see page 311

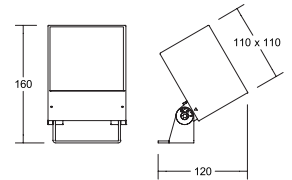

BLOKK LED surface-mounted spotlight, IP65, switchable

Lamp: LED, colour rendering: CRI > 80, power: 22 W, beam angle: 32°, material: aluminium / glass, includes converter for 230 V mains supply, switchable, 2,000 mm connecting cable



| Article no. | Colour | Luminous flux | Colour temp. | Price in € |
|-------------|-------------------|---------------|--------------|------------|
| 60112103 | textured graphite | 1,600 lm | 3,000 K | 439.90 |

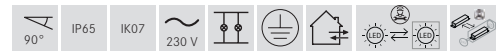

This item is subject to discount group 1.

Optional accessories:



Ground spike
Art. no. 81021000
Price: 12.80 €



Ground anchor for concrete fixing
Art. no. 81023000
Price: 28.50 €



Mounting strap, length: 2,000 mm
Art. no.: 81022000
Price: 76.90 €

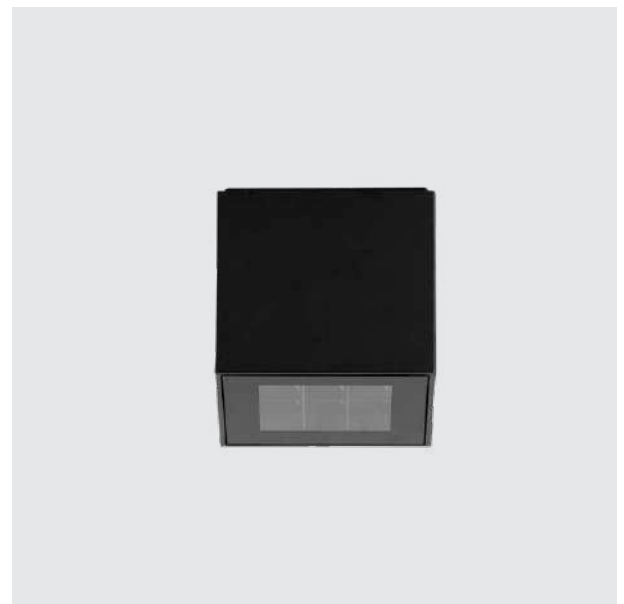

BLOKK ceiling-mounted luminaire
Article no.: 60116103

see page 311



15

Bollard luminaires.

Lighting of paths and steps.



STICK.

Modular LED bollard luminaires.

Even lighting for
gardens and paths.

Switchable colour
temperature
3,000 K or 4,000 K



IP65
IK08

IP65 has complete protection against accidental contact. Dust cannot penetrate and it is protected against jets of water in any direction.

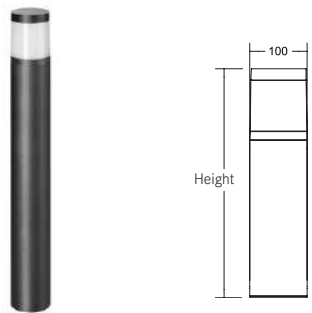

STICK LED bollard luminaire, IP65, switchable

Lamp: LED, colour rendering: CRI > 80, power: 8 W, beam angle: 120°, material: aluminium / plastic, includes converter for connection to 230 V mains voltage, includes cable connector, switchable

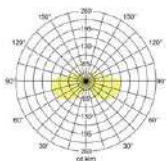

STICK LED wall-mounted luminaire see page 323



| Article no. | Colour | Height | Lumin. flux | Colour temperature | Price in € |
|-------------|----------------|----------|-------------|--------------------|------------|
| 60019183 | textured black | 400 mm | 530 lm | 3,000 K / 4,000 K | 189.90 |
| 60029183 | textured black | 750 mm | 530 lm | 3,000 K / 4,000 K | 229.90 |
| 60039183 | textured black | 1,000 mm | 530 lm | 3,000 K / 4,000 K | 269.90 |



These items are subject to discount group 1.

LEVU.

Rectilinear design
for entrance areas.

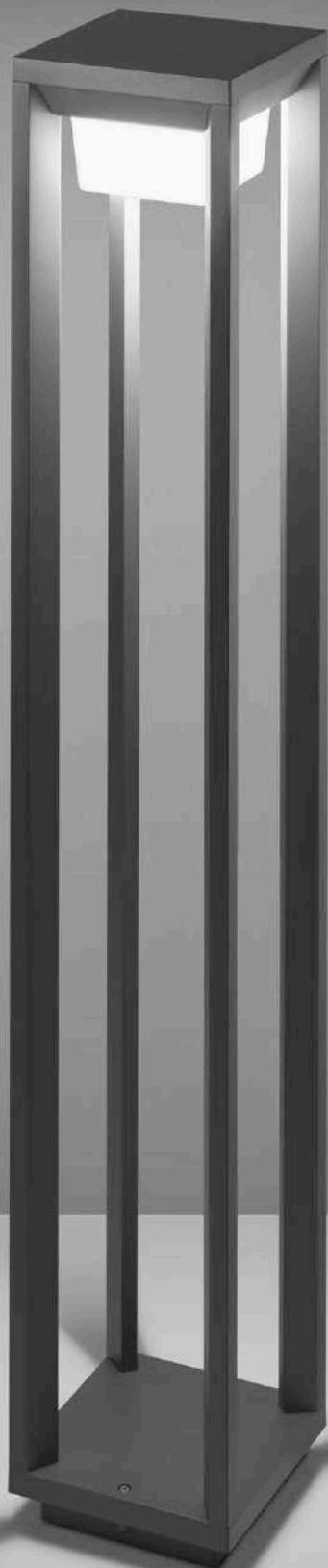

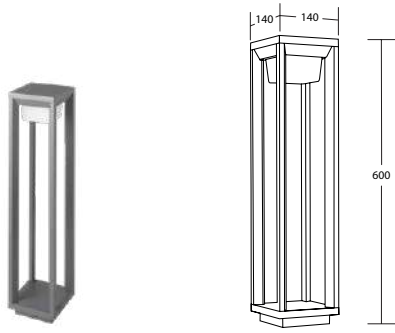

**LEVU LED bollard luminaire, IP54,
height: 600 mm, switchable**

NEW

Lamp: LED, colour rendering: CRI > 80, power: 6.6 W, material: die-cast aluminium / plastic, includes converter for connection to 230 V mains supply, switchable

| Article no. | Colour | Lumin. flux | Colour temp. | Price in € |
|-------------|------------------------------|-------------|--------------|------------|
| 65382103 | NEW textured graphite | 420 lm | 3,000 K | 159.90 |



These items are subject to discount group 1.

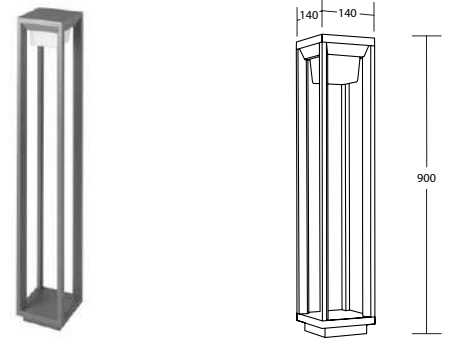

**LEVU LED bollard luminaire, IP54,
height: 900 mm, switchable**

NEW

Lamp: LED, colour rendering: CRI > 80, power: 6.6 W, material: die-cast aluminium / plastic, includes converter for connection to 230 V mains supply, switchable

| Article no. | Colour | Lumin. flux | Colour temp. | Price in € |
|-------------|------------------------------|-------------|--------------|------------|
| 65383103 | NEW textured graphite | 420 lm | 3,000 K | 179.90 |



These items are subject to discount group 1.

LEVU wall luminaire
see page 335

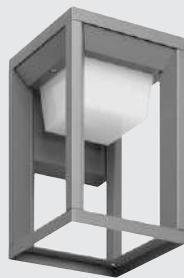

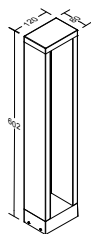

ADDIA LED bollard luminaire, IP54, height 600 mm, switchable

Lamp: LED, colour rendering: CRI > 80, power: 10 W, beam angle: 120°, material: aluminium / glass, includes converter for connection to 230 V mains supply, switchable



| Article no. | Colour | Lumin. flux | Colour temp. | Price in € |
|-------------|-------------------|-------------|--------------|------------|
| 65261103 | textured graphite | 400 lm | 3,000 K | 230.40 |



This item is subject to discount group 1.

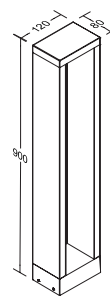

ADDIA LED bollard luminaire, IP54, height 900 mm, switchable

Lamp: LED, colour rendering: CRI > 80, power: 10 W, beam angle: 120°, material: aluminium / glass, includes converter for connection to 230 V mains supply, switchable



| Article no. | Colour | Lumin. flux | Colour temp. | Price in € |
|-------------|-------------------|-------------|--------------|------------|
| 65262103 | textured graphite | 435 lm | 3,000 K | 250.60 |



This item is subject to discount group 1.



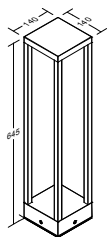

ABEE LED bollard luminaire, IP54, height 650 mm, switchable

Lamp: LED, colour rendering: CRI > 80, power: 15 W, beam angle: 120°, material: aluminium / glass, includes converter for connection to 230 V mains supply, switchable



| Article no. | Colour | Lumin. flux | Colour temp. | Price in € |
|-------------|-------------------|-------------|--------------|------------|
| 65263103 | textured graphite | 935 lm | 3,000 K | 253.00 |



This item is subject to discount group 1.



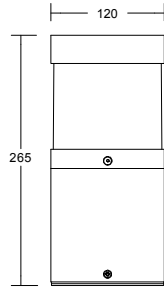

ZAGAMI LED bollard luminaire, IP54, height 265 mm, switchable

Lamp: LED, colour rendering: CRI > 80, power: 13 W, material: aluminium / glass, includes converter for connection to 230 V mains supply, switchable



| Article no. | Colour | Lumin. flux | Colour temp. | Price in € |
|-------------|-------------------|-------------|--------------|------------|
| 65181103 | textured graphite | 560 lm | 3,000 K | 230.90 |



This item is subject to discount group 1.

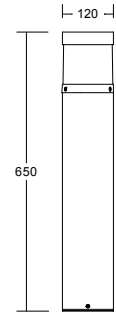

ZAGAMI LED bollard luminaire, IP54, height 650 mm, switchable

Lamp: LED, colour rendering: CRI > 80, power: 13 W, material: aluminium / glass, includes converter for connection to 230 V mains supply, switchable



| Article no. | Colour | Lumin. flux | Colour temp. | Price in € |
|-------------|-------------------|-------------|--------------|------------|
| 65182103 | textured graphite | 368 lm | 3,000 K | 263.00 |



This item is subject to discount group 1.



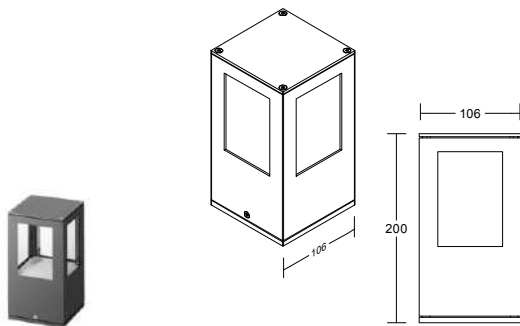

KORRA LED bollard luminaire, IP54, height 200 mm, switchable

Lamp: LED, colour rendering: CRI > 80, power: 7 W, material: aluminium / glass, includes converter for connection to 230 V mains supply, switchable



| Article no. | Colour | Lumin. flux | Colour temp. | Price in € |
|-------------|-------------------|-------------|--------------|------------|
| 65191103 | textured graphite | 250 lm | 3,000 K | 201.30 |



This item is subject to discount group 1.

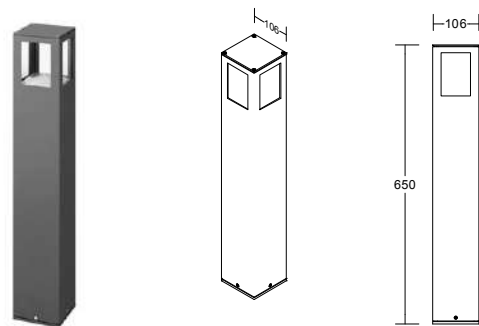

KORRA LED bollard luminaire, IP54, height 650 mm, switchable

Lamp: LED, colour rendering: CRI > 80, power: 7 W, material: aluminium / glass, includes converter for connection to 230 V mains supply, switchable



| Article no. | Colour | Lumin. flux | Colour temp. | Price in € |
|-------------|-------------------|-------------|--------------|------------|
| 65192103 | textured graphite | 600 lm | 3,000 K | 252.20 |



This item is subject to discount group 1.



MADURA.

Functional beauty
for paths and façades.



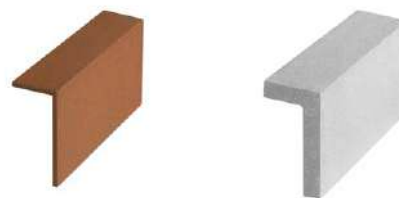
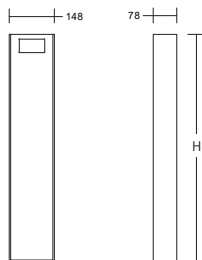

MADURA bollard housing for MADURA wall-mounted luminaire 60119103

NEW

Base dimensions: L 148 x W 77.5 mm

Material: aluminium

| Article no. | Colour | Height | Price in € |
|-------------|-----------------------|----------|------------|
| 81440180 | NEW textured graphite | 400 mm | 199.90 |
| 81475180 | NEW textured graphite | 750 mm | 249.90 |
| 81410180 | NEW textured graphite | 1,000 mm | 299.90 |

MADURA Cover for MADURA wall-mounted luminaire 60119103

NEW

Optional accessories:

Cover for modifying the luminaire, dimensions: L x W x H: 140 x 33 x 70 mm, material: aluminium or concrete

| Article no. | Colour | Description | Price in € |
|-------------|--------------|--------------------|------------|
| 81401120 | NEW rust | Cover for 60119... | 29.90 |
| 81401730 | NEW concrete | Cover for 60119... | 39.90 |



MADURA wall luminaire
see page 339



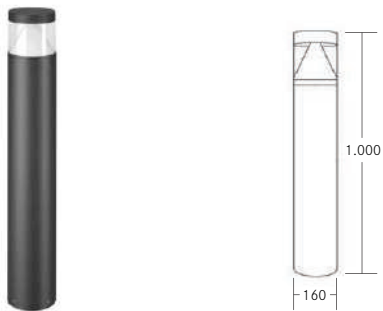

MEDUSA LED bollard luminaire, IP54, height 1,000 mm, switchable

Lamp: LED, colour rendering: CRI > 80, power: 18 W, material: aluminium / polycarbonate, includes converter for connection to 230 V mains supply, switchable



| Article no. | Colour | Lumin. flux | Colour temp. | Price in € |
|-------------|-------------------|-------------|--------------|------------|
| 65212103 | textured graphite | 1,420 lm | 3,000 K | 422.00 |



This item is subject to discount group 1.

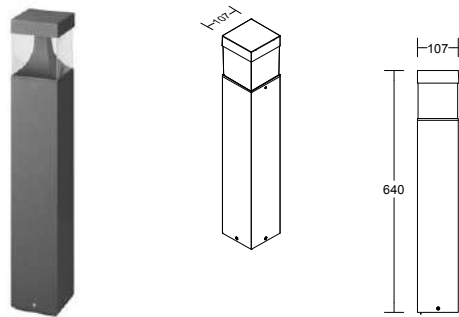

MEDUSA LED bollard luminaire, IP54, height 640 mm, switchable

Lamp: LED, colour rendering: CRI > 80, power: 9 W, material: aluminium / polycarbonate, includes converter for connection to 230 V mains supply, switchable



| Article no. | Colour | Lumin. flux | Colour temp. | Price in € |
|-------------|-------------------|-------------|--------------|------------|
| 65211103 | textured graphite | 365 lm | 3,000 K | 242.20 |



This item is subject to discount group 1.



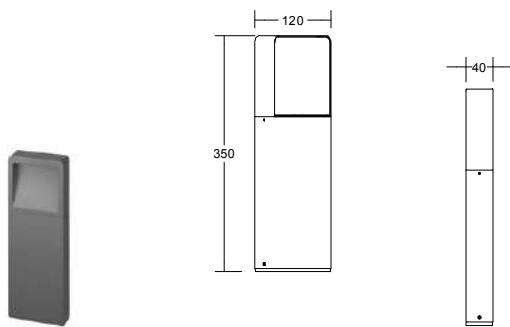

ILIA LED bollard luminaire, IP54, height 350 mm, switchable

Lamp: LED, colour rendering: CRI > 80, power: 6 W, material: aluminium / glass, includes converter for connection to 230 V mains supply, switchable



| Article no. | Colour | Lumin. flux | Colour temp. | Price in € |
|-------------|-------------------|-------------|--------------|------------|
| 65221103 | textured graphite | 180 lm | 3,000 K | 200.30 |



This item is subject to discount group 1.

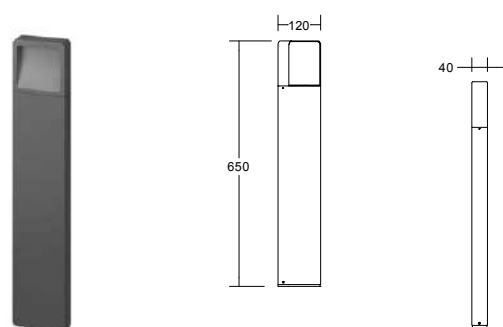

ILIA LED bollard luminaire, IP54, height 650 mm, switchable

Lamp: LED, colour rendering: CRI > 80, power: 7 W, material: aluminium / glass, includes converter for connection to 230 V mains supply, switchable



| Article no. | Colour | Lumin. flux | Colour temp. | Price in € |
|-------------|-------------------|-------------|--------------|------------|
| 65222103 | textured graphite | 243 lm | 3,000 K | 225.30 |



This item is subject to discount group 1.



APORIA.

Safe, efficient lighting
due to motion sensors.



IP54

IP54 has complete protection against accidental contact, while dust can penetrate in small quantities. In addition, it is protected against water splashing from any direction.

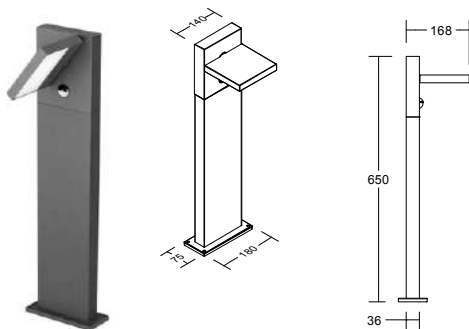

APORIA LED bollard luminaire, IP54, height 650 mm, switchable

Lamp: LED, colour rendering: CRI > 80, power: 14 W, material: aluminium / polycarbonate, 60° swivelling, includes converter for connection to 230 V mains supply, switchable

Motion sensor and twilight sensor:

Lighting time: adjustable from 5 seconds to 10 minutes, range: 6–10 m, detection angle: 120°, functional mode: on/off: luminaire switches off completely after movement

| Article no. | Colour | Lumin. flux | Colour temp. | Price in € |
|-------------|-------------------|-------------|--------------|------------|
| 65132103 | textured graphite | 700 lm | 3,000 K | 315.50 |



This item is subject to discount group 1.

Product family APORIA

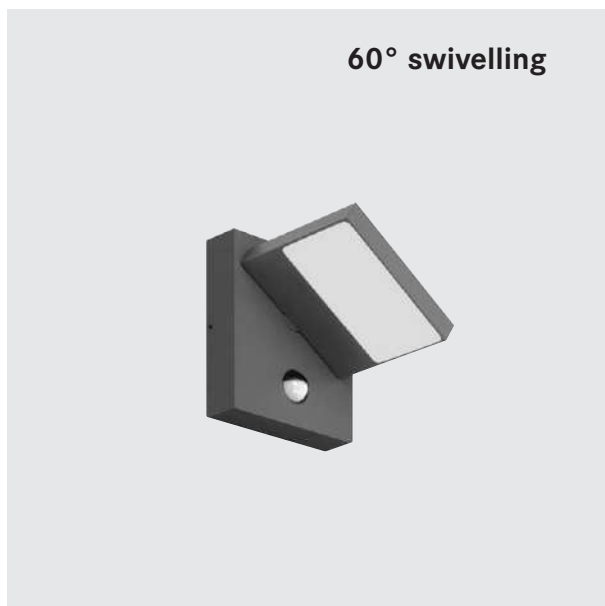

Wall-mounted luminaire

Article no.: 65131103

see page 345

INO and FAGI.

Bollard and wall luminaires for pathway lighting.



Efficient and glare-free.

Motion sensor with a range up to 9 metres.

IP54

IP54 has complete protection against accidental contact, while dust can penetrate in small quantities. In addition, it is protected against water splashing from any direction.

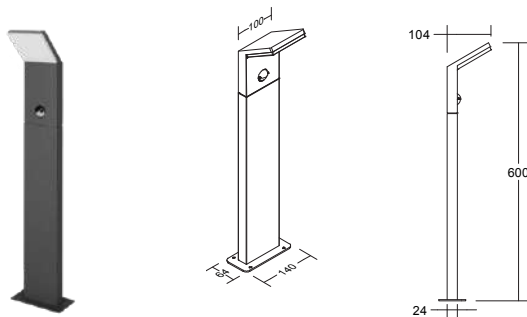

INO LED bollard luminaire, IP54, height 600 mm, switchable

Lamp: LED, colour rendering: CRI > 80, power: 8.5 W, material: aluminium / polycarbonate, includes converter for connection to 230 V mains supply, switchable

Motion sensor and twilight sensor:
Lighting time: adjustable from 5 seconds to 8 minutes, range: max. 9 m, detection angle: 120°, functional mode: on/off: luminaire switches off completely after movement

| Article no. | Colour | Lumin. flux | Colour temp. | Price in € |
|-------------|-------------------|-------------|--------------|------------|
| 65122103 | textured graphite | 680 lm | 3,000 K | 291.00 |

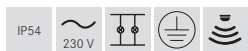

This item is subject to discount group 1.

Product family INO

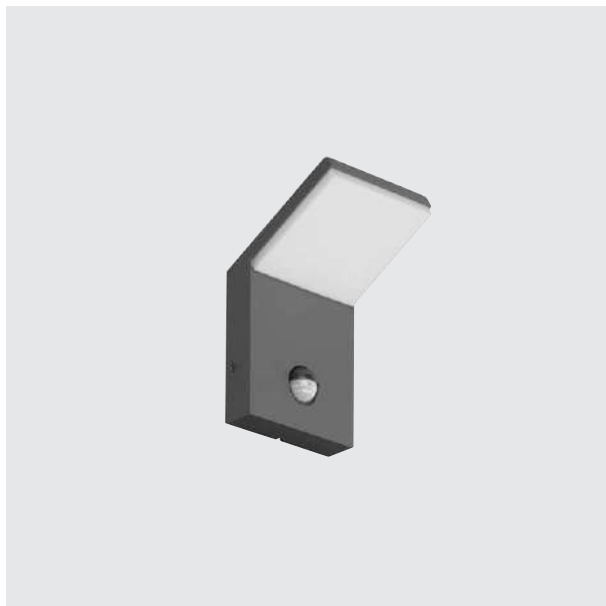

Wall-mounted luminaire

Article no.: 65121103
Article no.: 65123103

see page 347
see page 347

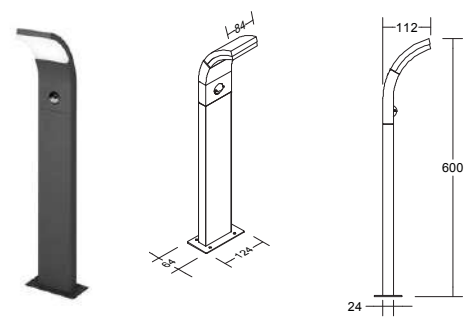

FAGI LED bollard luminaire, IP54, height 600 mm, switchable

Lamp: LED, colour rendering: CRI > 80, power: 6 W, material: aluminium / polycarbonate, includes converter for connection to 230 V mains supply, switchable

Motion sensor and twilight sensor:
Lighting time: adjustable from 5 seconds to 8 minutes, range: max. 9 m, detection angle: 120°, functional mode: on/off: luminaire switches off completely after movement

| Article no. | Colour | Lumin. flux | Colour temp. | Price in € |
|-------------|-------------------|-------------|--------------|------------|
| 65112103 | textured graphite | 480 lm | 3,000 K | 289.10 |

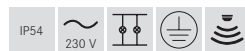

This item is subject to discount group 1.

Product family FAGI



Wall-mounted luminaire

Article no.: 65111103
Article no.: 65113103

see page 346
see page 346

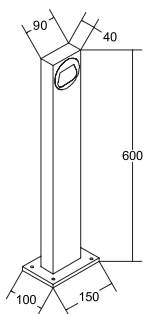

QUADER LED bollard luminaire, IP54, height 600 mm, switchable

Base dimensions: L 100 x W 150 mm

Lamp: LED, colour rendering: CRI > 90, LED power: 9 W, system power: 11 W, base dimensions: L 100 x W 150 mm, material: aluminium / glass, includes converter for 230 V mains supply, switchable and 500 mm connecting cable

| Article no. | Colour | Luminous flux | Colour temp. | Price in € |
|-------------|-------------------|---------------|--------------|------------|
| 60120103 | textured graphite | 730 lm | 3,000 K | 359.90 |



This item is subject to discount group 1.

Product family QUADER



Wall-mounted luminaire, direct

Article no.: 10120103

see page 352

Wall-mounted luminaire, direct/indirect

Article no.: 10121103

see page 352



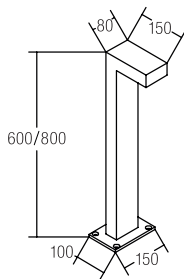

LANTERN LED bollard luminaire, IP65, switchable

Base dimensions: L 100 x W 150 mm

Lamp: LED, colour rendering: CRI > 80, power: 9 W, beam angle: 71°, material: aluminium / glass, includes converter for 230 V mains supply, switchable and 500 mm connecting cable

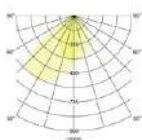

| Article no. | Colour | Lumin. flux | Colour temp. | Height | Price in € |
|-------------|-------------------|-------------|--------------|--------|------------|
| 60006103 | textured graphite | 520 lm | 3,000 K | 600 mm | 249.90 |
| 60036103 | textured graphite | 520 lm | 3,000 K | 800 mm | 389.90 |

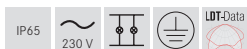

This item is subject to discount group 1.

Product family LANTERN

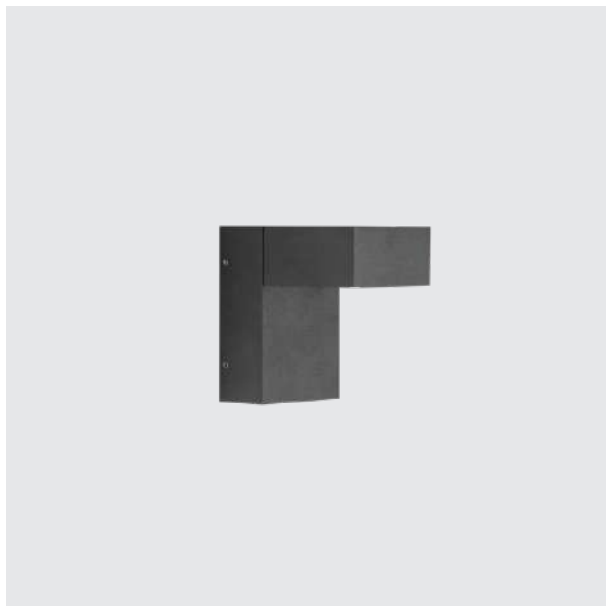

Wall-mounted luminaire

Article no.: 10106103

see page 368

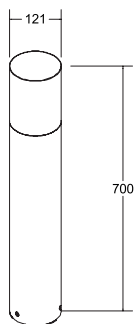

COOQUEE bollard luminaire, IP65, height 700 mm

Lamp: for LED retrofit lamp, lamp holder: E27, power: max. 8 W, material: aluminium / glass, for direct connection to 230 V mains voltage, lamp not included.



| Article no. | Colour | Price in € |
|-------------|----------------|------------|
| 60070180 | textured black | 299.90 |



Accessories: replacement glass 81070000 (with silicone seal)

This item is subject to discount group 1.

Product family COOQUEE



Wall-mounted luminaire

Article no.: 60140180 see page 363

Ceiling-mounted luminaire

Article no.: 60141180 see page 312

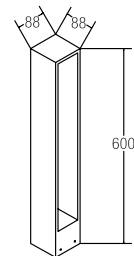

TRIAN LED bollard luminaire, IP54, height 600 mm, switchable

Lamp: LED, colour rendering: CRI > 80, power: 9 W, material: aluminium / glass, includes converter for connection to 230 V mains supply, switchable

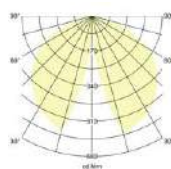

| Article no. | Colour | Lumin. flux | Colour temp. | Price in € |
|-------------|-------------------|-------------|--------------|------------|
| 60007103 | textured graphite | 700 lm | 3,000 K | 329.90 |

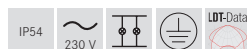

This item is subject to discount group 1.



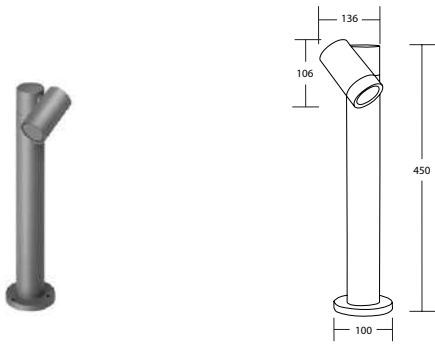

LUZON bollard luminaire, GU10, IP65, height 450 mm

NEW

Lamp: for LED retrofit lamp, lamp holder: GU10, power: 8 W, material: aluminium / glass

| Article no. | Colour | Price in € |
|-------------|-----------------------|------------|
| 65361100 | NEW textured graphite | 119.90 |



These items are subject to discount group 1.

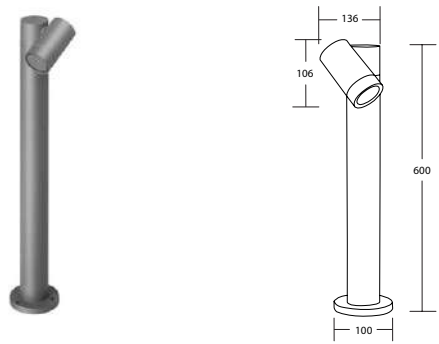

LUZON bollard luminaire, GU10, IP65, height 600 mm

NEW

Lamp: for LED retrofit lamp, lamp holder: GU10, power: 8 W, material: aluminium / glass

| Article no. | Colour | Price in € |
|-------------|-----------------------|------------|
| 65364100 | NEW textured graphite | 129.90 |



These items are subject to discount group 1.

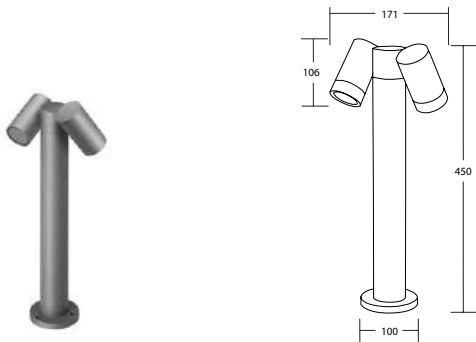

LUZON bollard luminaire, GU10, IP65, height 450 mm

NEW

Lamp: for LED retrofit lamp, lamp holder: GU10, power: 8 W, material: aluminium / glass

| Article no. | Colour | Price in € |
|-------------|-----------------------|------------|
| 65362100 | NEW textured graphite | 139.90 |

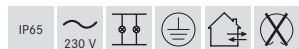

These items are subject to discount group 1.

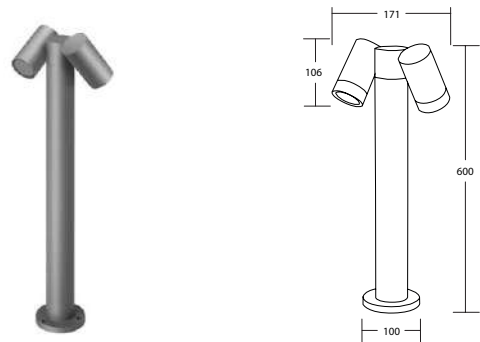

LUZON bollard luminaire, GU10, IP65, height 600 mm

NEW

Lamp: for LED retrofit lamp, lamp holder: GU10, power: 8 W, material: aluminium / glass

| Article no. | Colour | Price in € |
|-------------|-----------------------|------------|
| 65363100 | NEW textured graphite | 149.90 |



These items are subject to discount group 1.

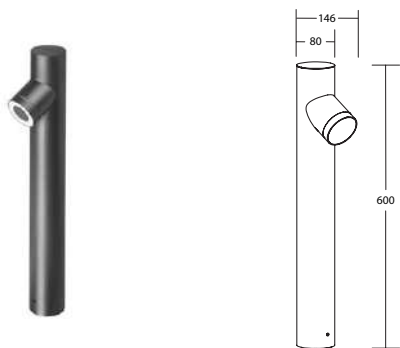

BANKS bollard luminaire, GU 10, IP54, height 600 mm

NEW

Lamp: for LED retrofit lamp, lamp holder: GU10, power: max. 8 W, material: aluminium / glass

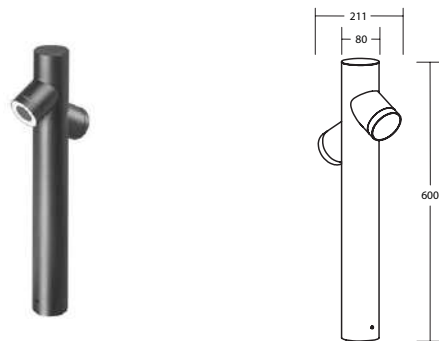

BANKS bollard luminaire, GU 10, IP54, height 600 mm

NEW

Lamp: for LED retrofit lamp, lamp holder: GU10, power: max. 2 x 8 W, material: aluminium / glass

| Article no. | Colour | Price in € |
|-------------|--------------------|------------|
| 65371180 | NEW textured black | 129.90 |



These items are subject to discount group 1.

| Article no. | Colour | Price in € |
|-------------|--------------------|------------|
| 65372180 | NEW textured black | 149.90 |

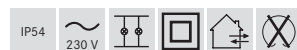

These items are subject to discount group 1.

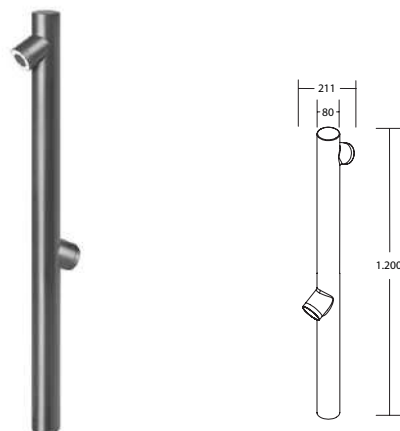

BANKS bollard luminaire, GU 10, IP54, height 1,200 mm

NEW

Lamp: for LED retrofit lamp, lamp holder: GU10, power: max. 2 x 8 W, material: aluminium / glass

| Article no. | Colour | Price in € |
|-------------|--------------------|------------|
| 65373180 | NEW textured black | 179.90 |



These items are subject to discount group 1.

NIOBE.

Aesthetic presence outdoors
for feel-good moments.



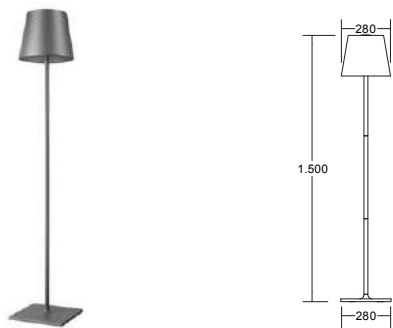

NIOBE free-standing luminaire E27, IP54, height 1,500 mm

Lamp: for LED retrofit lamp, lamp holder: 3 x E27, colour rendering: CRI > 80, power: max. 3 x 15 W, material: aluminium, includes converter for connection to 230 V mains supply, switchable

| Article no. | Colour | Price in € |
|-------------|-------------------|------------|
| 65101103 | textured graphite | 317.10 |

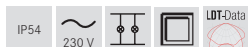

This item is subject to discount group 1.



BIAK free-standing luminaire E27, IP44, height 1,840 mm

NEW

Lamp: for LED retrofit lamp, lamp holder: E27, power: max. 40 W, material: aluminium / plastic, 3,000 mm connecting cable and plug



| Article no. | Colour | Price in € |
|-------------|------------------------------|------------|
| 60121103 | NEW textured graphite | 299.90 |



These items are subject to discount group 1.



BLOKO free-standing luminaire E27, IP54, height 1,500 mm

NEW

Lamp: for LED retrofit lamp, lamp holder: E27, power: max. 40 W, material: aluminium / plastic, 2,000 mm connecting cable and plug

| Article no. | Colour | Price in € |
|-------------|------------------------------|------------|
| 65391100 | NEW textured graphite | 169.90 |

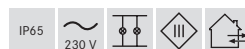

These items are subject to discount group 1.

ALOR.

Light and power source
in one for more
flexibility outdoors.



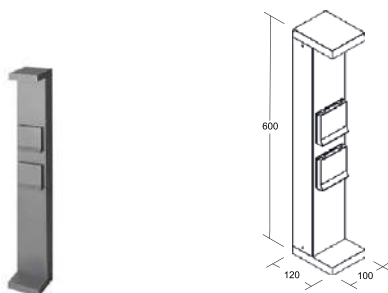

ALOR LED bollard luminaire, IP65, switchable, height 600 mm

NEW

Base dimensions: L 120 x W 100 mm

Lamp: LED, colour rendering: CRI > 80, power: 6 W, material: aluminium / glass, includes converter for connection to 230 V mains supply, switchable and connection box with through-wiring

| Article no. | Colour | Lumin. flux | Colour temp. | Price in € |
|---------------------|-------------------|-------------|-------------------|------------|
| 60046103 NEW | textured graphite | 516 lm | 2,700 K / 3,000 K | 399.90 |



This item is subject to discount group 1.

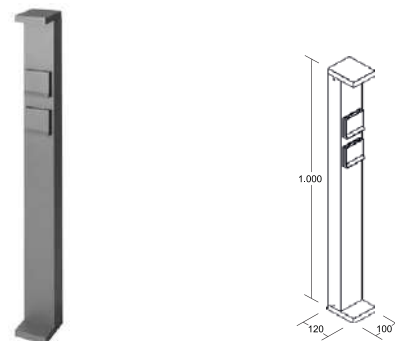

ALOR LED bollard luminaire, IP65, switchable, height 1,000 mm

NEW

Base dimensions: L 120 x W 100 mm

Lamp: LED, colour rendering: CRI > 80, power: 6 W, material: aluminium / glass, includes converter for connection to 230 V mains supply, switchable and connection box with through-wiring

| Article no. | Colour | Lumin. flux | Colour temp. | Price in € |
|---------------------|-------------------|-------------|-------------------|------------|
| 60056103 NEW | textured graphite | 516 lm | 2,700 K / 3,000 K | 449.90 |



This item is subject to discount group 1.

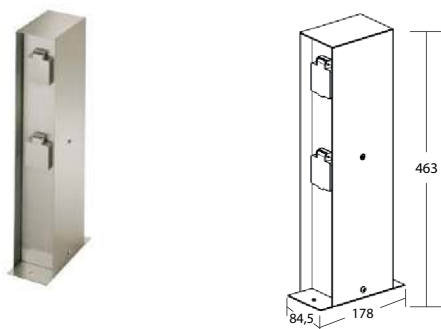

MOROTA POWER energy column, IP44, height 463 mm

NEW

Material: V4A stainless steel, includes converter for connection to 230 V mains voltage, up to a maximum load of 3,680 W

| Article no. | Colour | Price in € |
|---------------------|-----------------|------------|
| 65431220 NEW | stainless steel | 299.90 |



This item is subject to discount group 1.

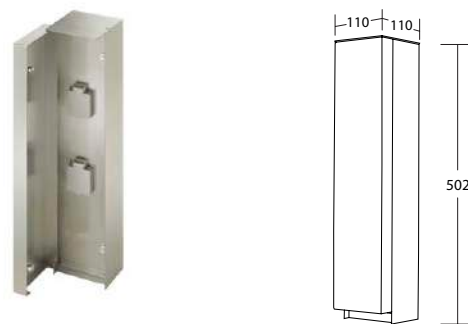

MANSEL POWER energy column, IP44, height 502 mm

NEW

Material: V4A stainless steel, includes converter for connection to 230 V mains voltage, up to a maximum load of 3,680 W

| Article no. | Colour | Price in € |
|---------------------|-----------------|------------|
| 65441220 NEW | stainless steel | 339.90 |



This item is subject to discount group 1.

MATURA.

Light and power for the garden.



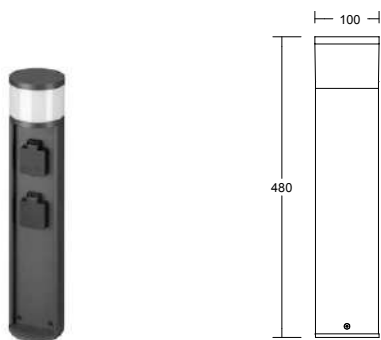

MATURNA LED bollard luminaire / energy column, IP44, height: 480 mm

Lamp: LED, colour rendering: CRI > 80, power: 3 W, material: aluminium / polycarbonate, includes converter for connection to 230 V mains supply, switchable

Total maximum load 3,680 W.



| Article no. | Colour | Lumin. flux | Colour temp. | Price in € |
|-------------|-------------------|-------------|--------------|------------|
| 65201103 | textured graphite | 210 lm | 3,000 K | 219.30 |

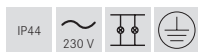

This item is subject to discount group 1.

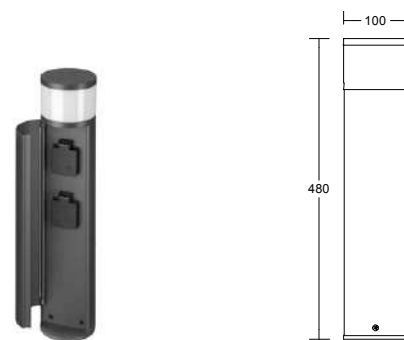

MATURNA LED bollard luminaire / energy column, IP44, height: 480 mm

Lamp: LED, colour rendering: CRI > 80, power: 3 W, material: aluminium / polycarbonate, includes converter for connection to 230 V mains supply, switchable

Total maximum load 3,680 W.



| Article no. | Colour | Lumin. flux | Colour temp. | Price in € |
|-------------|-------------------|-------------|--------------|------------|
| 65202103 | textured graphite | 232 lm | 3,000 K | 235.10 |



This item is subject to discount group 1.

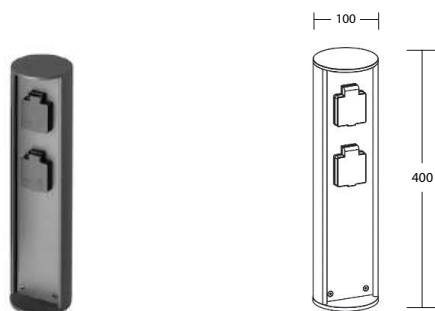

MATURNA POWER energy column, IP44, height 400 mm

NEW

Material: aluminium / plastic, includes converter for connection to 230 V mains voltage, up to a maximum load of 3,680 W

| Article no. | Colour | Price in € |
|-------------|------------------------------|------------|
| 65421100 | NEW textured graphite | 159.90 |



This item is subject to discount group 1.

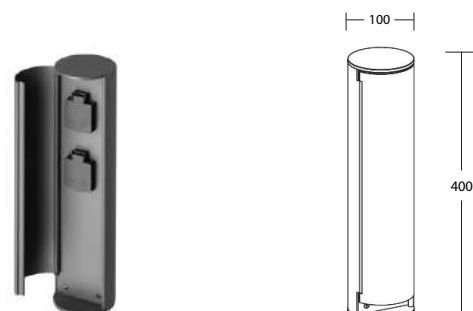

MATURNA POWER energy column, IP44, height 400 mm

NEW

Material: aluminium / plastic, includes converter for connection to 230 V mains voltage, up to a maximum load of 3,680 W

| Article no. | Colour | Price in € |
|-------------|------------------------------|------------|
| 65422100 | NEW textured graphite | 179.90 |



This item is subject to discount group 1.

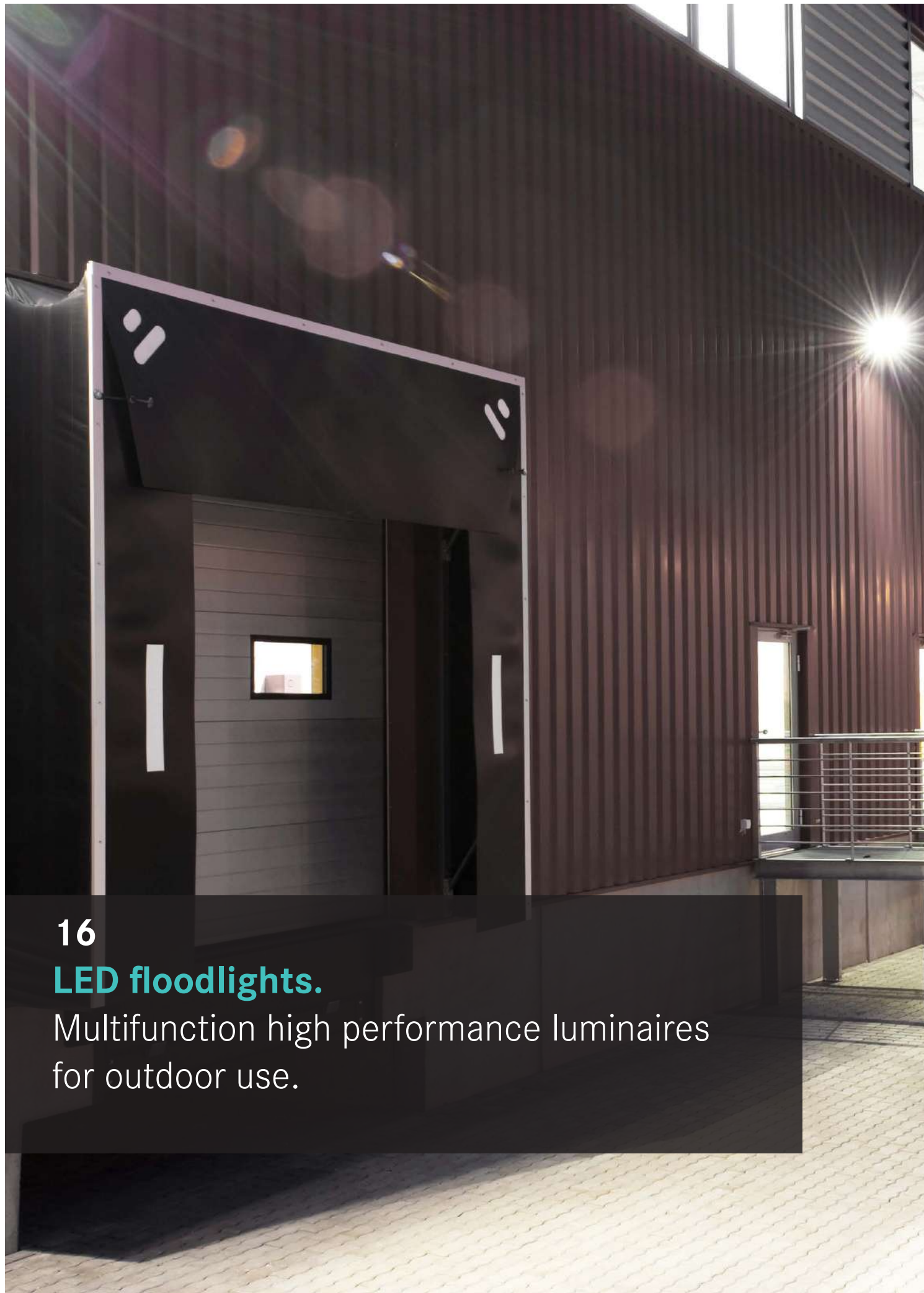

16

LED floodlights.

Multifunction high performance luminaires for outdoor use.



MATRIX LED floodlight.

Flexible exterior applications.

Now in
2 new
sizes.

More than 140 lm/W.



Product advantages:

- 5-year Brumberg guarantee
(Registration on the Brumberg website in the Services section).
- More than 140 lm/W.
- Dust-tight and waterproof with IP66.
- Internal cooling pins for optimum heat dissipation and long product life.
- Extremely temperature-resistant between -25 °C and +50 °C.
- Wall and mast mounting possible (using accessories).
- Powerful with 20 W, 50 W, 100 W, 225 W or 275 W.
- Corrosion-resistant housing made of die-cast aluminium with a pressure compensation valve built into the housing.

IP66 IK08

IP66 is the highest protection class against foreign objects combined with protection against powerful jets of water.

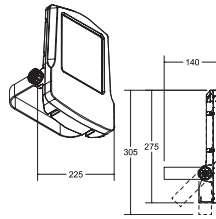

Micro
Art. no. 60801... / 60802...

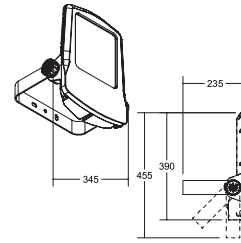

Mini
Art. no. 60803... / 60804...

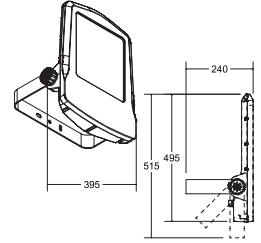

Midi
Art. no. 60805... / 60806...

MATRIX LED floodlight, IP66, switchable

NEW

Lamp: LED, colour rendering: CRI > 80, beam angle: 100°, material: aluminium / glass, includes converter for connection to 230 V mains supply, switchable, cable length: 800 mm, including cable connector and with a pressure compensation valve built into the top of the housing.

Service life:

L80/B10, 50,000 hrs. (ta: +25 °C)

Symmetrical light distribution

| Article no. | Colour | Lumin. flux | Power | Colour temp. | System efficiency | Weight | Price in € |
|-------------|-------------------|-------------|-------|--------------|-------------------|---------|------------|
| 60801643 | matt titanium | 2,810 lm | 20 W | 3,000 K | 140 lm/W | 2.6 kg | 329.90 |
| 60801644 | matt titanium | 2,890 lm | 20 W | 4,000 K | 144 lm/W | 2.6 kg | 329.90 |
| 60803643 | matt titanium | 7,020 lm | 50 W | 3,000 K | 140 lm/W | 7.0 kg | 549.90 |
| 60803644 | matt titanium | 7,240 lm | 50 W | 4,000 K | 145 lm/W | 7.0 kg | 549.90 |
| 60805643 | matt titanium | 14,050 lm | 100 W | 3,000 K | 140 lm/W | 9.1 kg | 692.90 |
| 60805644 | matt titanium | 14,480 lm | 100 W | 4,000 K | 145 lm/W | 9.1 kg | 692.90 |
| 60807643 | NEW matt titanium | 28,900 lm | 225 W | 3,000 K | 128 lm/W | 19.0 kg | 1,399.90 |
| 60807644 | NEW matt titanium | 30,900 lm | 225 W | 4,000 K | 137 lm/W | 19.0 kg | 1,399.90 |
| 60809643 | NEW matt titanium | 34,100 lm | 275 W | 3,000 K | 124 lm/W | 19.0 kg | 1,449.90 |
| 60809644 | NEW matt titanium | 36,500 lm | 275 W | 4,000 K | 137 lm/W | 19.0 kg | 1,449.90 |

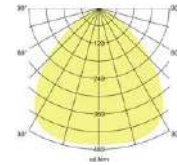

Asymmetrical light distribution

| Article no. | Colour | Lumin. flux | Power | Colour temp. | System efficiency | Weight | Price in € |
|-------------|-------------------|-------------|-------|--------------|-------------------|---------|------------|
| 60802643 | matt titanium | 2,500 lm | 20 W | 3,000 K | 125 lm/W | 2.6 kg | 329.90 |
| 60802644 | matt titanium | 2,710 lm | 20 W | 4,000 K | 136 lm/W | 2.6 kg | 329.90 |
| 60804643 | matt titanium | 8,036 lm | 50 W | 3,000 K | 160 lm/W | 7.0 kg | 549.90 |
| 60804644 | matt titanium | 8,466 lm | 50 W | 4,000 K | 169 lm/W | 7.0 kg | 549.90 |
| 60806643 | matt titanium | 13,380 lm | 100 W | 3,000 K | 133 lm/W | 9.1 kg | 692.90 |
| 60806644 | matt titanium | 14,100 lm | 100 W | 4,000 K | 141 lm/W | 9.1 kg | 692.90 |
| 60808643 | NEW matt titanium | 29,300 lm | 225 W | 3,000 K | 130 lm/W | 19.0 kg | 1,399.90 |
| 60808644 | NEW matt titanium | 30,300 lm | 225 W | 4,000 K | 135 lm/W | 19.0 kg | 1,399.90 |
| 60810643 | NEW matt titanium | 34,600 lm | 275 W | 3,000 K | 126 lm/W | 19.0 kg | 1,449.90 |
| 60810644 | NEW matt titanium | 37,000 lm | 275 W | 4,000 K | 135 lm/W | 19.0 kg | 1,449.90 |

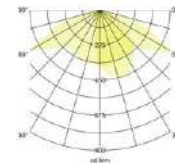

Beam angle: 30 x 110°

These items are subject to discount group 2.

Accessories for MATRIX LED floodlight

| Article no. | Description | Price in € |
|-------------|--|------------|
| 81100640 | Extension adapter for 20 W LED floodlights (Micro) | 120.90 |
| 81101640 | Extension adapter for 50 W LED floodlights (Mini) | 120.90 |
| 81102640 | Extension adapter for 100 W LED floodlights (Midi) | 120.90 |
| 81120640 | NEW Mast bracket for 20 W LED floodlights (Micro) | 36.90 |
| 81121640 | NEW Mast bracket for 50 W LED floodlights (Mini) | 36.90 |
| 81122640 | NEW Mast bracket for 100 W LED floodlights (Midi) | 36.90 |

These items are subject to discount group 2.



NEO.

Efficient, functional and reliable.

High-quality, efficient and durable LED technology.



IP65
IK08

IP65 has complete protection against accidental contact. Dust cannot penetrate and it is protected against jets of water in any direction.

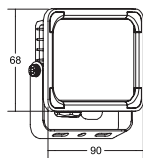

60811...

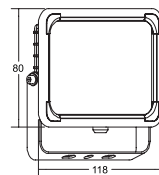

60812...

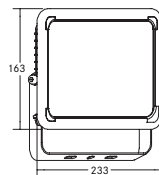

60813...



NEO LED floodlight, IP65, switchable

Lamp: LED, colour rendering: CRI > 80, glare rating: UGR < 25, beam angle: 120°, material: aluminium / glass, includes converter for 230 V mains supply and 1,000 mm connecting cable

Service life:

L80/B10, 50,000 hrs. (ta: +25 °C)

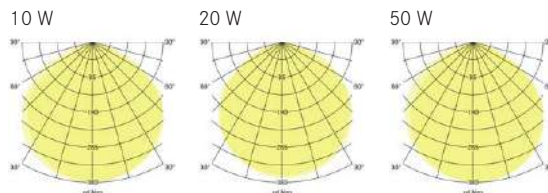

| Article no. | Colour | Power | Lumin. flux | Colour temp. | Price in € |
|-------------|----------------|-------|-------------|--------------|------------|
| 60811183 | textured black | 10 W | 1,120 lm | 3,000 K | 24.90 |
| 60811184 | textured black | 10 W | 1,220 lm | 4,000 K | 24.90 |
| 60812183 | textured black | 20 W | 2,380 lm | 3,000 K | 34.90 |
| 60812184 | textured black | 20 W | 2,400 lm | 4,000 K | 34.90 |
| 60813183 | textured black | 50 W | 5,450 lm | 3,000 K | 79.90 |
| 60813184 | textured black | 50 W | 6,100 lm | 4,000 K | 79.90 |

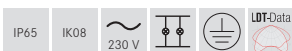

These items are subject to discount group 2.

University of Music, Stuttgart.

From conventional
to highly efficient lighting technology.

Right from the beginning, it was important for this particular project that the visual appearance and architecture of the entire music academy was not altered for the more efficient lighting, so that the charm of the building could be preserved.

To achieve this, around 200 luminaires with conventional halogen technology were replaced by highly efficient LED luminaires in the large 500-seat concert hall at the University of Music Stuttgart. Due to the specially designed luminaires, the existing ceiling cut-outs remained in use. The rear walls have been illuminated with new RGBW downlights to create a colourful accent. The lighting of the stage and the main room was realised with LED downlights in 3,000 K, and the chamber music hall and orchestra rehearsal room were also converted to LED and RGBW.



We have managed to achieve energy savings of a remarkable 80 % by replacing the 150 - 200 W lamps by efficient LEDs with just 38 W.

Rudolf Raber, Head of the Joint Technical Service of the University of Music and the Haus der Geschichte (House of History)

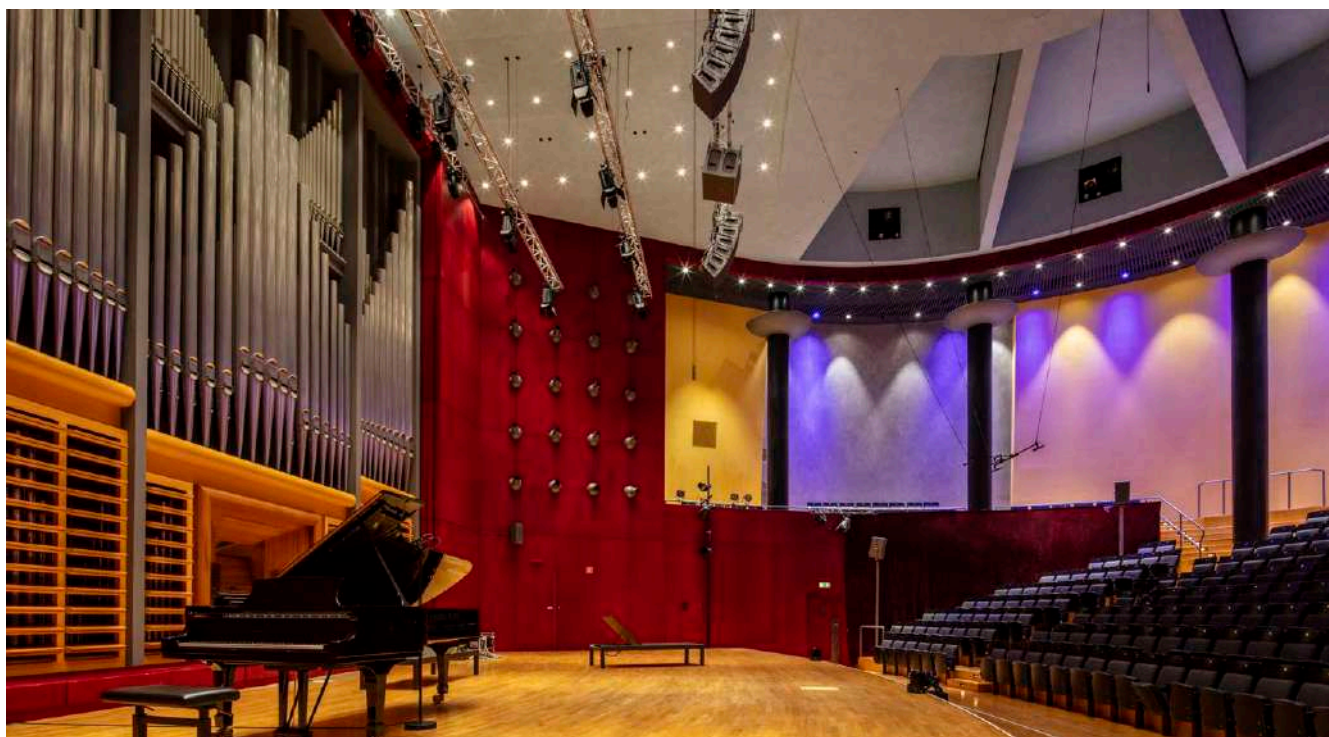



House of History and University of Music Stuttgart.

Luminaires revitalised.

At the House of History Baden-Württemberg in Stuttgart, we have equipped existing luminaires and theatre spotlights with the latest SMD LED chip technology to revitalise them. The conversion of the old luminaires to LED lighting took a total of four years. The Brumberg project team also designed new lighting solutions with QualityFlex and vitaLED, which bring the impressive history and numerous facets of Baden-Württemberg to life in the House of History. The entire complex is a listed building, built in 1994 and 2002.

We see the ban on fluorescent lamps as a step forward and a great opportunity for our future. The focus should not just be on replacing them with energy-efficient LED luminaires - revitalisation can be an even more comprehensive solution. When revitalising luminaires, we retain the luminaire housings and luminaire design of the existing luminaires, gut them and install highly efficient LED technology. In this way, the overall impression of the building is not disturbed, the building architecture is preserved and intact materials can remain in use. This way, resources are saved through energy-efficient lamps, and also by retaining the existing housings instead of replacing them completely.



Andreas Roder Dipl.-Ing. Head of Product / Technology / CTO



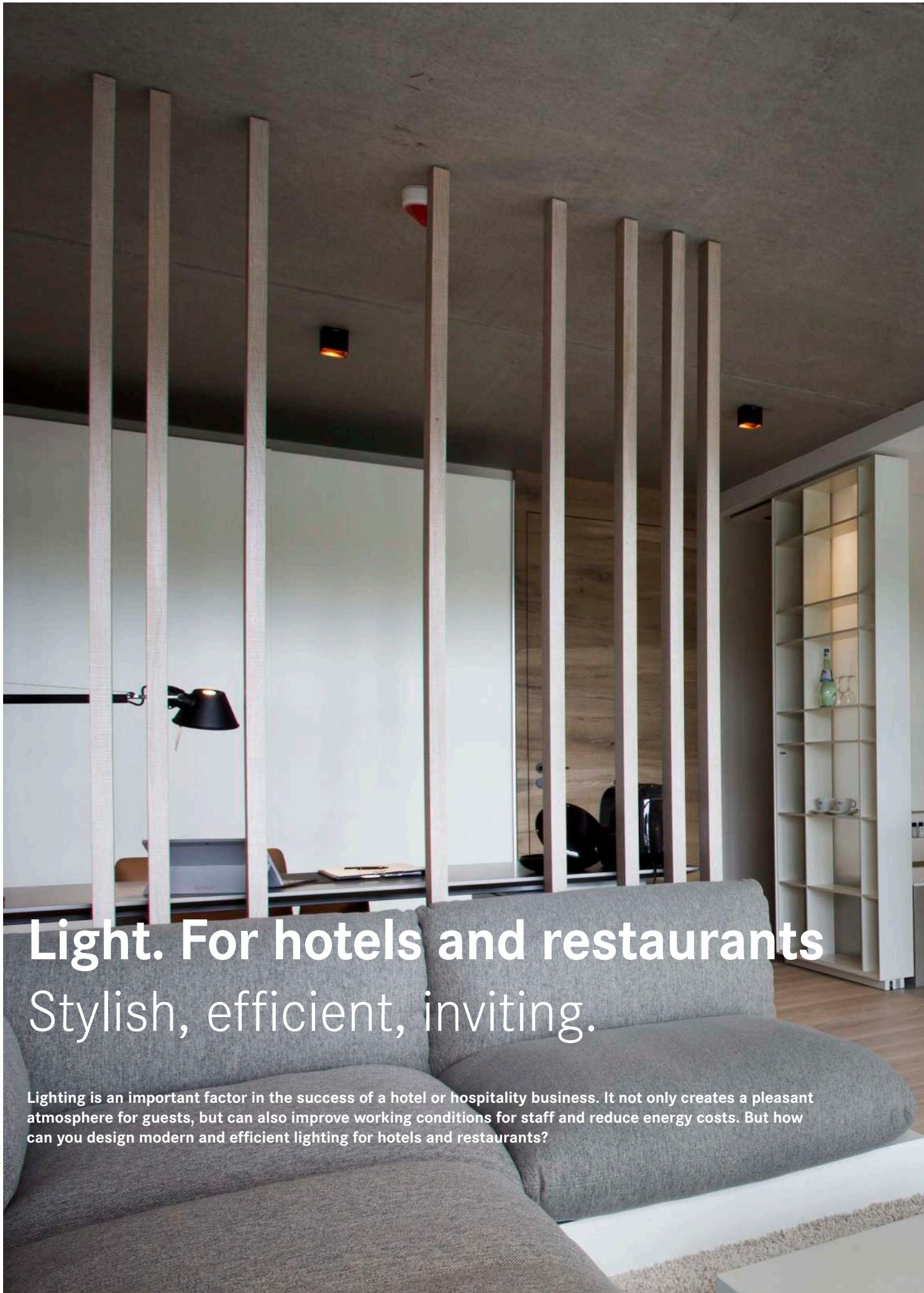

Light. For hotels and restaurants

Stylish, efficient, inviting.

Lighting is an important factor in the success of a hotel or hospitality business. It not only creates a pleasant atmosphere for guests, but can also improve working conditions for staff and reduce energy costs. But how can you design modern and efficient lighting for hotels and restaurants?



Modern lighting is distinguished by high quality, flexibility and individuality. It can be customised to suit the different demands and functions of the rooms, from the lobby through the guest rooms to the restaurant or bar. The use of different light sources and colours will create the desired mood and emphasise the architecture and interior. Efficient lighting takes advantage of the latest technologies to reduce energy consumption and maintenance costs. Above all, this includes LED luminaires, with their long service life, high luminous efficacy and low heat generation. They can also be easily dimmed and controlled to achieve the optimum brightness and colour temperature for every situation.

There are several aspects to consider when realising modern and efficient lighting for hotels and restaurants. First, you should conduct thorough lighting planning that takes the needs and wishes of guests and staff into account. You should also comply with the legal regulations and standards that are relevant for safety and fire protection.

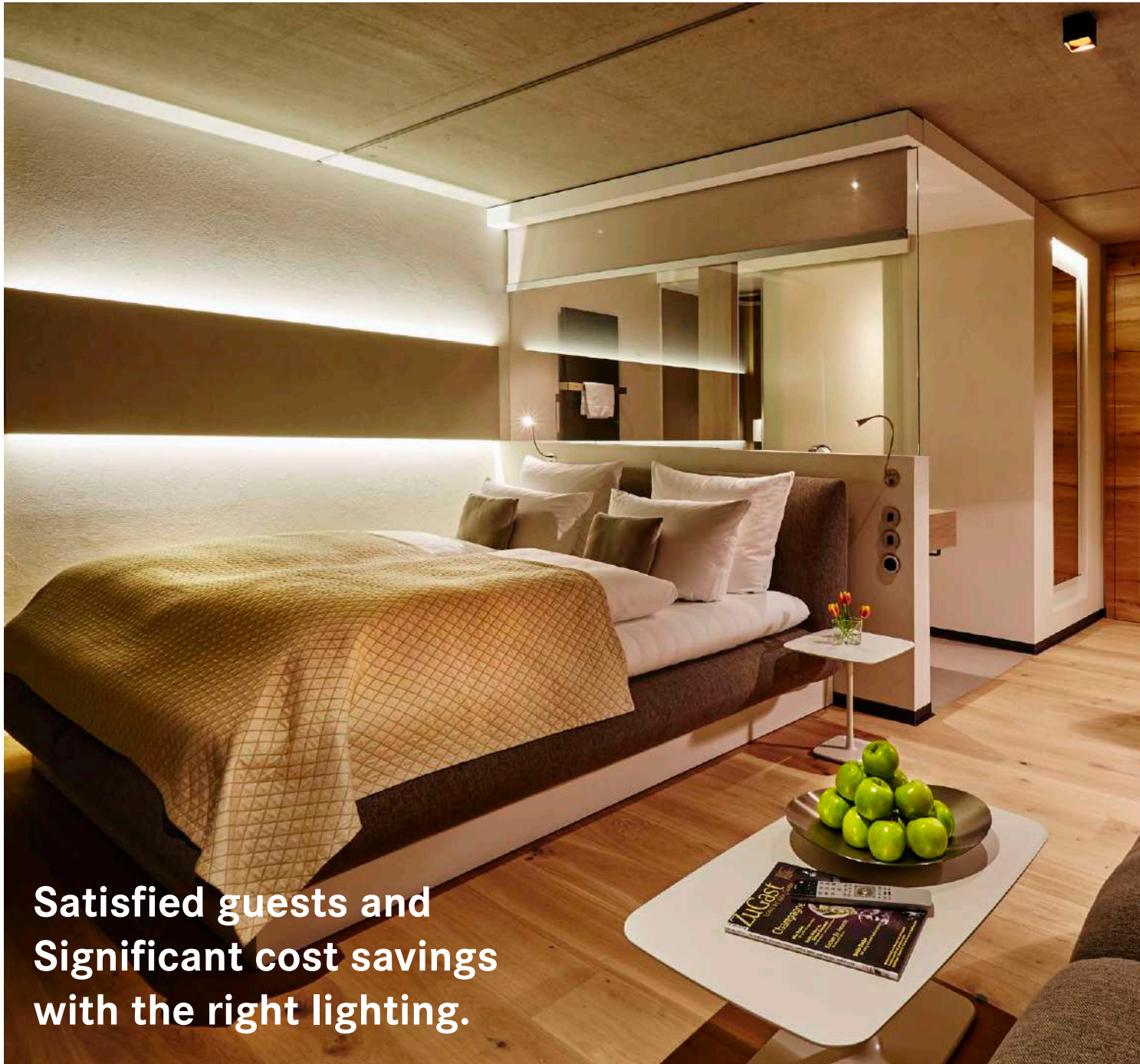

**Satisfied guests and
Significant cost savings
with the right lighting.**

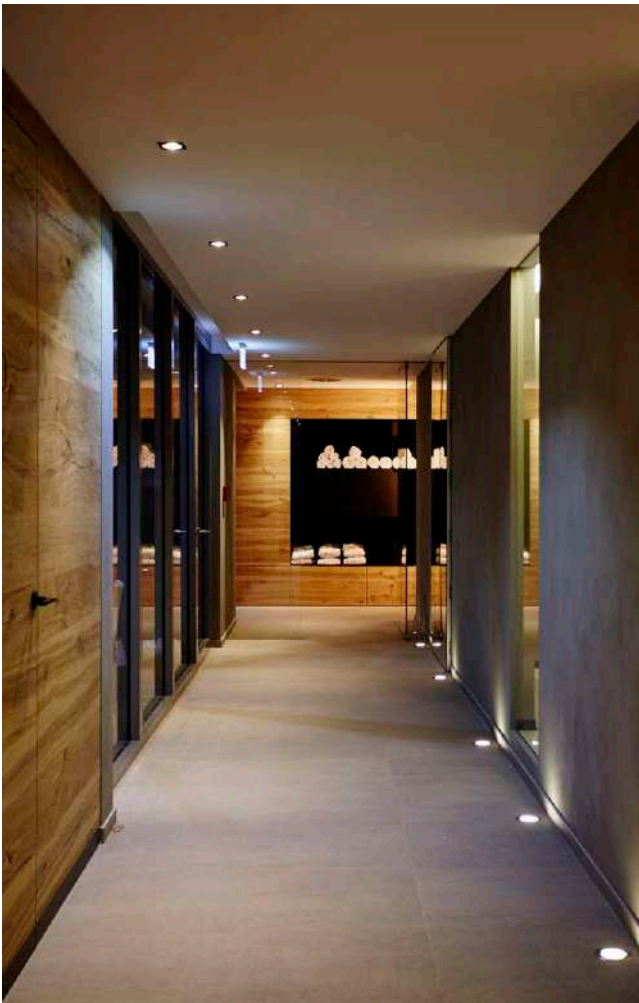
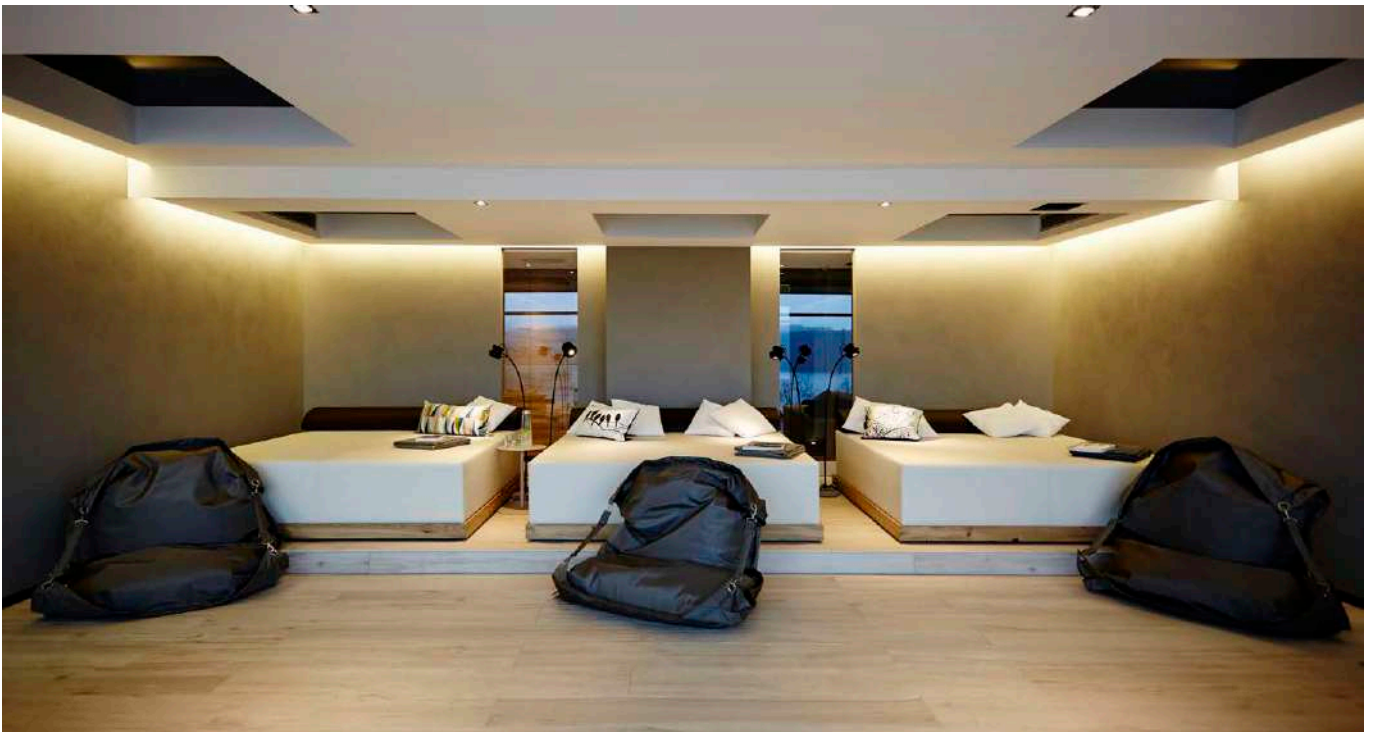

Conventional office areas.

- Individual offices
- Group and open-plan offices
- Meeting rooms

New Work.

- Open spaces
- Coworking spaces
- Communication and inspiration zones

Secondary areas.

- Entrance and reception
- Exhibition areas
- Corridors and stairwells

Modern and efficient lighting for hotels and restaurants is therefore a worthwhile investment that can increase both guest satisfaction and the profitability of the business. Good lighting design and professional implementation can create an illumination that is versatile, unique and inviting.

Eiswiese bathing paradise, Göttingen

A BRIEF HOLIDAY FOR THE SENSES.

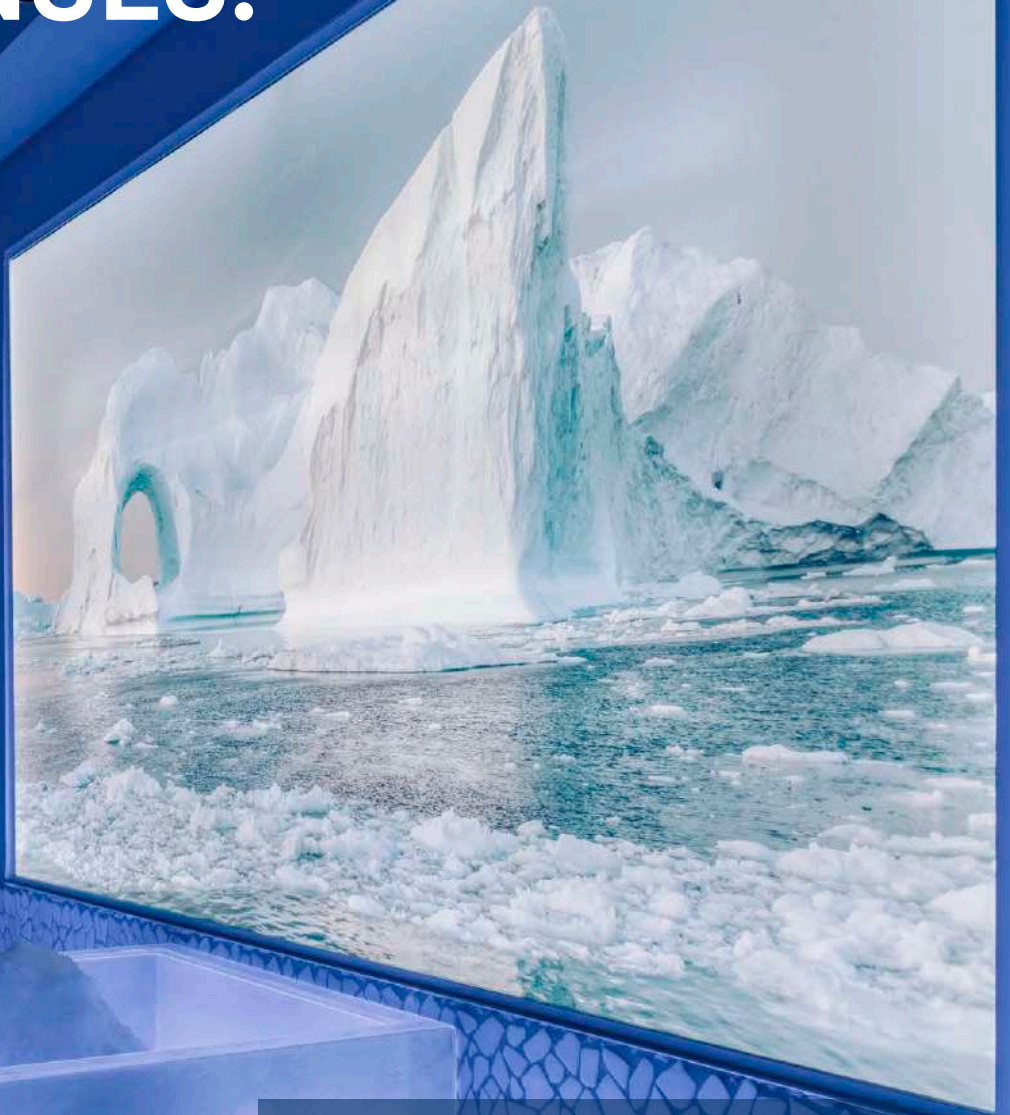

Profile

Project: Eiswiese bathing paradise, Göttingen

Building owner: Göttinger Sport und Freizeit GmbH & Co. KG

Products: vitaLED, umbrella lights, bollard lights and much more

Scope: consultancy, planning

Photographer: Boris Golz

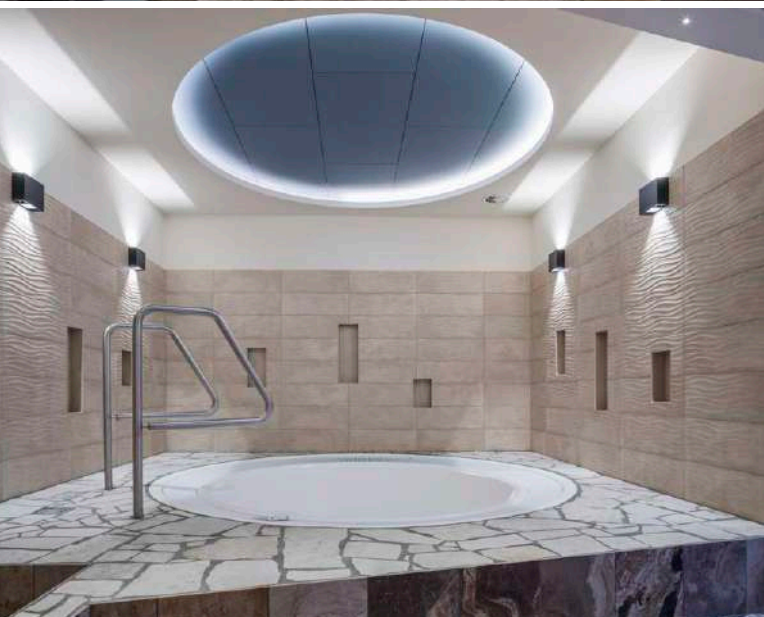
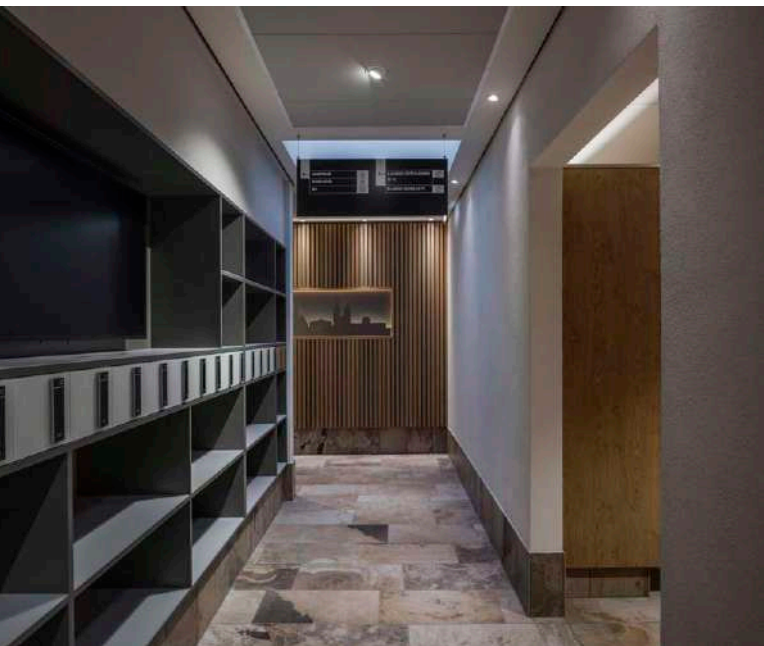

Light. Knowledge.

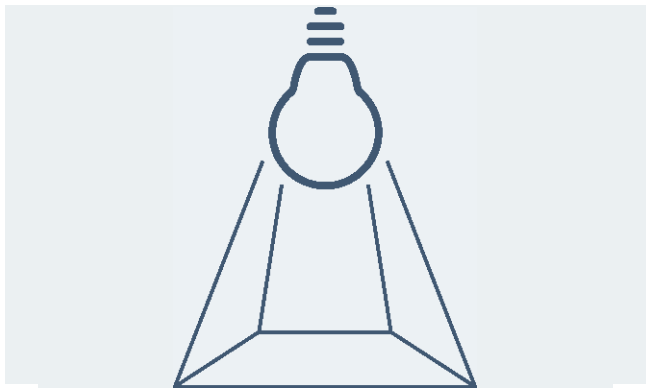

Lux.

Illuminance is measured in lux. The term is derived from the Latin word for "light". The unit of measurement is defined as the photometric illumination produced by a luminous flux of 1 lumen when evenly distributed over an area of 1 square metre.



Lumen.

The luminous flux is measured in lumens (lm). It describes the power emitted by a light source in all directions in the visible range. In the era of efficient LEDs, the lumen rating is gradually replacing the wattage as a measure of brightness.



Kelvin.

The Kelvin unit indicates the colour temperature of a lamp. Common lamps have colour temperatures ranging from below 3,300 Kelvin (warm white), 3,300 to 5,300 Kelvin (neutral white) to over 5,300 Kelvin (daylight white). A luminaire with a low Kelvin number therefore emits warm white light. The higher the Kelvin value, the cooler the lighting temperature.



2700 K CRI 100



2700 K CRI 90



2700 K CRI 80



2700 K CRI 70

CRI.

Colour rendering describes how natural an object looks when illuminated by an artificial light source. The colour rendering index: Colour Rendering Index, abbreviated to CRI. The closer the value is to 100, the more it corresponds to the colour rendering of sunlight. A light source whose light contains all spectral colours makes the colours of the illuminated objects look natural - the colour rendering is optimal. ■

LIGHT. FOR PEOPLE.

The biological and psychological effects of light have now been proven by numerous studies. Natural light and artificial lighting affect our well-being and have an impact on the body. Anyone who places people in the focus of lighting design will ensure biologically and psychologically effective lighting with a supportive effect at any time of day or night. We have summarised the most important aspects of Human Centric Lighting for you.

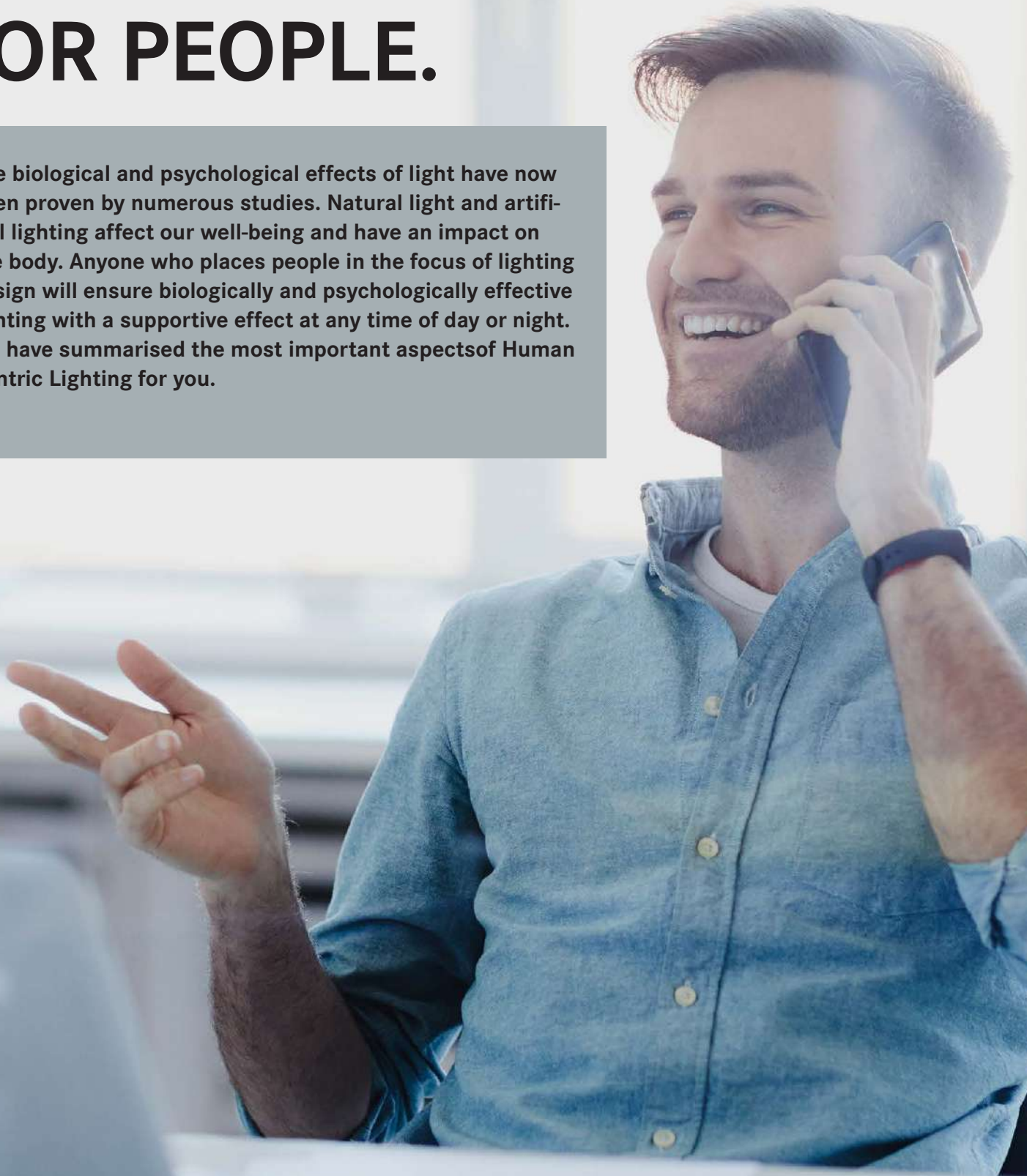

HUMAN CENTRIC LIGHTING.

The term "Human Centric Lighting" is now used to describe lighting applications that focus specifically on people and their well-being. In recent years, awareness of the influence of lighting on people's health and well-being has increasingly developed in the light of far-reaching new findings from intensive research activities. Today, these findings are leading us to redefine good lighting. Alongside creating good visual conditions and the spatial light distribution, it is also important to consider the spectral composition during the course of the day when planning and realising many applications.

Light influences the biorhythm.

In the past 100 years or so, humans have created a global 24-hour society - contrary to the natural day-night cycle - in which

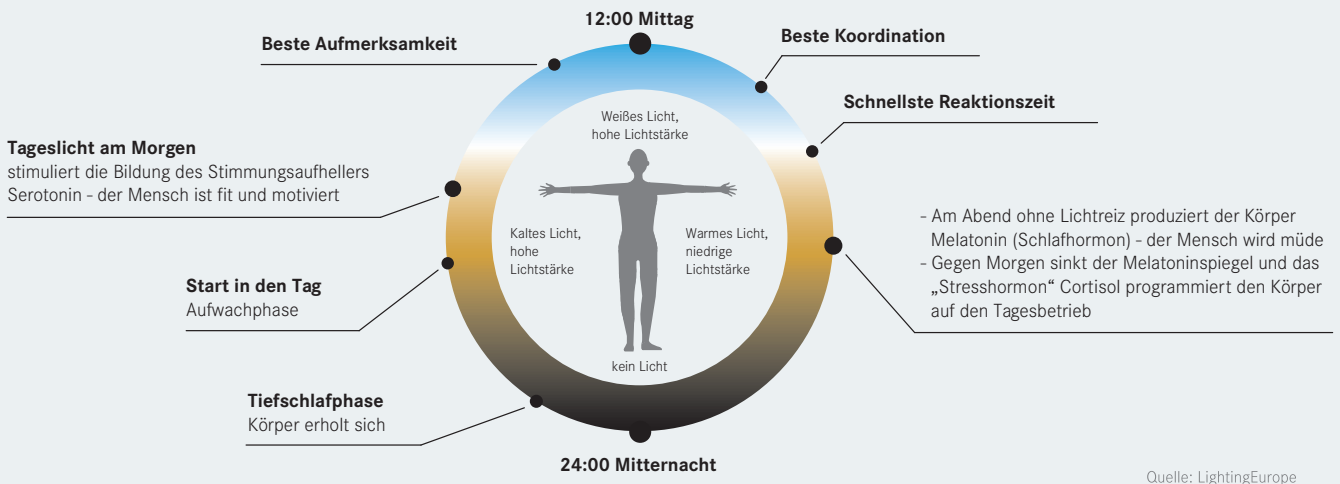

they are seemingly independent of the circadian rhythm according to the motto "light turns night into day". Artificial light should, for reasons of health and well-being, be orientated on natural light and specifically integrated into the course of the day. The key aspect here is the biological effect of light on our internal clock. Yet we should not neglect the emotional, psychological effect of lighting either.

An additional photoreceptor in the eye was discovered in 2000, which plays an important role in this biological, non-visual light effect. This photosensitive ganglion cell, which is not involved in the actual visual process, reacts particularly to light wavelengths in the short-wave, "blue" range of the spectrum of approx. 480 nm. Ever since its discovery, science and industry have been working on understanding its non-visual effect on people and thereby generating a level of knowledge that is also gradually reflecting in the application of light. In particular, the discovery of the protein melanopsin, which as a photopigment makes the newly discovered ganglion cells sensitive to light, coined the term "melanopic efficiency" of light.

Light as a mood booster.

One thing is certain: the composition and intensity of the spectrum emitted by different light sources have different effects on people. The right lighting can increase well-being and positively influence the mood. Light can also support activation or relaxation.

So Human Centric Lighting is distinct from purely technical lighting wherever light is intended to have a psychological, physiological or psychobiological effect on people.

Light. Knowledge.

TREAT WINTER DEPRESSION.

Biologically effective light is also used to treat various vegetative disorders. Light therapy has already proven its worth in the treatment of seasonal affective disorder (SAD), which occurs during the darker months of the year. Initial investigations show: this method can also be used to treat other forms of depression and additional conditions.

People need light.

A lack of light is a real problem, especially in the cold season. Around 5 to 20 per cent of the total population develop down-right deficiency symptoms if there is a lack of sufficient natural light. This can cause seasonal affective disorder (SAD), which then needs to be treated. The main difference between SAD and other forms of depression is that the symptoms subside as the days get longer in spring, but reappear in autumn.

Seasonal Affective Disorder (SAD).

Unlike other depressive patients, those affected do not suffer from insomnia. On the contrary: you go to bed earlier than in summer and still have difficulty getting up. Scientists believe that SAD is caused by a malfunction of the light receptors on the retina on the one hand and an insufficiently pronounced sleep-wake rhythm on the other. It is likely that SAD patients adapt less well to the shorter winter days. A deficiency in the absolute amount of light is also being discussed. This is backed up by the fact that in cold Alaska around one in three adults is affected by SAD, compared to only one in 25 in sunny Florida.

Therapy devices with daylight spectrum.

If you don't get enough daylight, light therapy devices are a real alternative. According to current medical knowledge, light therapy works exclusively via the eye. If daylight strikes the retina, the pituitary gland in the diencephalon produces hormones and messenger substances such as serotonin. This neurotransmitter brightens the mood, increases well-being and motivates. Light therapy devices reproduce the intensity and colour temperature of daylight so that the body can release more serotonin. The result: people are awake during the day and sleep better at night. To achieve this effect, conventional lighting at the workplace is generally not sufficient. ■

RECOGNISE THE SURROUNDINGS CLEARLY.

You know the drill: if the brightness is constantly changing, the eyes become irritated and tired more quickly. This is because they need to compensate constantly for differences in contrast. Too small differences in luminance also cause fatigue, as they quickly make a room appear monotonous. We have summarised the most important facts about brightness distribution for you.

Harmonious brightness distribution.

If you want to achieve a balanced distribution of brightness, you should ensure that the luminance of objects stands out clearly from their surroundings. In road traffic, this is clearly regulated by EN 13201 for roads. This standard requires uniform illumination of the carriageway and is intended to avoid dark zones. Similarly, significant differences in room brightness should be avoided so that, for instance, hazards can be quickly recognised in workplace lighting. The European standard EN 12464-1 therefore also recommends a balanced distribution of luminance levels for indoor workplaces. They make a significant contribution to visual performance and visual comfort.

Balanced luminances.

The luminance levels of all surfaces must be considered to achieve a harmonious brightness distribution. They are determined by the reflectance of the surfaces and the illuminance on the surfaces. Recommended reflectance values are in accordance with EN 12464-1: ceiling: 0.7 to 0.9, walls: 0.5 to 0.8, floor: 0.2 to 0.4. Also, the luminance ratio between the work area and the immediate surroundings should not exceed approximately 3:1. The luminance ratio between the work area and distant surfaces should be a maximum of 10:1. ■

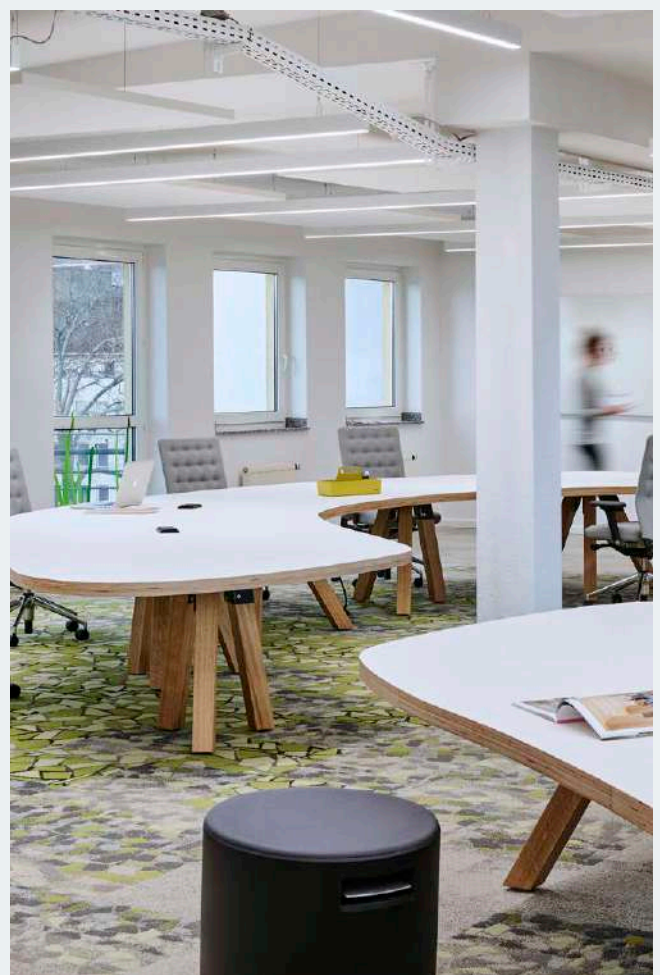

| Article no. | Page | Price in € | Discount group | Product group | Article no. | Page | Price in € | Discount group | Product group | Article no. | Page | Price in € | Discount group | Product group |
|-------------|------|------------|----------------|---------------|-------------|------|------------|----------------|---------------|-------------|------|------------|----------------|---------------|
| 00006302 | 158 | 25.90 € | 1 | 688 | 10106103 | 368 | 227.80 € | 1 | 693 | 12036854TW | 163 | 152.20 € | 1 | 679 |
| 00006307 | 158 | 24.80 € | 1 | 688 | 10114173 | 183 | 222.90 € | 1 | 679 | 12122173 | 183 | 154.90 € | 1 | 679 |
| 00006308 | 158 | 24.80 € | 1 | 688 | 10114183 | 183 | 222.90 € | 1 | 679 | 12122183 | 183 | 154.90 € | 1 | 679 |
| 00006317 | 158 | 24.80 € | 1 | 688 | 10115173 | 183 | 259.90 € | 1 | 679 | 12123173 | 183 | 188.90 € | 1 | 679 |
| 00006325 | 158 | 24.80 € | 1 | 688 | 10115183 | 183 | 259.90 € | 1 | 679 | 12123183 | 183 | 188.90 € | 1 | 679 |
| 00006363 | 158 | 30.80 € | 1 | 688 | 10120103 | 352 | 159.90 € | 1 | 693 | 12165023 | 169 | 61.00 € | 1 | 679 |
| 00006364 | 158 | 30.80 € | 1 | 688 | 10121103 | 352 | 249.90 € | 1 | 693 | 12165073 | 169 | 61.00 € | 1 | 679 |
| 00006378 | 158 | 30.80 € | 1 | 688 | 10130183 | 327 | 129.90 € | 1 | 679 | 12165083 | 169 | 61.00 € | 1 | 679 |
| 00006502 | 160 | 28.60 € | 1 | 688 | 10131183 | 327 | 159.90 € | 1 | 679 | 12165153 | 169 | 61.00 € | 1 | 679 |
| 00006507 | 160 | 27.00 € | 1 | 688 | 10136173 | 325 | 169.90 € | 1 | 693 | 12205073 | 175 | 56.10 € | 1 | 679 |
| 00006508 | 160 | 27.00 € | 1 | 688 | 10136183 | 325 | 169.90 € | 1 | 693 | 12206073 | 175 | 78.00 € | 1 | 679 |
| 00006517 | 160 | 27.00 € | 1 | 688 | 10137173 | 325 | 189.90 € | 1 | 693 | 12207073 | 175 | 116.50 € | 1 | 679 |
| 00006525 | 160 | 27.00 € | 1 | 688 | 10137183 | 325 | 189.90 € | 1 | 693 | 12208073 | 178 | 189.90 € | 2 | 2638 |
| 00006563 | 160 | 33.00 € | 1 | 688 | 10170183 | 366 | 109.90 € | 1 | 679 | 12208083 | 178 | 189.90 € | 2 | 2638 |
| 00006564 | 160 | 33.00 € | 1 | 688 | 10171183 | 366 | 114.90 € | 1 | 679 | 12209073 | 178 | 259.90 € | 2 | 2638 |
| 00006578 | 160 | 33.00 € | 1 | 688 | 10221103 | 337 | 139.90 € | 1 | 693 | 12209083 | 178 | 259.90 € | 2 | 2638 |
| 00118022 | 300 | 98.90 € | 1 | 688 | 10222103 | 337 | 139.90 € | 1 | 693 | 12214073 | 178 | 299.90 € | 2 | 2638 |
| 00118122 | 301 | 104.40 € | 1 | 688 | 10223103 | 337 | 139.90 € | 1 | 693 | 12214083 | 178 | 299.90 € | 2 | 2638 |
| 00310500 | 391 | 109.90 € | 1 | 693 | 10224103 | 337 | 139.90 € | 1 | 693 | 12259073 | 179 | 299.90 € | 2 | 2638 |
| 00317700 | 366 | 319.90 € | 1 | 693 | 12002034 | 166 | 45.00 € | 1 | 700 | 12259083 | 179 | 299.90 € | 2 | 2638 |
| 00532700 | 147 | 2.70 € | 1 | 675 | 12003034 | 166 | 47.50 € | 1 | 700 | 12260073 | 179 | 339.90 € | 2 | 2638 |
| 00532700 | 149 | 2.70 € | 1 | 675 | 12035173DW | 163 | 152.20 € | 1 | 679 | 12260083 | 179 | 339.90 € | 2 | 2638 |
| 00532900 | 13 | 12.00 € | 2 | 2941 | 12035174TW | 163 | 152.20 € | 1 | 679 | 12356173 | 173 | 42.40 € | 1 | 679 |
| 10013103 | 355 | 349.90 € | 1 | 693 | 12035183DW | 163 | 152.20 € | 1 | 679 | 12356183 | 173 | 42.40 € | 1 | 679 |
| 10013173 | 355 | 349.90 € | 1 | 693 | 12035184TW | 163 | 152.20 € | 1 | 679 | 12357173 | 173 | 36.80 € | 1 | 679 |
| 10028183 | 329 | 54.90 € | 1 | 693 | 12035403DW | 163 | 152.20 € | 1 | 679 | 12357183 | 173 | 36.80 € | 1 | 679 |
| 10029183 | 329 | 79.90 € | 1 | 693 | 12035404TW | 163 | 152.20 € | 1 | 679 | 12358173 | 173 | 36.80 € | 1 | 679 |
| 10030173 | 367 | 139.90 € | 1 | 693 | 12035553DW | 163 | 152.20 € | 1 | 679 | 12358183 | 173 | 36.80 € | 1 | 679 |
| 10030183 | 367 | 139.90 € | 1 | 693 | 12035554TW | 163 | 152.20 € | 1 | 679 | 12401073 | 167 | 114.90 € | 1 | 679 |
| 10030693 | 367 | 139.90 € | 1 | 693 | 12035753DW | 163 | 152.20 € | 1 | 679 | 12401083 | 167 | 114.90 € | 1 | 679 |
| 10033103 | 355 | 379.90 € | 1 | 693 | 12035754TW | 163 | 152.20 € | 1 | 679 | 12431173 | 167 | 59.50 € | 1 | 679 |
| 10033173 | 355 | 379.90 € | 1 | 693 | 12035853DW | 163 | 152.20 € | 1 | 679 | 12431183 | 167 | 59.50 € | 1 | 679 |
| 10034173 | 367 | 149.90 € | 1 | 693 | 12035854TW | 163 | 152.20 € | 1 | 679 | 12461073 | 157 | 79.40 € | 1 | 679 |
| 10034183 | 367 | 149.90 € | 1 | 693 | 12036173DW | 163 | 152.20 € | 1 | 679 | 12461083 | 157 | 79.40 € | 1 | 679 |
| 10034693 | 367 | 149.90 € | 1 | 693 | 12036174TW | 163 | 152.20 € | 1 | 679 | 12461253 | 157 | 84.90 € | 1 | 679 |
| 10036173 | 325 | 139.90 € | 1 | 693 | 12036183DW | 163 | 152.20 € | 1 | 679 | 12462073 | 157 | 83.30 € | 1 | 679 |
| 10036173MC | 325 | 159.90 € | 1 | 693 | 12036184TW | 163 | 152.20 € | 1 | 679 | 12462083 | 157 | 83.30 € | 1 | 679 |
| 10036183 | 325 | 139.90 € | 1 | 693 | 12036403DW | 163 | 152.20 € | 1 | 679 | 12462253 | 157 | 88.80 € | 1 | 679 |
| 10036183MC | 325 | 159.90 € | 1 | 693 | 12036404TW | 163 | 152.20 € | 1 | 679 | 12510073 | 181 | 53.60 € | 1 | 679 |
| 10037173 | 325 | 149.90 € | 1 | 693 | 12036553DW | 163 | 152.20 € | 1 | 679 | 12511073 | 181 | 68.00 € | 1 | 679 |
| 10037173MC | 325 | 169.90 € | 1 | 693 | 12036554TW | 163 | 152.20 € | 1 | 679 | 12512073 | 181 | 85.60 € | 1 | 679 |
| 10037183 | 325 | 149.90 € | 1 | 693 | 12036753DW | 163 | 152.20 € | 1 | 679 | 12513073 | 181 | 55.20 € | 1 | 679 |
| 10037183MC | 325 | 169.90 € | 1 | 693 | 12036754TW | 163 | 152.20 € | 1 | 679 | 12514073 | 181 | 74.50 € | 1 | 679 |
| 10039183 | 323 | 169.90 € | 1 | 693 | 12036853DW | 163 | 152.20 € | 1 | 679 | 12515073 | 181 | 89.90 € | 1 | 679 |

| Article no. | Page | Price in € | Discount group | Product group | Article no. | Page | Price in € | Discount group | Product group | Article no. | Page | Price in € | Discount group | Product group |
|-------------|------|------------|----------------|---------------|-------------|------|------------|----------------|---------------|-------------|------|------------|----------------|---------------|
| 12563073 | 45 | 57.80 € | 1 | 679 | 12929503 | 194 | 49.90 € | 1 | 676 | 13524164 | 119 | 1,799.90 € | 2 | 2637 |
| 12564073 | 45 | 83.90 € | 1 | 679 | 12953003 | 199 | 69.90 € | 1 | 676 | 13524173 | 119 | 1,799.90 € | 2 | 2637 |
| 12565073 | 45 | 91.20 € | 1 | 679 | 12953004 | 199 | 69.90 € | 1 | 676 | 13524174 | 119 | 1,799.90 € | 2 | 2637 |
| 12567073 | 45 | 140.40 € | 1 | 679 | 12954003 | 199 | 69.90 € | 1 | 676 | 13524183 | 119 | 1,799.90 € | 2 | 2637 |
| 12569073 | 45 | 164.40 € | 1 | 679 | 12954004 | 199 | 69.90 € | 1 | 676 | 13524184 | 119 | 1,799.90 € | 2 | 2637 |
| 12573073 | 180 | 30.90 € | 1 | 2637 | 12963383 | 198 | 64.90 € | 1 | 676 | 13525163 | 119 | 559.90 € | 2 | 2637 |
| 12574073 | 180 | 37.90 € | 1 | 2637 | 12963603 | 198 | 64.90 € | 1 | 676 | 13525164 | 119 | 559.90 € | 2 | 2637 |
| 12575073 | 180 | 44.90 € | 1 | 2637 | 12965003 | 199 | 99.90 € | 1 | 676 | 13525173 | 119 | 559.90 € | 2 | 2637 |
| 12576073 | 180 | 32.90 € | 1 | 2637 | 12981503 | 195 | 81.40 € | 1 | 676 | 13525174 | 119 | 559.90 € | 2 | 2637 |
| 12577073 | 180 | 39.90 € | 1 | 2637 | 12981503AB | 195 | 91.40 € | 1 | 679 | 13525183 | 119 | 559.90 € | 2 | 2637 |
| 12578073 | 180 | 46.90 € | 1 | 2637 | 12982503 | 195 | 86.50 € | 1 | 679 | 13525184 | 119 | 559.90 € | 2 | 2637 |
| 12646153 | 154 | 49.20 € | 1 | 679 | 12982503AB | 195 | 95.40 € | 1 | 679 | 13526163 | 119 | 2,899.90 € | 2 | 2637 |
| 12646153DW | 154 | 56.20 € | 1 | 679 | 12983003 | 200 | 119.90 € | 1 | 676 | 13526164 | 119 | 2,899.90 € | 2 | 2637 |
| 12646173 | 154 | 45.70 € | 1 | 679 | 12987503 | 196 | 102.80 € | 1 | 679 | 13526173 | 119 | 2,899.90 € | 2 | 2637 |
| 12646173DW | 154 | 52.70 € | 1 | 679 | 12987503AB | 196 | 109.80 € | 1 | 679 | 13526174 | 119 | 2,899.90 € | 2 | 2637 |
| 12646183 | 154 | 45.70 € | 1 | 679 | 12988503 | 196 | 131.10 € | 1 | 679 | 13526183 | 119 | 2,899.90 € | 2 | 2637 |
| 12646183DW | 154 | 52.70 € | 1 | 679 | 12988503AB | 196 | 136.20 € | 1 | 679 | 13526184 | 119 | 2,899.90 € | 2 | 2637 |
| 12647153 | 155 | 47.50 € | 1 | 679 | 12989503 | 197 | 159.80 € | 1 | 679 | 13527163 | 119 | 2,599.90 € | 2 | 2637 |
| 12647153DW | 155 | 54.70 € | 1 | 679 | 12989503AB | 197 | 167.80 € | 1 | 679 | 13527164 | 119 | 2,599.90 € | 2 | 2637 |
| 12647173 | 155 | 44.10 € | 1 | 679 | 13520163 | 119 | 739.90 € | 2 | 2637 | 13527173 | 119 | 2,599.90 € | 2 | 2637 |
| 12647173DW | 155 | 51.20 € | 1 | 679 | 13520164 | 119 | 739.90 € | 2 | 2637 | 13527174 | 119 | 2,599.90 € | 2 | 2637 |
| 12647183 | 155 | 44.10 € | 1 | 679 | 13520173 | 119 | 739.90 € | 2 | 2637 | 13527183 | 119 | 2,599.90 € | 2 | 2637 |
| 12647183DW | 155 | 51.20 € | 1 | 679 | 13520174 | 119 | 739.90 € | 2 | 2637 | 13527184 | 119 | 2,599.90 € | 2 | 2637 |
| 12823003 | 200 | 109.90 € | 1 | 676 | 13520183 | 119 | 739.90 € | 2 | 2637 | 13528163 | 119 | 3,499.90 € | 2 | 2637 |
| 12843004 | 200 | 109.90 € | 1 | 676 | 13520184 | 119 | 739.90 € | 2 | 2637 | 13528164 | 119 | 3,499.90 € | 2 | 2637 |
| 12920003 | 199 | 29.90 € | 1 | 676 | 13521163 | 119 | 949.90 € | 2 | 2637 | 13528173 | 119 | 3,499.90 € | 2 | 2637 |
| 12920004 | 199 | 29.90 € | 1 | 676 | 13521164 | 119 | 949.90 € | 2 | 2637 | 13528174 | 119 | 3,499.90 € | 2 | 2637 |
| 12920183 | 199 | 29.90 € | 1 | 676 | 13521173 | 119 | 949.90 € | 2 | 2637 | 13528183 | 119 | 3,499.90 € | 2 | 2637 |
| 12920184 | 199 | 29.90 € | 1 | 676 | 13521174 | 119 | 949.90 € | 2 | 2637 | 13528184 | 119 | 3,499.90 € | 2 | 2637 |
| 12920243 | 199 | 29.90 € | 1 | 676 | 13521183 | 119 | 949.90 € | 2 | 2637 | 13530163 | 119 | 899.90 € | 2 | 2637 |
| 12920244 | 199 | 29.90 € | 1 | 676 | 13521184 | 119 | 949.90 € | 2 | 2637 | 13530164 | 119 | 899.90 € | 2 | 2637 |
| 12920603 | 199 | 29.90 € | 1 | 676 | 13522163 | 119 | 1,249.90 € | 2 | 2637 | 13530173 | 119 | 899.90 € | 2 | 2637 |
| 12920604 | 199 | 29.90 € | 1 | 676 | 13522164 | 119 | 1,249.90 € | 2 | 2637 | 13530174 | 119 | 899.90 € | 2 | 2637 |
| 12923383 | 198 | 44.90 € | 1 | 676 | 13522173 | 119 | 1,249.90 € | 2 | 2637 | 13530183 | 119 | 899.90 € | 2 | 2637 |
| 12923384 | 198 | 44.90 € | 1 | 676 | 13522174 | 119 | 1,249.90 € | 2 | 2637 | 13530184 | 119 | 899.90 € | 2 | 2637 |
| 12923603 | 198 | 44.90 € | 1 | 676 | 13522183 | 119 | 1,249.90 € | 2 | 2637 | 13531163 | 119 | 1,119.90 € | 2 | 2637 |
| 12923604 | 198 | 44.90 € | 1 | 676 | 13522184 | 119 | 1,249.90 € | 2 | 2637 | 13531164 | 119 | 1,119.90 € | 2 | 2637 |
| 12924383 | 198 | 44.90 € | 1 | 676 | 13523163 | 119 | 1,499.90 € | 2 | 2637 | 13531173 | 119 | 1,119.90 € | 2 | 2637 |
| 12924384 | 198 | 44.90 € | 1 | 676 | 13523164 | 119 | 1,499.90 € | 2 | 2637 | 13531174 | 119 | 1,119.90 € | 2 | 2637 |
| 12924603 | 198 | 44.90 € | 1 | 676 | 13523173 | 119 | 1,499.90 € | 2 | 2637 | 13531183 | 119 | 1,119.90 € | 2 | 2637 |
| 12924604 | 198 | 44.90 € | 1 | 676 | 13523174 | 119 | 1,499.90 € | 2 | 2637 | 13531184 | 119 | 1,119.90 € | 2 | 2637 |
| 12925003 | 198 | 29.90 € | 1 | 676 | 13523183 | 119 | 1,499.90 € | 2 | 2637 | 13532163 | 119 | 1,339.90 € | 2 | 2637 |
| 12925004 | 198 | 29.90 € | 1 | 676 | 13523184 | 119 | 1,499.90 € | 2 | 2637 | 13532164 | 119 | 1,339.90 € | 2 | 2637 |
| 12926003 | 198 | 29.90 € | 1 | 676 | 13524163 | 119 | 1,799.90 € | 2 | 2637 | 13532173 | 119 | 1,339.90 € | 2 | 2637 |

| Article no. | Page | Price in € | Discount group | Product group | Article no. | Page | Price in € | Discount group | Product group | Article no. | Page | Price in € | Discount group | Product group |
|-------------|------|------------|----------------|---------------|-------------|------|------------|----------------|---------------|-------------|------|------------|----------------|---------------|
| 13532174 | 119 | 1,339.90 € | 2 | 2637 | 13540184 | 120 | 999.90 € | 2 | 2637 | 13548164 | 120 | 4,899.90 € | 2 | 2637 |
| 13532183 | 119 | 1,339.90 € | 2 | 2637 | 13541163 | 120 | 1,229.90 € | 2 | 2637 | 13548173 | 120 | 4,899.90 € | 2 | 2637 |
| 13532184 | 119 | 1,339.90 € | 2 | 2637 | 13541164 | 120 | 1,229.90 € | 2 | 2637 | 13548174 | 120 | 4,899.90 € | 2 | 2637 |
| 13533163 | 119 | 1,599.90 € | 2 | 2637 | 13541173 | 120 | 1,229.90 € | 2 | 2637 | 13548183 | 120 | 4,899.90 € | 2 | 2637 |
| 13533164 | 119 | 1,599.90 € | 2 | 2637 | 13541174 | 120 | 1,229.90 € | 2 | 2637 | 13548184 | 120 | 4,899.90 € | 2 | 2637 |
| 13533173 | 119 | 1,599.90 € | 2 | 2637 | 13541183 | 120 | 1,229.90 € | 2 | 2637 | 13550163 | 120 | 1,149.90 € | 2 | 2637 |
| 13533174 | 119 | 1,599.90 € | 2 | 2637 | 13541184 | 120 | 1,229.90 € | 2 | 2637 | 13550164 | 120 | 1,149.90 € | 2 | 2637 |
| 13533183 | 119 | 1,599.90 € | 2 | 2637 | 13542163 | 120 | 1,659.90 € | 2 | 2637 | 13550173 | 120 | 1,149.90 € | 2 | 2637 |
| 13533184 | 119 | 1,599.90 € | 2 | 2637 | 13542164 | 120 | 1,659.90 € | 2 | 2637 | 13550174 | 120 | 1,149.90 € | 2 | 2637 |
| 13534163 | 119 | 1,999.90 € | 2 | 2637 | 13542173 | 120 | 1,659.90 € | 2 | 2637 | 13550183 | 120 | 1,149.90 € | 2 | 2637 |
| 13534164 | 119 | 1,999.90 € | 2 | 2637 | 13542174 | 120 | 1,659.90 € | 2 | 2637 | 13550184 | 120 | 1,149.90 € | 2 | 2637 |
| 13534173 | 119 | 1,999.90 € | 2 | 2637 | 13542183 | 120 | 1,659.90 € | 2 | 2637 | 13551163 | 120 | 1,339.90 € | 2 | 2637 |
| 13534174 | 119 | 1,999.90 € | 2 | 2637 | 13542184 | 120 | 1,659.90 € | 2 | 2637 | 13551164 | 120 | 1,339.90 € | 2 | 2637 |
| 13534183 | 119 | 1,999.90 € | 2 | 2637 | 13543163 | 120 | 1,999.90 € | 2 | 2637 | 13551173 | 120 | 1,339.90 € | 2 | 2637 |
| 13534184 | 119 | 1,999.90 € | 2 | 2637 | 13543164 | 120 | 1,999.90 € | 2 | 2637 | 13551174 | 120 | 1,339.90 € | 2 | 2637 |
| 13535163 | 119 | 669.90 € | 2 | 2637 | 13543173 | 120 | 1,999.90 € | 2 | 2637 | 13551183 | 120 | 1,339.90 € | 2 | 2637 |
| 13535164 | 119 | 669.90 € | 2 | 2637 | 13543174 | 120 | 1,999.90 € | 2 | 2637 | 13551184 | 120 | 1,339.90 € | 2 | 2637 |
| 13535173 | 119 | 669.90 € | 2 | 2637 | 13543183 | 120 | 1,999.90 € | 2 | 2637 | 13552163 | 120 | 1,999.90 € | 2 | 2637 |
| 13535174 | 119 | 669.90 € | 2 | 2637 | 13543184 | 120 | 1,999.90 € | 2 | 2637 | 13552164 | 120 | 1,999.90 € | 2 | 2637 |
| 13535183 | 119 | 669.90 € | 2 | 2637 | 13544163 | 120 | 2,499.90 € | 2 | 2637 | 13552173 | 120 | 1,999.90 € | 2 | 2637 |
| 13535184 | 119 | 669.90 € | 2 | 2637 | 13544164 | 120 | 2,499.90 € | 2 | 2637 | 13552174 | 120 | 1,999.90 € | 2 | 2637 |
| 13536163 | 119 | 3,299.90 € | 2 | 2637 | 13544173 | 120 | 2,499.90 € | 2 | 2637 | 13552183 | 120 | 1,999.90 € | 2 | 2637 |
| 13536164 | 119 | 3,299.90 € | 2 | 2637 | 13544174 | 120 | 2,499.90 € | 2 | 2637 | 13552184 | 120 | 1,999.90 € | 2 | 2637 |
| 13536173 | 119 | 3,299.90 € | 2 | 2637 | 13544183 | 120 | 2,499.90 € | 2 | 2637 | 13553163 | 120 | 2,199.90 € | 2 | 2637 |
| 13536174 | 119 | 3,299.90 € | 2 | 2637 | 13544184 | 120 | 2,499.90 € | 2 | 2637 | 13553164 | 120 | 2,199.90 € | 2 | 2637 |
| 13536183 | 119 | 3,299.90 € | 2 | 2637 | 13545163 | 120 | 789.90 € | 2 | 2637 | 13553173 | 120 | 2,199.90 € | 2 | 2637 |
| 13536184 | 119 | 3,299.90 € | 2 | 2637 | 13545164 | 120 | 789.90 € | 2 | 2637 | 13553174 | 120 | 2,199.90 € | 2 | 2637 |
| 13537163 | 119 | 2,899.90 € | 2 | 2637 | 13545173 | 120 | 789.90 € | 2 | 2637 | 13553183 | 120 | 2,199.90 € | 2 | 2637 |
| 13537164 | 119 | 2,899.90 € | 2 | 2637 | 13545174 | 120 | 789.90 € | 2 | 2637 | 13553184 | 120 | 2,199.90 € | 2 | 2637 |
| 13537173 | 119 | 2,899.90 € | 2 | 2637 | 13545183 | 120 | 789.90 € | 2 | 2637 | 13554163 | 120 | 2,799.90 € | 2 | 2637 |
| 13537174 | 119 | 2,899.90 € | 2 | 2637 | 13545184 | 120 | 789.90 € | 2 | 2637 | 13554164 | 120 | 2,799.90 € | 2 | 2637 |
| 13537183 | 119 | 2,899.90 € | 2 | 2637 | 13546163 | 120 | 3,999.90 € | 2 | 2637 | 13554173 | 120 | 2,799.90 € | 2 | 2637 |
| 13537184 | 119 | 2,899.90 € | 2 | 2637 | 13546164 | 120 | 3,999.90 € | 2 | 2637 | 13554174 | 120 | 2,799.90 € | 2 | 2637 |
| 13538163 | 119 | 3,999.90 € | 2 | 2637 | 13546173 | 120 | 3,999.90 € | 2 | 2637 | 13554183 | 120 | 2,799.90 € | 2 | 2637 |
| 13538164 | 119 | 3,999.90 € | 2 | 2637 | 13546174 | 120 | 3,999.90 € | 2 | 2637 | 13554184 | 120 | 2,799.90 € | 2 | 2637 |
| 13538173 | 119 | 3,999.90 € | 2 | 2637 | 13546183 | 120 | 3,999.90 € | 2 | 2637 | 13555163 | 120 | 899.90 € | 2 | 2637 |
| 13538174 | 119 | 3,999.90 € | 2 | 2637 | 13546184 | 120 | 3,999.90 € | 2 | 2637 | 13555164 | 120 | 899.90 € | 2 | 2637 |
| 13538183 | 119 | 3,999.90 € | 2 | 2637 | 13547163 | 120 | 3,699.90 € | 2 | 2637 | 13555173 | 120 | 899.90 € | 2 | 2637 |
| 13538184 | 119 | 3,999.90 € | 2 | 2637 | 13547164 | 120 | 3,699.90 € | 2 | 2637 | 13555174 | 120 | 899.90 € | 2 | 2637 |
| 13540163 | 120 | 999.90 € | 2 | 2637 | 13547173 | 120 | 3,699.90 € | 2 | 2637 | 13555183 | 120 | 899.90 € | 2 | 2637 |
| 13540164 | 120 | 999.90 € | 2 | 2637 | 13547174 | 120 | 3,699.90 € | 2 | 2637 | 13555184 | 120 | 899.90 € | 2 | 2637 |
| 13540173 | 120 | 999.90 € | 2 | 2637 | 13547183 | 120 | 3,699.90 € | 2 | 2637 | 13556163 | 120 | 4,799.90 € | 2 | 2637 |
| 13540174 | 120 | 999.90 € | 2 | 2637 | 13547184 | 120 | 3,699.90 € | 2 | 2637 | 13556164 | 120 | 4,799.90 € | 2 | 2637 |
| 13540183 | 120 | 999.90 € | 2 | 2637 | 13548163 | 120 | 4,899.90 € | 2 | 2637 | 13556173 | 120 | 4,799.90 € | 2 | 2637 |

| Article no. | Page | Price in € | Discount group | Product group | Article no. | Page | Price in € | Discount group | Product group | Article no. | Page | Price in € | Discount group | Product group |
|-------------|------|------------|----------------|---------------|-------------|------|------------|----------------|---------------|-------------|------|------------|----------------|---------------|
| 13556174 | 120 | 4,799.90 € | 2 | 2637 | 13564184 | 118 | 1,999.90 € | 2 | 2637 | 13573164 | 118 | 1,799.90 € | 2 | 2637 |
| 13556183 | 120 | 4,799.90 € | 2 | 2637 | 13565163 | 118 | 569.90 € | 2 | 2637 | 13573173 | 118 | 1,799.90 € | 2 | 2637 |
| 13556184 | 120 | 4,799.90 € | 2 | 2637 | 13565164 | 118 | 569.90 € | 2 | 2637 | 13573174 | 118 | 1,799.90 € | 2 | 2637 |
| 13557163 | 120 | 4,399.90 € | 2 | 2637 | 13565173 | 118 | 569.90 € | 2 | 2637 | 13573183 | 118 | 1,799.90 € | 2 | 2637 |
| 13557164 | 120 | 4,399.90 € | 2 | 2637 | 13565174 | 118 | 569.90 € | 2 | 2637 | 13573184 | 118 | 1,799.90 € | 2 | 2637 |
| 13557173 | 120 | 4,399.90 € | 2 | 2637 | 13565183 | 118 | 569.90 € | 2 | 2637 | 13574163 | 118 | 2,199.90 € | 2 | 2637 |
| 13557174 | 120 | 4,399.90 € | 2 | 2637 | 13565184 | 118 | 569.90 € | 2 | 2637 | 13574164 | 118 | 2,199.90 € | 2 | 2637 |
| 13557183 | 120 | 4,399.90 € | 2 | 2637 | 13566163 | 118 | 2,999.90 € | 2 | 2637 | 13574173 | 118 | 2,199.90 € | 2 | 2637 |
| 13557184 | 120 | 4,399.90 € | 2 | 2637 | 13566164 | 118 | 2,999.90 € | 2 | 2637 | 13574174 | 118 | 2,199.90 € | 2 | 2637 |
| 13558163 | 120 | 5,999.90 € | 2 | 2637 | 13566173 | 118 | 2,999.90 € | 2 | 2637 | 13574183 | 118 | 2,199.90 € | 2 | 2637 |
| 13558164 | 120 | 5,999.90 € | 2 | 2637 | 13566174 | 118 | 2,999.90 € | 2 | 2637 | 13574184 | 118 | 2,199.90 € | 2 | 2637 |
| 13558173 | 120 | 5,999.90 € | 2 | 2637 | 13566183 | 118 | 2,999.90 € | 2 | 2637 | 13575163 | 118 | 669.90 € | 2 | 2637 |
| 13558174 | 120 | 5,999.90 € | 2 | 2637 | 13566184 | 118 | 2,999.90 € | 2 | 2637 | 13575164 | 118 | 669.90 € | 2 | 2637 |
| 13558183 | 120 | 5,999.90 € | 2 | 2637 | 13567163 | 118 | 2,799.90 € | 2 | 2637 | 13575173 | 118 | 669.90 € | 2 | 2637 |
| 13558184 | 120 | 5,999.90 € | 2 | 2637 | 13567164 | 118 | 2,799.90 € | 2 | 2637 | 13575174 | 118 | 669.90 € | 2 | 2637 |
| 13560163 | 118 | 789.90 € | 2 | 2637 | 13567173 | 118 | 2,799.90 € | 2 | 2637 | 13575183 | 118 | 669.90 € | 2 | 2637 |
| 13560164 | 118 | 789.90 € | 2 | 2637 | 13567174 | 118 | 2,799.90 € | 2 | 2637 | 13575184 | 118 | 669.90 € | 2 | 2637 |
| 13560173 | 118 | 789.90 € | 2 | 2637 | 13567183 | 118 | 2,799.90 € | 2 | 2637 | 13576163 | 118 | 3,399.90 € | 2 | 2637 |
| 13560174 | 118 | 789.90 € | 2 | 2637 | 13567184 | 118 | 2,799.90 € | 2 | 2637 | 13576164 | 118 | 3,399.90 € | 2 | 2637 |
| 13560183 | 118 | 789.90 € | 2 | 2637 | 13568163 | 118 | 3,699.90 € | 2 | 2637 | 13576173 | 118 | 3,399.90 € | 2 | 2637 |
| 13560184 | 118 | 789.90 € | 2 | 2637 | 13568164 | 118 | 3,699.90 € | 2 | 2637 | 13576174 | 118 | 3,399.90 € | 2 | 2637 |
| 13561163 | 118 | 1,009.90 € | 2 | 2637 | 13568173 | 118 | 3,699.90 € | 2 | 2637 | 13576183 | 118 | 3,399.90 € | 2 | 2637 |
| 13561164 | 118 | 1,009.90 € | 2 | 2637 | 13568174 | 118 | 3,699.90 € | 2 | 2637 | 13576184 | 118 | 3,399.90 € | 2 | 2637 |
| 13561173 | 118 | 1,009.90 € | 2 | 2637 | 13568183 | 118 | 3,699.90 € | 2 | 2637 | 13577163 | 118 | 2,999.90 € | 2 | 2637 |
| 13561174 | 118 | 1,009.90 € | 2 | 2637 | 13568184 | 118 | 3,699.90 € | 2 | 2637 | 13577164 | 118 | 2,999.90 € | 2 | 2637 |
| 13561183 | 118 | 1,009.90 € | 2 | 2637 | 13570163 | 118 | 899.90 € | 2 | 2637 | 13577173 | 118 | 2,999.90 € | 2 | 2637 |
| 13561184 | 118 | 1,009.90 € | 2 | 2637 | 13570164 | 118 | 899.90 € | 2 | 2637 | 13577174 | 118 | 2,999.90 € | 2 | 2637 |
| 13562163 | 118 | 1,299.90 € | 2 | 2637 | 13570173 | 118 | 899.90 € | 2 | 2637 | 13577183 | 118 | 2,999.90 € | 2 | 2637 |
| 13562164 | 118 | 1,299.90 € | 2 | 2637 | 13570174 | 118 | 899.90 € | 2 | 2637 | 13577184 | 118 | 2,999.90 € | 2 | 2637 |
| 13562173 | 118 | 1,299.90 € | 2 | 2637 | 13570183 | 118 | 899.90 € | 2 | 2637 | 13578163 | 118 | 3,999.90 € | 2 | 2637 |
| 13562174 | 118 | 1,299.90 € | 2 | 2637 | 13570184 | 118 | 899.90 € | 2 | 2637 | 13578164 | 118 | 3,999.90 € | 2 | 2637 |
| 13562183 | 118 | 1,299.90 € | 2 | 2637 | 13571163 | 118 | 1,119.90 € | 2 | 2637 | 13578173 | 118 | 3,999.90 € | 2 | 2637 |
| 13562184 | 118 | 1,299.90 € | 2 | 2637 | 13571164 | 118 | 1,119.90 € | 2 | 2637 | 13578174 | 118 | 3,999.90 € | 2 | 2637 |
| 13563163 | 118 | 1,599.90 € | 2 | 2637 | 13571173 | 118 | 1,119.90 € | 2 | 2637 | 13578183 | 118 | 3,999.90 € | 2 | 2637 |
| 13563164 | 118 | 1,599.90 € | 2 | 2637 | 13571174 | 118 | 1,119.90 € | 2 | 2637 | 13578184 | 118 | 3,999.90 € | 2 | 2637 |
| 13563173 | 118 | 1,599.90 € | 2 | 2637 | 13571183 | 118 | 1,119.90 € | 2 | 2637 | 13820163 | 116 | 739.90 € | 2 | 2637 |
| 13563174 | 118 | 1,599.90 € | 2 | 2637 | 13571184 | 118 | 1,119.90 € | 2 | 2637 | 13820164 | 116 | 739.90 € | 2 | 2637 |
| 13563183 | 118 | 1,599.90 € | 2 | 2637 | 13572163 | 118 | 1,399.90 € | 2 | 2637 | 13820173 | 116 | 739.90 € | 2 | 2637 |
| 13563184 | 118 | 1,599.90 € | 2 | 2637 | 13572164 | 118 | 1,399.90 € | 2 | 2637 | 13820174 | 116 | 739.90 € | 2 | 2637 |
| 13564163 | 118 | 1,999.90 € | 2 | 2637 | 13572173 | 118 | 1,399.90 € | 2 | 2637 | 13820183 | 116 | 739.90 € | 2 | 2637 |
| 13564164 | 118 | 1,999.90 € | 2 | 2637 | 13572174 | 118 | 1,399.90 € | 2 | 2637 | 13820184 | 116 | 739.90 € | 2 | 2637 |
| 13564173 | 118 | 1,999.90 € | 2 | 2637 | 13572183 | 118 | 1,399.90 € | 2 | 2637 | 13821163 | 116 | 949.90 € | 2 | 2637 |
| 13564174 | 118 | 1,999.90 € | 2 | 2637 | 13572184 | 118 | 1,399.90 € | 2 | 2637 | 13821164 | 116 | 949.90 € | 2 | 2637 |
| 13564183 | 118 | 1,999.90 € | 2 | 2637 | 13573163 | 118 | 1,799.90 € | 2 | 2637 | 13821173 | 116 | 949.90 € | 2 | 2637 |

| Article no. | Page | Price in € | Discount group | Product group | Article no. | Page | Price in € | Discount group | Product group | Article no. | Page | Price in € | Discount group | Product group |
|-------------|------|------------|----------------|---------------|-------------|------|------------|----------------|---------------|-------------|------|------------|----------------|---------------|
| 13821174 | 116 | 949.90 € | 2 | 2637 | 13830184 | 116 | 899.90 € | 2 | 2637 | 13840164 | 117 | 1,009.90 € | 2 | 2637 |
| 13821183 | 116 | 949.90 € | 2 | 2637 | 13831163 | 116 | 1,099.90 € | 2 | 2637 | 13840173 | 117 | 1,009.90 € | 2 | 2637 |
| 13821184 | 116 | 949.90 € | 2 | 2637 | 13831164 | 116 | 1,099.90 € | 2 | 2637 | 13840174 | 117 | 1,009.90 € | 2 | 2637 |
| 13822163 | 116 | 1,299.90 € | 2 | 2637 | 13831173 | 116 | 1,099.90 € | 2 | 2637 | 13840183 | 117 | 1,009.90 € | 2 | 2637 |
| 13822164 | 116 | 1,299.90 € | 2 | 2637 | 13831174 | 116 | 1,099.90 € | 2 | 2637 | 13840184 | 117 | 1,009.90 € | 2 | 2637 |
| 13822173 | 116 | 1,299.90 € | 2 | 2637 | 13831183 | 116 | 1,099.90 € | 2 | 2637 | 13841163 | 117 | 1,229.90 € | 2 | 2637 |
| 13822174 | 116 | 1,299.90 € | 2 | 2637 | 13831184 | 116 | 1,099.90 € | 2 | 2637 | 13841164 | 117 | 1,229.90 € | 2 | 2637 |
| 13822183 | 116 | 1,299.90 € | 2 | 2637 | 13832163 | 116 | 1,399.90 € | 2 | 2637 | 13841173 | 117 | 1,229.90 € | 2 | 2637 |
| 13822184 | 116 | 1,299.90 € | 2 | 2637 | 13832164 | 116 | 1,399.90 € | 2 | 2637 | 13841174 | 117 | 1,229.90 € | 2 | 2637 |
| 13823163 | 116 | 1,599.90 € | 2 | 2637 | 13832173 | 116 | 1,399.90 € | 2 | 2637 | 13841183 | 117 | 1,229.90 € | 2 | 2637 |
| 13823164 | 116 | 1,599.90 € | 2 | 2637 | 13832174 | 116 | 1,399.90 € | 2 | 2637 | 13841184 | 117 | 1,229.90 € | 2 | 2637 |
| 13823173 | 116 | 1,599.90 € | 2 | 2637 | 13832183 | 116 | 1,399.90 € | 2 | 2637 | 13842163 | 117 | 1,699.90 € | 2 | 2637 |
| 13823174 | 116 | 1,599.90 € | 2 | 2637 | 13832184 | 116 | 1,399.90 € | 2 | 2637 | 13842164 | 117 | 1,699.90 € | 2 | 2637 |
| 13823183 | 116 | 1,599.90 € | 2 | 2637 | 13833163 | 116 | 1,699.90 € | 2 | 2637 | 13842173 | 117 | 1,699.90 € | 2 | 2637 |
| 13823184 | 116 | 1,599.90 € | 2 | 2637 | 13833164 | 116 | 1,699.90 € | 2 | 2637 | 13842174 | 117 | 1,699.90 € | 2 | 2637 |
| 13824163 | 116 | 1,999.90 € | 2 | 2637 | 13833173 | 116 | 1,699.90 € | 2 | 2637 | 13842183 | 117 | 1,699.90 € | 2 | 2637 |
| 13824164 | 116 | 1,999.90 € | 2 | 2637 | 13833174 | 116 | 1,699.90 € | 2 | 2637 | 13842184 | 117 | 1,699.90 € | 2 | 2637 |
| 13824173 | 116 | 1,999.90 € | 2 | 2637 | 13833183 | 116 | 1,699.90 € | 2 | 2637 | 13843163 | 117 | 1,999.90 € | 2 | 2637 |
| 13824174 | 116 | 1,999.90 € | 2 | 2637 | 13833184 | 116 | 1,699.90 € | 2 | 2637 | 13843164 | 117 | 1,999.90 € | 2 | 2637 |
| 13824183 | 116 | 1,999.90 € | 2 | 2637 | 13834163 | 116 | 2,199.90 € | 2 | 2637 | 13843173 | 117 | 1,999.90 € | 2 | 2637 |
| 13824184 | 116 | 1,999.90 € | 2 | 2637 | 13834164 | 116 | 2,199.90 € | 2 | 2637 | 13843174 | 117 | 1,999.90 € | 2 | 2637 |
| 13825163 | 116 | 569.90 € | 2 | 2637 | 13834173 | 116 | 2,199.90 € | 2 | 2637 | 13843183 | 117 | 1,999.90 € | 2 | 2637 |
| 13825164 | 116 | 569.90 € | 2 | 2637 | 13834174 | 116 | 2,199.90 € | 2 | 2637 | 13843184 | 117 | 1,999.90 € | 2 | 2637 |
| 13825173 | 116 | 569.90 € | 2 | 2637 | 13834183 | 116 | 2,199.90 € | 2 | 2637 | 13844163 | 117 | 2,699.90 € | 2 | 2637 |
| 13825174 | 116 | 569.90 € | 2 | 2637 | 13834184 | 116 | 2,199.90 € | 2 | 2637 | 13844164 | 117 | 2,699.90 € | 2 | 2637 |
| 13825183 | 116 | 569.90 € | 2 | 2637 | 13835163 | 116 | 669.90 € | 2 | 2637 | 13844173 | 117 | 2,699.90 € | 2 | 2637 |
| 13825184 | 116 | 569.90 € | 2 | 2637 | 13835164 | 116 | 669.90 € | 2 | 2637 | 13844174 | 117 | 2,699.90 € | 2 | 2637 |
| 13826163 | 116 | 2,999.90 € | 2 | 2637 | 13835173 | 116 | 669.90 € | 2 | 2637 | 13844183 | 117 | 2,699.90 € | 2 | 2637 |
| 13826164 | 116 | 2,999.90 € | 2 | 2637 | 13835174 | 116 | 669.90 € | 2 | 2637 | 13844184 | 117 | 2,699.90 € | 2 | 2637 |
| 13826173 | 116 | 2,999.90 € | 2 | 2637 | 13835183 | 116 | 669.90 € | 2 | 2637 | 13845163 | 117 | 789.90 € | 2 | 2637 |
| 13826174 | 116 | 2,999.90 € | 2 | 2637 | 13835184 | 116 | 669.90 € | 2 | 2637 | 13845164 | 117 | 789.90 € | 2 | 2637 |
| 13826183 | 116 | 2,999.90 € | 2 | 2637 | 13836163 | 116 | 3,399.90 € | 2 | 2637 | 13845173 | 117 | 789.90 € | 2 | 2637 |
| 13826184 | 116 | 2,999.90 € | 2 | 2637 | 13836164 | 116 | 3,399.90 € | 2 | 2637 | 13845174 | 117 | 789.90 € | 2 | 2637 |
| 13827163 | 116 | 2,799.90 € | 2 | 2637 | 13836173 | 116 | 3,399.90 € | 2 | 2637 | 13845183 | 117 | 789.90 € | 2 | 2637 |
| 13827164 | 116 | 2,799.90 € | 2 | 2637 | 13836174 | 116 | 3,399.90 € | 2 | 2637 | 13845184 | 117 | 789.90 € | 2 | 2637 |
| 13827173 | 116 | 2,799.90 € | 2 | 2637 | 13836183 | 116 | 3,399.90 € | 2 | 2637 | 13846163 | 117 | 3,999.90 € | 2 | 2637 |
| 13827174 | 116 | 2,799.90 € | 2 | 2637 | 13836184 | 116 | 3,399.90 € | 2 | 2637 | 13846164 | 117 | 3,999.90 € | 2 | 2637 |
| 13827183 | 116 | 2,799.90 € | 2 | 2637 | 13837163 | 116 | 2,999.90 € | 2 | 2637 | 13846173 | 117 | 3,999.90 € | 2 | 2637 |
| 13827184 | 116 | 2,799.90 € | 2 | 2637 | 13837164 | 116 | 2,999.90 € | 2 | 2637 | 13846174 | 117 | 3,999.90 € | 2 | 2637 |
| 13830163 | 116 | 899.90 € | 2 | 2637 | 13837173 | 116 | 2,999.90 € | 2 | 2637 | 13846183 | 117 | 3,999.90 € | 2 | 2637 |
| 13830164 | 116 | 899.90 € | 2 | 2637 | 13837174 | 116 | 2,999.90 € | 2 | 2637 | 13846184 | 117 | 3,999.90 € | 2 | 2637 |
| 13830173 | 116 | 899.90 € | 2 | 2637 | 13837183 | 116 | 2,999.90 € | 2 | 2637 | 13847163 | 117 | 3,699.90 € | 2 | 2637 |
| 13830174 | 116 | 899.90 € | 2 | 2637 | 13837184 | 116 | 2,999.90 € | 2 | 2637 | 13847164 | 117 | 3,699.90 € | 2 | 2637 |
| 13830183 | 116 | 899.90 € | 2 | 2637 | 13840163 | 117 | 1,009.90 € | 2 | 2637 | 13847173 | 117 | 3,699.90 € | 2 | 2637 |

| Article no. | Page | Price in € | Discount group | Product group | Article no. | Page | Price in € | Discount group | Product group | Article no. | Page | Price in € | Discount group | Product group |
|-------------|------|------------|----------------|---------------|-------------|------|------------|----------------|---------------|-------------|------|------------|----------------|---------------|
| 13847174 | 117 | 3,699.90 € | 2 | 2637 | 13856184 | 117 | 4,799.90 € | 2 | 2637 | 13925184 | 115 | 599.90 € | 2 | 2637 |
| 13847183 | 117 | 3,699.90 € | 2 | 2637 | 13857163 | 117 | 4,499.90 € | 2 | 2637 | 13930163 | 115 | 899.90 € | 2 | 2637 |
| 13847184 | 117 | 3,699.90 € | 2 | 2637 | 13857164 | 117 | 4,499.90 € | 2 | 2637 | 13930164 | 115 | 899.90 € | 2 | 2637 |
| 13850163 | 117 | 1,119.90 € | 2 | 2637 | 13857173 | 117 | 4,499.90 € | 2 | 2637 | 13930173 | 115 | 899.90 € | 2 | 2637 |
| 13850164 | 117 | 1,119.90 € | 2 | 2637 | 13857174 | 117 | 4,499.90 € | 2 | 2637 | 13930174 | 115 | 899.90 € | 2 | 2637 |
| 13850173 | 117 | 1,119.90 € | 2 | 2637 | 13857183 | 117 | 4,499.90 € | 2 | 2637 | 13930183 | 115 | 899.90 € | 2 | 2637 |
| 13850174 | 117 | 1,119.90 € | 2 | 2637 | 13857184 | 117 | 4,499.90 € | 2 | 2637 | 13930184 | 115 | 899.90 € | 2 | 2637 |
| 13850183 | 117 | 1,119.90 € | 2 | 2637 | 13920163 | 115 | 789.90 € | 2 | 2637 | 13931163 | 115 | 1,199.90 € | 2 | 2637 |
| 13850184 | 117 | 1,119.90 € | 2 | 2637 | 13920164 | 115 | 789.90 € | 2 | 2637 | 13931164 | 115 | 1,199.90 € | 2 | 2637 |
| 13851163 | 117 | 1,339.90 € | 2 | 2637 | 13920173 | 115 | 789.90 € | 2 | 2637 | 13931173 | 115 | 1,199.90 € | 2 | 2637 |
| 13851164 | 117 | 1,339.90 € | 2 | 2637 | 13920174 | 115 | 789.90 € | 2 | 2637 | 13931174 | 115 | 1,199.90 € | 2 | 2637 |
| 13851173 | 117 | 1,339.90 € | 2 | 2637 | 13920183 | 115 | 789.90 € | 2 | 2637 | 13931183 | 115 | 1,119.90 € | 2 | 2637 |
| 13851174 | 117 | 1,339.90 € | 2 | 2637 | 13920184 | 115 | 789.90 € | 2 | 2637 | 13931184 | 115 | 1,119.90 € | 2 | 2637 |
| 13851183 | 117 | 1,339.90 € | 2 | 2637 | 13921163 | 115 | 1,009.90 € | 2 | 2637 | 13932163 | 115 | 1,499.90 € | 2 | 2637 |
| 13851184 | 117 | 1,339.90 € | 2 | 2637 | 13921164 | 115 | 1,009.90 € | 2 | 2637 | 13932164 | 115 | 1,499.90 € | 2 | 2637 |
| 13852163 | 117 | 1,999.90 € | 2 | 2637 | 13921173 | 115 | 1,009.90 € | 2 | 2637 | 13932173 | 115 | 1,499.90 € | 2 | 2637 |
| 13852164 | 117 | 1,999.90 € | 2 | 2637 | 13921174 | 115 | 1,009.90 € | 2 | 2637 | 13932174 | 115 | 1,499.90 € | 2 | 2637 |
| 13852173 | 117 | 1,999.90 € | 2 | 2637 | 13921183 | 115 | 1,009.90 € | 2 | 2637 | 13932183 | 115 | 1,499.90 € | 2 | 2637 |
| 13852174 | 117 | 1,999.90 € | 2 | 2637 | 13921184 | 115 | 1,009.90 € | 2 | 2637 | 13932184 | 115 | 1,499.90 € | 2 | 2637 |
| 13852183 | 117 | 1,999.90 € | 2 | 2637 | 13922163 | 115 | 1,399.90 € | 2 | 2637 | 13933163 | 115 | 1,799.90 € | 2 | 2637 |
| 13852184 | 117 | 1,999.90 € | 2 | 2637 | 13922164 | 115 | 1,399.90 € | 2 | 2637 | 13933164 | 115 | 1,799.90 € | 2 | 2637 |
| 13853163 | 117 | 2,299.90 € | 2 | 2637 | 13922173 | 115 | 1,399.90 € | 2 | 2637 | 13933173 | 115 | 1,799.90 € | 2 | 2637 |
| 13853164 | 117 | 2,299.90 € | 2 | 2637 | 13922174 | 115 | 1,399.90 € | 2 | 2637 | 13933174 | 115 | 1,799.90 € | 2 | 2637 |
| 13853173 | 117 | 2,299.90 € | 2 | 2637 | 13922183 | 115 | 1,399.90 € | 2 | 2637 | 13933183 | 115 | 1,799.90 € | 2 | 2637 |
| 13853174 | 117 | 2,299.90 € | 2 | 2637 | 13922184 | 115 | 1,399.90 € | 2 | 2637 | 13933184 | 115 | 1,799.90 € | 2 | 2637 |
| 13853183 | 117 | 2,299.90 € | 2 | 2637 | 13923163 | 115 | 1,699.90 € | 2 | 2637 | 13935163 | 115 | 799.90 € | 2 | 2637 |
| 13853184 | 117 | 2,299.90 € | 2 | 2637 | 13923164 | 115 | 1,699.90 € | 2 | 2637 | 13935164 | 115 | 799.90 € | 2 | 2637 |
| 13854163 | 117 | 2,899.90 € | 2 | 2637 | 13923173 | 115 | 1,699.90 € | 2 | 2637 | 13935173 | 115 | 799.90 € | 2 | 2637 |
| 13854164 | 117 | 2,899.90 € | 2 | 2637 | 13923174 | 115 | 1,699.90 € | 2 | 2637 | 13935174 | 115 | 799.90 € | 2 | 2637 |
| 13854173 | 117 | 2,899.90 € | 2 | 2637 | 13923183 | 115 | 1,699.90 € | 2 | 2637 | 13935183 | 103 | 799.90 € | 2 | 2637 |
| 13854174 | 117 | 2,899.90 € | 2 | 2637 | 13923184 | 115 | 1,699.90 € | 2 | 2637 | 13935183 | 103 | 799.90 € | 2 | 2637 |
| 13854183 | 117 | 2,899.90 € | 2 | 2637 | 13925163 | 115 | 599.90 € | 2 | 2637 | 13935183 | 115 | 799.90 € | 2 | 2637 |
| 13854184 | 117 | 2,899.90 € | 2 | 2637 | 13925164 | 115 | 599.90 € | 2 | 2637 | 13935184 | 103 | 799.90 € | 2 | 2637 |
| 13855163 | 117 | 899.90 € | 2 | 2637 | 13925173 | 115 | 599.90 € | 2 | 2637 | 13935184 | 103 | 799.90 € | 2 | 2637 |
| 13855164 | 117 | 899.90 € | 2 | 2637 | 13925174 | 115 | 599.90 € | 2 | 2637 | 13935184 | 115 | 799.90 € | 2 | 2637 |
| 13855173 | 117 | 899.90 € | 2 | 2637 | 13925183 | 103 | 599.90 € | 2 | 2637 | 14011223 | 390 | 64.90 € | 1 | 679 |
| 13855174 | 117 | 899.90 € | 2 | 2637 | 13925183 | 103 | 599.90 € | 2 | 2637 | 14035223 | 386 | 222.90 € | 1 | 693 |
| 13855183 | 117 | 899.90 € | 2 | 2637 | 13925183 | 103 | 599.90 € | 2 | 2637 | 14036223 | 386 | 279.90 € | 1 | 693 |
| 13855184 | 117 | 899.90 € | 2 | 2637 | 13925183 | 103 | 599.90 € | 2 | 2637 | 14037223 | 386 | 190.90 € | 1 | 693 |
| 13856163 | 117 | 4,799.90 € | 2 | 2637 | 13925183 | 115 | 599.90 € | 2 | 2637 | 14050223 | 387 | 132.90 € | 1 | 693 |
| 13856164 | 117 | 4,799.90 € | 2 | 2637 | 13925184 | 103 | 599.90 € | 2 | 2637 | 14051223 | 387 | 134.90 € | 1 | 693 |
| 13856173 | 117 | 4,799.90 € | 2 | 2637 | 13925184 | 103 | 599.90 € | 2 | 2637 | 14052223 | 389 | 217.90 € | 1 | 693 |
| 13856174 | 117 | 4,799.90 € | 2 | 2637 | 13925184 | 103 | 599.90 € | 2 | 2637 | 14053223 | 389 | 299.90 € | 1 | 693 |
| 13856183 | 117 | 4,799.90 € | 2 | 2637 | 13925184 | 103 | 599.90 € | 2 | 2637 | 14054223 | 389 | 309.90 € | 1 | 693 |

| Article no. | Page | Price in € | Discount group | Product group | Article no. | Page | Price in € | Discount group | Product group | Article no. | Page | Price in € | Discount group | Product group |
|-------------|------|------------|----------------|---------------|-------------|------|------------|----------------|---------------|-------------|------|------------|----------------|---------------|
| 14665223 | 383 | 249.90 € | 1 | 693 | 15571003 | 236 | 159.00 € | 1 | 680 | 17663000 | 202 | 36.60 € | 1 | 678 |
| 14666223 | 383 | 389.90 € | 1 | 693 | 15571004 | 236 | 159.00 € | 1 | 680 | 17663010 | 202 | 34.30 € | 1 | 678 |
| 14667223 | 383 | 479.90 € | 1 | 693 | 15571027 | 236 | 159.00 € | 1 | 680 | 17663020 | 202 | 45.50 € | 1 | 678 |
| 14674223 | 383 | 259.90 € | 1 | 693 | 15572003 | 237 | 179.00 € | 1 | 680 | 17684000 | 203 | 81.20 € | 1 | 678 |
| 14675223 | 383 | 399.90 € | 1 | 693 | 15572004 | 237 | 179.00 € | 1 | 680 | 17684010 | 203 | 75.90 € | 1 | 678 |
| 14676223 | 383 | 489.90 € | 1 | 693 | 15572027 | 237 | 179.00 € | 1 | 680 | 17684020 | 203 | 86.30 € | 1 | 678 |
| 14685083 | 385 | 219.90 € | 1 | 693 | 15573003 | 238 | 199.00 € | 1 | 680 | 18151000 | 268 | 499.90 € | 1 | 678 |
| 14686083 | 385 | 359.90 € | 1 | 693 | 15573004 | 238 | 199.00 € | 1 | 680 | 18152000 | 268 | 149.90 € | 1 | 678 |
| 14687083 | 385 | 449.90 € | 1 | 693 | 15573027 | 238 | 199.00 € | 1 | 680 | 18153000 | 268 | 129.90 € | 1 | 678 |
| 14694083 | 385 | 229.90 € | 1 | 693 | 15574003 | 239 | 229.00 € | 1 | 680 | 18154000 | 268 | 129.90 € | 1 | 678 |
| 14695083 | 385 | 369.90 € | 1 | 693 | 15574004 | 239 | 229.00 € | 1 | 680 | 18155000 | 268 | 154.90 € | 1 | 678 |
| 14696083 | 385 | 459.90 € | 1 | 693 | 15574027 | 239 | 229.00 € | 1 | 680 | 18156000 | 272 | 269.90 € | 1 | 678 |
| 15316004 | 242 | 239.00 € | 1 | 680 | 15666003 | 240 | 239.00 € | 1 | 680 | 18157000 | 273 | 127.90 € | 1 | 678 |
| 15317003 | 241 | 169.00 € | 1 | 680 | 15666027 | 240 | 239.00 € | 1 | 680 | 18161000 | 268 | 499.90 € | 1 | 678 |
| 15317004 | 241 | 169.00 € | 1 | 680 | 17224000 | 264 | 149.90 € | 1 | 678 | 18162000 | 268 | 149.90 € | 1 | 678 |
| 15317027 | 241 | 169.00 € | 1 | 680 | 17225000 | 264 | 159.90 € | 1 | 678 | 18164000 | 268 | 127.90 € | 1 | 678 |
| 15376004 | 242 | 259.00 € | 1 | 680 | 17226000 | 264 | 209.90 € | 1 | 678 | 18165000 | 268 | 154.90 € | 1 | 678 |
| 15377003 | 241 | 229.00 € | 1 | 680 | 17227000 | 265 | 299.90 € | 1 | 678 | 18170000 | 278 | 207.90 € | 1 | 678 |
| 15377004 | 241 | 229.00 € | 1 | 680 | 17228000 | 265 | 399.90 € | 1 | 678 | 18190000 | 276 | 190.90 € | 1 | 678 |
| 15377027 | 241 | 229.00 € | 1 | 680 | 17230000 | 266 | 64.90 € | 1 | 678 | 18192000 | 280 | 164.90 € | 1 | 678 |
| 15501003 | 236 | 99.00 € | 1 | 680 | 17231000 | 266 | 119.90 € | 1 | 678 | 18194070 | 283 | 174.90 € | 1 | 678 |
| 15501004 | 236 | 99.00 € | 1 | 680 | 17232000 | 266 | 139.90 € | 1 | 678 | 18194080 | 283 | 174.90 € | 1 | 678 |
| 15501027 | 236 | 99.00 € | 1 | 680 | 17240000 | 262 | 29.90 € | 1 | 678 | 18195000 | 280 | 86.90 € | 1 | 678 |
| 15502003 | 237 | 109.00 € | 1 | 680 | 17241000 | 262 | 39.90 € | 1 | 678 | 18196000 | 283 | 185.90 € | 1 | 678 |
| 15502004 | 237 | 109.00 € | 1 | 680 | 17242000 | 262 | 49.90 € | 1 | 678 | 18197000 | 282 | 169.90 € | 1 | 678 |
| 15502027 | 237 | 109.00 € | 1 | 680 | 17243000 | 262 | 79.90 € | 1 | 678 | 18198000 | 281 | 148.90 € | 1 | 678 |
| 15503003 | 238 | 129.00 € | 1 | 680 | 17244000 | 263 | 89.90 € | 1 | 678 | 18199000 | 281 | 137.70 € | 1 | 678 |
| 15503004 | 238 | 129.00 € | 1 | 680 | 17250000 | 267 | 159.90 € | 1 | 678 | 18205000 | 276 | 206.90 € | 1 | 678 |
| 15503027 | 238 | 129.00 € | 1 | 680 | 17251000 | 267 | 209.90 € | 1 | 678 | 18206070 | 277 | 184.90 € | 1 | 678 |
| 15504003 | 239 | 149.00 € | 1 | 680 | 17252000 | 267 | 269.90 € | 1 | 678 | 18207000 | 273 | 127.90 € | 1 | 678 |
| 15504004 | 239 | 149.00 € | 1 | 680 | 17290000 | 270 | 239.90 € | 1 | 678 | 18220000 | 275 | 74.90 € | 1 | 678 |
| 15504027 | 239 | 149.00 € | 1 | 680 | 17291000 | 270 | 389.90 € | 1 | 678 | 18223000 | 275 | 139.90 € | 1 | 678 |
| 15521003 | 236 | 129.00 € | 1 | 680 | 17502000 | 272 | 119.90 € | 1 | 678 | 18233000 | 275 | 136.90 € | 1 | 678 |
| 15521004 | 236 | 129.00 € | 1 | 680 | 17511000 | 274 | 64.90 € | 1 | 678 | 18252070 | 269 | 249.90 € | 1 | 678 |
| 15521027 | 236 | 129.00 € | 1 | 680 | 17511000 | 274 | 64.90 € | 1 | 678 | 18252080 | 269 | 249.90 € | 1 | 678 |
| 15522003 | 237 | 139.00 € | 1 | 680 | 17511000 | 275 | 64.90 € | 1 | 678 | 18438002 | 200 | 169.90 € | 1 | 676 |
| 15522004 | 237 | 139.00 € | 1 | 680 | 17518000 | 274 | 129.90 € | 1 | 678 | 18507002 | 243 | 339.00 € | 1 | 680 |
| 15522027 | 237 | 139.00 € | 1 | 680 | 17528000 | 274 | 129.90 € | 1 | 678 | 18577002 | 243 | 379.00 € | 1 | 680 |
| 15523003 | 238 | 149.00 € | 1 | 680 | 17658000 | 202 | 109.90 € | 1 | 678 | 19581003 | 248 | 3,850.00 € | 1 | 680 |
| 15523004 | 238 | 149.00 € | 1 | 680 | 17658010 | 202 | 108.90 € | 1 | 678 | 19581004 | 248 | 3,850.00 € | 1 | 680 |
| 15523027 | 238 | 149.00 € | 1 | 680 | 17658020 | 202 | 117.90 € | 1 | 678 | 19581027 | 248 | 3,850.00 € | 1 | 680 |
| 15524003 | 239 | 169.00 € | 1 | 680 | 17662000 | 202 | 31.50 € | 1 | 678 | 19581103 | 248 | 1,439.00 € | 1 | 680 |
| 15524004 | 239 | 169.00 € | 1 | 680 | 17662010 | 202 | 28.00 € | 1 | 678 | 19581104 | 248 | 1,439.00 € | 1 | 680 |
| 15524027 | 239 | 169.00 € | 1 | 680 | 17662020 | 202 | 41.50 € | 1 | 678 | 19581127 | 248 | 1,439.00 € | 1 | 680 |

| Article no. | Page | Price in € | Discount group | Product group | Article no. | Page | Price in € | Discount group | Product group | Article no. | Page | Price in € | Discount group | Product group |
|-------------|------|------------|----------------|---------------|-------------|------|------------|----------------|---------------|-------------|------|------------|----------------|---------------|
| 19581503 | 248 | 725.00 € | 1 | 680 | 27064180 | 137 | 39.90 € | 1 | 688 | 32069074 | 13 | 299.90 € | 2 | 2941 |
| 19581504 | 248 | 725.00 € | 1 | 680 | 27065170 | 136 | 31.00 € | 1 | 688 | 32070073 | 13 | 199.90 € | 2 | 2941 |
| 19581527 | 248 | 725.00 € | 1 | 680 | 27065180 | 136 | 31.00 € | 1 | 688 | 32070074 | 13 | 199.90 € | 2 | 2941 |
| 19582003 | 254 | 3,865.00 € | 1 | 680 | 27066170 | 137 | 27.90 € | 1 | 688 | 32071073 | 13 | 239.90 € | 2 | 2941 |
| 19582004 | 254 | 3,865.00 € | 1 | 680 | 27066180 | 137 | 27.90 € | 1 | 688 | 32071074 | 13 | 239.90 € | 2 | 2941 |
| 19582027 | 254 | 3,865.00 € | 1 | 680 | 27067170 | 137 | 28.90 € | 1 | 688 | 32072073 | 13 | 195.90 € | 2 | 2941 |
| 19582103 | 254 | 1,445.00 € | 1 | 680 | 27067180 | 137 | 28.90 € | 1 | 688 | 32072074 | 13 | 195.90 € | 2 | 2941 |
| 19582104 | 254 | 1,445.00 € | 1 | 680 | 27068170 | 137 | 28.80 € | 1 | 688 | 32073073 | 13 | 229.90 € | 2 | 2941 |
| 19582127 | 254 | 1,445.00 € | 1 | 680 | 27068180 | 137 | 28.80 € | 1 | 688 | 32073074 | 13 | 229.90 € | 2 | 2941 |
| 19582503 | 254 | 728.00 € | 1 | 680 | 32050073 | 12 | 109.90 € | 2 | 2941 | 32074074 | 13 | 329.90 € | 2 | 2941 |
| 19582504 | 254 | 728.00 € | 1 | 680 | 32050074 | 12 | 109.90 € | 2 | 2941 | 35001420 | 366 | 269.90 € | 1 | 693 |
| 19582527 | 254 | 728.00 € | 1 | 680 | 32051073 | 12 | 129.90 € | 2 | 2941 | 36004070 | 304 | 81.90 € | 1 | 693 |
| 19591004 | 250 | 1,050.00 € | 1 | 680 | 32051074 | 12 | 129.90 € | 2 | 2941 | 36004220 | 304 | 81.90 € | 1 | 693 |
| 19592004 | 256 | 1,065.00 € | 1 | 680 | 32052073 | 12 | 99.90 € | 2 | 2941 | 36005070 | 306 | 84.90 € | 1 | 693 |
| 19601002 | 252 | 1,480.00 € | 1 | 680 | 32052074 | 12 | 99.90 € | 2 | 2941 | 36005080 | 306 | 84.90 € | 1 | 693 |
| 19601502 | 252 | 730.00 € | 1 | 680 | 32053073 | 12 | 119.90 € | 2 | 2941 | 36005220 | 306 | 84.90 € | 1 | 693 |
| 19602002 | 258 | 1,495.00 € | 1 | 680 | 32053074 | 12 | 119.90 € | 2 | 2941 | 36143020 | 158 | 38.90 € | 1 | 688 |
| 19602502 | 258 | 760.00 € | 1 | 680 | 32054074 | 12 | 209.90 € | 2 | 2941 | 36143070 | 158 | 37.90 € | 1 | 688 |
| 20043170 | 168 | 24.90 € | 1 | 688 | 32055073 | 12 | 99.90 € | 2 | 2941 | 36143080 | 158 | 37.90 € | 1 | 688 |
| 20043180 | 168 | 24.90 € | 1 | 688 | 32055074 | 12 | 99.90 € | 2 | 2941 | 36143170 | 158 | 37.90 € | 1 | 688 |
| 20044170 | 168 | 24.90 € | 1 | 688 | 32056073 | 12 | 119.90 € | 2 | 2941 | 36143250 | 158 | 37.90 € | 1 | 688 |
| 20044180 | 168 | 24.90 € | 1 | 688 | 32056074 | 12 | 119.90 € | 2 | 2941 | 36143630 | 158 | 42.90 € | 1 | 688 |
| 20045170 | 168 | 28.90 € | 1 | 688 | 32057073 | 12 | 89.90 € | 2 | 2941 | 36143640 | 158 | 42.90 € | 1 | 688 |
| 20045180 | 168 | 28.90 € | 1 | 688 | 32057074 | 12 | 89.90 € | 2 | 2941 | 36143780 | 158 | 42.90 € | 1 | 688 |
| 20046170 | 168 | 28.90 € | 1 | 688 | 32058073 | 12 | 109.90 € | 2 | 2941 | 36144020 | 160 | 41.90 € | 1 | 688 |
| 20046180 | 168 | 28.90 € | 1 | 688 | 32058074 | 12 | 109.90 € | 2 | 2941 | 36144070 | 160 | 39.90 € | 1 | 688 |
| 20173170 | 164 | 44.90 € | 1 | 688 | 32059074 | 12 | 199.90 € | 2 | 2941 | 36144080 | 160 | 39.90 € | 1 | 688 |
| 20173180 | 164 | 44.90 € | 1 | 688 | 32060073 | 13 | 139.90 € | 2 | 2941 | 36144170 | 160 | 39.90 € | 1 | 688 |
| 20173550 | 164 | 44.90 € | 1 | 688 | 32060074 | 13 | 139.90 € | 2 | 2941 | 36144250 | 160 | 39.90 € | 1 | 688 |
| 20173560 | 164 | 44.90 € | 1 | 688 | 32061073 | 13 | 179.90 € | 2 | 2941 | 36144630 | 160 | 45.90 € | 1 | 688 |
| 20173740 | 164 | 44.90 € | 1 | 688 | 32061074 | 13 | 179.90 € | 2 | 2941 | 36144640 | 160 | 45.90 € | 1 | 688 |
| 20173760 | 164 | 44.90 € | 1 | 688 | 32062073 | 13 | 134.90 € | 2 | 2941 | 36144780 | 160 | 45.90 € | 1 | 688 |
| 20173770 | 164 | 44.90 € | 1 | 688 | 32062074 | 13 | 134.90 € | 2 | 2941 | 36147220 | 300 | 105.90 € | 1 | 688 |
| 20173840 | 164 | 44.90 € | 1 | 688 | 32063073 | 13 | 169.90 € | 2 | 2941 | 36148220 | 301 | 112.90 € | 1 | 688 |
| 20173860 | 164 | 44.90 € | 1 | 688 | 32063074 | 13 | 169.90 € | 2 | 2941 | 37005070 | 303 | 84.40 € | 1 | 688 |
| 20173870 | 164 | 44.90 € | 1 | 688 | 32064074 | 13 | 249.90 € | 2 | 2941 | 37005080 | 303 | 84.40 € | 1 | 688 |
| 26004070 | 304 | 71.30 € | 1 | 688 | 32065073 | 13 | 179.90 € | 2 | 2941 | 37005420 | 303 | 87.60 € | 1 | 688 |
| 26004220 | 304 | 71.30 € | 1 | 688 | 32065074 | 13 | 179.90 € | 2 | 2941 | 37006070 | 303 | 90.10 € | 1 | 688 |
| 26005070 | 306 | 74.30 € | 1 | 688 | 32066073 | 13 | 219.90 € | 2 | 2941 | 37006080 | 303 | 90.10 € | 1 | 688 |
| 26005080 | 306 | 74.30 € | 1 | 688 | 32066074 | 13 | 219.90 € | 2 | 2941 | 37006420 | 303 | 94.90 € | 1 | 688 |
| 26005220 | 306 | 74.30 € | 1 | 688 | 32067073 | 13 | 174.90 € | 2 | 2941 | 37015070 | 303 | 87.40 € | 1 | 688 |
| 27063170 | 136 | 28.80 € | 1 | 688 | 32067074 | 13 | 174.90 € | 2 | 2941 | 37015080 | 303 | 87.40 € | 1 | 688 |
| 27063180 | 136 | 28.80 € | 1 | 688 | 32068073 | 13 | 209.90 € | 2 | 2941 | 37015420 | 303 | 89.90 € | 1 | 688 |
| 27064170 | 137 | 39.90 € | 1 | 688 | 32068074 | 13 | 209.90 € | 2 | 2941 | 37016070 | 303 | 92.60 € | 1 | 688 |

| Article no. | Page | Price in € | Discount group | Product group |
|-------------|------|------------|----------------|---------------|
| 37016080 | 303 | 92.60 € | 1 | 688 |
| 37016420 | 303 | 97.30 € | 1 | 688 |
| 38143023 | 159 | 115.90 € | 1 | 679 |
| 38143073 | 159 | 114.90 € | 1 | 679 |
| 38143083 | 159 | 114.90 € | 1 | 679 |
| 38143173 | 159 | 114.90 € | 1 | 679 |
| 38143253 | 159 | 114.90 € | 1 | 679 |
| 38143633 | 159 | 119.90 € | 1 | 679 |
| 38143643 | 159 | 119.90 € | 1 | 679 |
| 38143783 | 159 | 119.90 € | 1 | 679 |
| 38144023 | 161 | 118.90 € | 1 | 679 |
| 38144073 | 161 | 116.90 € | 1 | 679 |
| 38144083 | 161 | 116.90 € | 1 | 679 |
| 38144173 | 161 | 116.90 € | 1 | 679 |
| 38144253 | 161 | 116.90 € | 1 | 679 |
| 38144633 | 161 | 122.90 € | 1 | 679 |
| 38144643 | 161 | 122.90 € | 1 | 679 |
| 38144783 | 161 | 122.90 € | 1 | 679 |
| 38147223 | 300 | 185.90 € | 1 | 679 |
| 38148223 | 301 | 190.90 € | 1 | 679 |
| 38363023 | 146 | 55.00 € | 1 | 679 |
| 38363073 | 146 | 51.20 € | 1 | 679 |
| 38363153 | 146 | 55.00 € | 1 | 679 |
| 38363173 | 146 | 51.20 € | 1 | 679 |
| 38363183 | 146 | 51.20 € | 1 | 679 |
| 38365023 | 148 | 57.50 € | 1 | 679 |
| 38365073 | 148 | 52.50 € | 1 | 679 |
| 38365153 | 148 | 57.50 € | 1 | 679 |
| 38365173 | 148 | 52.50 € | 1 | 679 |
| 38365183 | 148 | 52.50 € | 1 | 679 |
| 38375073 | 304 | 102.90 € | 1 | 679 |
| 38375423 | 304 | 102.90 € | 1 | 679 |
| 38376073 | 306 | 105.90 € | 1 | 679 |
| 38376083 | 306 | 105.90 € | 1 | 679 |
| 38376423 | 306 | 105.90 € | 1 | 679 |
| 38463023 | 146 | 63.40 € | 1 | 679 |
| 38463073 | 146 | 59.60 € | 1 | 679 |
| 38463153 | 146 | 63.40 € | 1 | 679 |
| 38463173 | 146 | 59.60 € | 1 | 679 |
| 38463183 | 146 | 59.60 € | 1 | 679 |
| 38465023 | 148 | 65.90 € | 1 | 679 |
| 38465073 | 148 | 60.90 € | 1 | 679 |
| 38465153 | 148 | 65.90 € | 1 | 679 |
| 38465173 | 148 | 60.90 € | 1 | 679 |

| Article no. | Page | Price in € | Discount group | Product group |
|-------------|------|------------|----------------|---------------|
| 38465183 | 148 | 60.90 € | 1 | 679 |
| 39143023 | 159 | 120.90 € | 1 | 679 |
| 39143073 | 159 | 118.90 € | 1 | 679 |
| 39143083 | 159 | 118.90 € | 1 | 679 |
| 39143173 | 159 | 118.90 € | 1 | 679 |
| 39143253 | 159 | 118.90 € | 1 | 679 |
| 39143633 | 159 | 124.90 € | 1 | 679 |
| 39143643 | 159 | 124.90 € | 1 | 679 |
| 39143783 | 159 | 124.90 € | 1 | 679 |
| 39144023 | 161 | 123.90 € | 1 | 679 |
| 39144073 | 161 | 121.90 € | 1 | 679 |
| 39144083 | 161 | 121.90 € | 1 | 679 |
| 39144173 | 161 | 121.90 € | 1 | 679 |
| 39144253 | 161 | 121.90 € | 1 | 679 |
| 39144633 | 161 | 127.90 € | 1 | 679 |
| 39144643 | 161 | 127.90 € | 1 | 679 |
| 39144783 | 161 | 127.90 € | 1 | 679 |
| 39147223 | 300 | 190.90 € | 1 | 679 |
| 39148223 | 301 | 196.90 € | 1 | 679 |
| 39173173 | 165 | 145.00 € | 1 | 679 |
| 39173173DW | 165 | 159.90 € | 1 | 679 |
| 39173174 | 165 | 145.00 € | 1 | 679 |
| 39173183 | 165 | 145.00 € | 1 | 679 |
| 39173183DW | 165 | 159.90 € | 1 | 679 |
| 39173184 | 165 | 145.00 € | 1 | 679 |
| 39173727 | 165 | 145.00 € | 1 | 679 |
| 39173827 | 165 | 145.00 € | 1 | 679 |
| 39253073 | 153 | 72.70 € | 1 | 679 |
| 39253083 | 153 | 72.70 € | 1 | 679 |
| 39253153 | 153 | 74.20 € | 1 | 679 |
| 39255073 | 153 | 74.20 € | 1 | 679 |
| 39255083 | 153 | 74.20 € | 1 | 679 |
| 39255153 | 153 | 75.70 € | 1 | 679 |
| 39336173 | 170 | 70.40 € | 1 | 691 |
| 39336183 | 170 | 70.40 € | 1 | 691 |
| 39337173 | 170 | 75.00 € | 1 | 691 |
| 39337183 | 170 | 75.00 € | 1 | 691 |
| 39338173 | 171 | 75.00 € | 1 | 691 |
| 39338183 | 171 | 75.00 € | 1 | 691 |
| 39339173 | 171 | 80.50 € | 1 | 691 |
| 39339183 | 171 | 80.50 € | 1 | 691 |
| 39363023 | 146 | 57.50 € | 1 | 679 |
| 39363073 | 146 | 53.70 € | 1 | 679 |
| 39363153 | 146 | 57.50 € | 1 | 679 |

| Article no. | Page | Price in € | Discount group | Product group |
|-------------|------|------------|----------------|---------------|
| 39363173 | 146 | 53.70 € | 1 | 679 |
| 39363183 | 146 | 53.70 € | 1 | 679 |
| 39365023 | 148 | 60.00 € | 1 | 679 |
| 39365073 | 148 | 55.00 € | 1 | 679 |
| 39365153 | 148 | 60.00 € | 1 | 679 |
| 39365173 | 148 | 55.00 € | 1 | 679 |
| 39365183 | 148 | 55.00 € | 1 | 679 |
| 39375073 | 305 | 107.30 € | 1 | 679 |
| 39375083 | 305 | 107.30 € | 1 | 679 |
| 39375423 | 305 | 107.30 € | 1 | 679 |
| 39376073 | 307 | 110.90 € | 1 | 679 |
| 39376083 | 307 | 110.90 € | 1 | 679 |
| 39376423 | 307 | 110.90 € | 1 | 679 |
| 39383173 | 135 | 57.70 € | 1 | 688 |
| 39383183 | 135 | 57.70 € | 1 | 688 |
| 39385173 | 135 | 59.00 € | 1 | 688 |
| 39385183 | 135 | 59.00 € | 1 | 688 |
| 39413153 | 140 | 84.90 € | 1 | 679 |
| 39413153DW | 140 | 94.90 € | 1 | 679 |
| 39413173 | 140 | 79.90 € | 1 | 679 |
| 39413173DW | 140 | 89.90 € | 1 | 679 |
| 39413183 | 140 | 79.90 € | 1 | 679 |
| 39413183DW | 140 | 89.90 € | 1 | 679 |
| 39415153 | 142 | 89.90 € | 1 | 679 |
| 39415153DW | 142 | 99.90 € | 1 | 679 |
| 39415173 | 142 | 84.90 € | 1 | 679 |
| 39415173DW | 142 | 94.90 € | 1 | 679 |
| 39415183 | 142 | 84.90 € | 1 | 679 |
| 39415183DW | 142 | 94.90 € | 1 | 679 |
| 39461073 | 157 | 108.90 € | 1 | 679 |
| 39461083 | 157 | 108.90 € | 1 | 679 |
| 39461253 | 157 | 113.90 € | 1 | 679 |
| 39462073 | 157 | 112.90 € | 1 | 679 |
| 39462083 | 157 | 112.90 € | 1 | 679 |
| 39462253 | 157 | 117.50 € | 1 | 679 |
| 39463023 | 146 | 65.90 € | 1 | 679 |
| 39463073 | 146 | 61.90 € | 1 | 679 |
| 39463153 | 146 | 65.90 € | 1 | 679 |
| 39463173 | 146 | 61.90 € | 1 | 679 |
| 39463183 | 146 | 61.90 € | 1 | 679 |
| 39465023 | 148 | 67.90 € | 1 | 679 |
| 39465073 | 148 | 62.90 € | 1 | 679 |
| 39465153 | 148 | 67.90 € | 1 | 679 |
| 39465173 | 148 | 62.90 € | 1 | 679 |

| Article no. | Page | Price in € | Discount group | Product group | Article no. | Page | Price in € | Discount group | Product group | Article no. | Page | Price in € | Discount group | Product group |
|-------------|------|------------|----------------|---------------|-------------|------|------------|----------------|---------------|-------------|------|------------|----------------|---------------|
| 39465183 | 148 | 62.90 € | 1 | 679 | 40365153 | 149 | 73.70 € | 1 | 679 | 40612173DA | 30 | 239.90 € | 1 | 679 |
| 39475073 | 305 | 108.90 € | 1 | 679 | 40365173 | 149 | 68.70 € | 1 | 679 | 40612174 | 30 | 169.90 € | 1 | 679 |
| 39475083 | 305 | 108.90 € | 1 | 679 | 40365183 | 149 | 68.70 € | 1 | 679 | 40612174DA | 30 | 239.90 € | 1 | 679 |
| 39475423 | 305 | 108.90 € | 1 | 679 | 40375073 | 305 | 113.90 € | 1 | 679 | 40612175 | 30 | 169.90 € | 1 | 679 |
| 39476073 | 307 | 112.90 € | 1 | 679 | 40375083 | 305 | 113.90 € | 1 | 679 | 40612175DA | 30 | 239.90 € | 1 | 679 |
| 39476083 | 307 | 112.90 € | 1 | 679 | 40375423 | 305 | 113.90 € | 1 | 679 | 40612183 | 30 | 169.90 € | 1 | 679 |
| 39476423 | 307 | 112.90 € | 1 | 679 | 40376073 | 307 | 117.90 € | 1 | 679 | 40612183DA | 30 | 239.90 € | 1 | 679 |
| 39483023 | 151 | 95.50 € | 1 | 679 | 40376083 | 307 | 117.90 € | 1 | 679 | 40612184 | 30 | 169.90 € | 1 | 679 |
| 39483073 | 151 | 94.20 € | 1 | 679 | 40376423 | 307 | 117.90 € | 1 | 679 | 40612184DA | 30 | 239.90 € | 1 | 679 |
| 39483083 | 151 | 94.20 € | 1 | 679 | 40463023 | 147 | 79.70 € | 1 | 679 | 40612185 | 30 | 169.90 € | 1 | 679 |
| 39483173 | 151 | 94.20 € | 1 | 679 | 40463073 | 147 | 75.90 € | 1 | 679 | 40612185DA | 30 | 239.90 € | 1 | 679 |
| 39483253 | 151 | 94.20 € | 1 | 679 | 40463153 | 147 | 79.70 € | 1 | 679 | 40613163 | 32 | 199.90 € | 1 | 679 |
| 39483633 | 151 | 99.90 € | 1 | 679 | 40463173 | 147 | 75.90 € | 1 | 679 | 40613163DA | 32 | 289.90 € | 1 | 679 |
| 39483643 | 151 | 99.90 € | 1 | 679 | 40463183 | 147 | 75.90 € | 1 | 679 | 40613164 | 32 | 199.90 € | 1 | 679 |
| 39485023 | 151 | 98.60 € | 1 | 679 | 40465023 | 149 | 82.10 € | 1 | 679 | 40613164DA | 32 | 289.90 € | 1 | 679 |
| 39485073 | 151 | 97.30 € | 1 | 679 | 40465073 | 149 | 77.10 € | 1 | 679 | 40613165 | 32 | 199.90 € | 1 | 679 |
| 39485083 | 151 | 97.30 € | 1 | 679 | 40465153 | 149 | 82.10 € | 1 | 679 | 40613165DA | 32 | 289.90 € | 1 | 679 |
| 39485173 | 151 | 97.30 € | 1 | 679 | 40465173 | 149 | 77.10 € | 1 | 679 | 40613173 | 32 | 199.90 € | 1 | 679 |
| 39485253 | 151 | 97.30 € | 1 | 679 | 40465183 | 149 | 77.10 € | 1 | 679 | 40613173DA | 32 | 289.90 € | 1 | 679 |
| 39485633 | 151 | 103.00 € | 1 | 679 | 40611163 | 28 | 139.90 € | 1 | 679 | 40613174 | 32 | 199.90 € | 1 | 679 |
| 39485643 | 151 | 103.00 € | 1 | 679 | 40611163DA | 28 | 199.90 € | 1 | 679 | 40613174DA | 32 | 289.90 € | 1 | 679 |
| 40143023 | 159 | 130.90 € | 1 | 679 | 40611164 | 28 | 139.90 € | 1 | 679 | 40613175 | 32 | 199.90 € | 1 | 679 |
| 40143073 | 159 | 128.90 € | 1 | 679 | 40611164DA | 28 | 199.90 € | 1 | 679 | 40613175DA | 32 | 289.90 € | 1 | 679 |
| 40143083 | 159 | 128.90 € | 1 | 679 | 40611165 | 28 | 139.90 € | 1 | 679 | 40613183 | 32 | 199.90 € | 1 | 679 |
| 40143173 | 159 | 128.90 € | 1 | 679 | 40611165DA | 28 | 199.90 € | 1 | 679 | 40613183DA | 32 | 289.90 € | 1 | 679 |
| 40143253 | 159 | 128.90 € | 1 | 679 | 40611173 | 28 | 139.90 € | 1 | 679 | 40613184 | 32 | 199.90 € | 1 | 679 |
| 40143633 | 159 | 134.90 € | 1 | 679 | 40611173DA | 28 | 199.90 € | 1 | 679 | 40613184DA | 32 | 289.90 € | 1 | 679 |
| 40143643 | 159 | 134.90 € | 1 | 679 | 40611174 | 28 | 139.90 € | 1 | 679 | 40613185 | 32 | 199.90 € | 1 | 679 |
| 40143783 | 159 | 134.90 € | 1 | 679 | 40611174DA | 28 | 199.90 € | 1 | 679 | 40613185DA | 32 | 289.90 € | 1 | 679 |
| 40144023 | 161 | 133.90 € | 1 | 679 | 40611175 | 28 | 139.90 € | 1 | 679 | 40614163 | 34 | 239.90 € | 1 | 679 |
| 40144073 | 161 | 131.90 € | 1 | 679 | 40611175DA | 28 | 199.90 € | 1 | 679 | 40614163DA | 34 | 339.90 € | 1 | 679 |
| 40144083 | 161 | 131.90 € | 1 | 679 | 40611183 | 28 | 139.90 € | 1 | 679 | 40614164 | 34 | 239.90 € | 1 | 679 |
| 40144173 | 161 | 131.90 € | 1 | 679 | 40611183DA | 28 | 199.90 € | 1 | 679 | 40614164DA | 34 | 339.90 € | 1 | 679 |
| 40144253 | 161 | 131.90 € | 1 | 679 | 40611184 | 28 | 139.90 € | 1 | 679 | 40614165 | 34 | 239.90 € | 1 | 679 |
| 40144633 | 161 | 137.90 € | 1 | 679 | 40611184DA | 28 | 199.90 € | 1 | 679 | 40614165DA | 34 | 339.90 € | 1 | 679 |
| 40144643 | 161 | 137.90 € | 1 | 679 | 40611185 | 28 | 139.90 € | 1 | 679 | 40614173 | 34 | 239.90 € | 1 | 679 |
| 40144783 | 161 | 137.90 € | 1 | 679 | 40611185DA | 28 | 199.90 € | 1 | 679 | 40614173DA | 34 | 339.90 € | 1 | 679 |
| 40363023 | 147 | 71.30 € | 1 | 679 | 40612163 | 30 | 169.90 € | 1 | 679 | 40614174 | 34 | 239.90 € | 1 | 679 |
| 40363073 | 147 | 67.50 € | 1 | 679 | 40612163DA | 30 | 239.90 € | 1 | 679 | 40614174DA | 34 | 339.90 € | 1 | 679 |
| 40363153 | 147 | 71.30 € | 1 | 679 | 40612164 | 30 | 169.90 € | 1 | 679 | 40614175 | 34 | 239.90 € | 1 | 679 |
| 40363173 | 147 | 67.50 € | 1 | 679 | 40612164DA | 30 | 239.90 € | 1 | 679 | 40614175DA | 34 | 339.90 € | 1 | 679 |
| 40363183 | 147 | 67.50 € | 1 | 679 | 40612165 | 30 | 169.90 € | 1 | 679 | 40614183 | 34 | 239.90 € | 1 | 679 |
| 40365023 | 149 | 73.70 € | 1 | 679 | 40612165DA | 30 | 239.90 € | 1 | 679 | 40614183DA | 34 | 339.90 € | 1 | 679 |
| 40365073 | 149 | 68.70 € | 1 | 679 | 40612173 | 30 | 169.90 € | 1 | 679 | 40614184 | 34 | 239.90 € | 1 | 679 |

| Article no. | Page | Price in € | Discount group | Product group | Article no. | Page | Price in € | Discount group | Product group | Article no. | Page | Price in € | Discount group | Product group |
|-------------|------|------------|----------------|---------------|-------------|------|------------|----------------|---------------|-------------|------|------------|----------------|---------------|
| 40614184DA | 34 | 339.90 € | 1 | 679 | 40642165DA | 30 | 239.90 € | 1 | 679 | 40644183DA | 34 | 339.90 € | 1 | 679 |
| 40614185 | 34 | 239.90 € | 1 | 679 | 40642173 | 30 | 169.90 € | 1 | 679 | 40644184 | 34 | 239.90 € | 1 | 679 |
| 40614185DA | 34 | 339.90 € | 1 | 679 | 40642173DA | 30 | 239.90 € | 1 | 679 | 40644184DA | 34 | 339.90 € | 1 | 679 |
| 40615163 | 36 | 299.90 € | 1 | 679 | 40642174 | 30 | 169.90 € | 1 | 679 | 40644185 | 34 | 239.90 € | 1 | 679 |
| 40615163DA | 36 | 399.90 € | 1 | 679 | 40642174DA | 30 | 239.90 € | 1 | 679 | 40644185DA | 34 | 339.90 € | 1 | 679 |
| 40615164 | 36 | 299.90 € | 1 | 679 | 40642175 | 30 | 169.90 € | 1 | 679 | 40645163 | 36 | 299.90 € | 1 | 679 |
| 40615164DA | 36 | 399.90 € | 1 | 679 | 40642175DA | 30 | 239.90 € | 1 | 679 | 40645163DA | 36 | 455.00 € | 1 | 679 |
| 40615165 | 36 | 299.90 € | 1 | 679 | 40642183 | 30 | 169.90 € | 1 | 679 | 40645164 | 36 | 299.90 € | 1 | 679 |
| 40615165DA | 36 | 399.90 € | 1 | 679 | 40642183DA | 30 | 239.90 € | 1 | 679 | 40645164DA | 36 | 455.00 € | 1 | 679 |
| 40615173 | 36 | 299.90 € | 1 | 679 | 40642184 | 30 | 169.90 € | 1 | 679 | 40645165 | 36 | 299.90 € | 1 | 679 |
| 40615173DA | 36 | 399.90 € | 1 | 679 | 40642184DA | 30 | 239.90 € | 1 | 679 | 40645165DA | 36 | 455.00 € | 1 | 679 |
| 40615174 | 36 | 299.90 € | 1 | 679 | 40642185 | 30 | 169.90 € | 1 | 679 | 40645173 | 36 | 299.90 € | 1 | 679 |
| 40615174DA | 36 | 399.90 € | 1 | 679 | 40642185DA | 30 | 239.90 € | 1 | 679 | 40645173DA | 36 | 455.00 € | 1 | 679 |
| 40615175 | 36 | 299.90 € | 1 | 679 | 40643163 | 32 | 199.90 € | 1 | 679 | 40645174 | 36 | 299.90 € | 1 | 679 |
| 40615175DA | 36 | 399.90 € | 1 | 679 | 40643163DA | 32 | 289.90 € | 1 | 679 | 40645174DA | 36 | 455.00 € | 1 | 679 |
| 40615183 | 36 | 299.90 € | 1 | 679 | 40643164 | 32 | 199.90 € | 1 | 679 | 40645175 | 36 | 299.90 € | 1 | 679 |
| 40615183DA | 36 | 399.90 € | 1 | 679 | 40643164DA | 32 | 289.90 € | 1 | 679 | 40645175DA | 36 | 455.00 € | 1 | 679 |
| 40615184 | 36 | 299.90 € | 1 | 679 | 40643165 | 32 | 199.90 € | 1 | 679 | 40645183 | 36 | 299.90 € | 1 | 679 |
| 40615184DA | 36 | 399.90 € | 1 | 679 | 40643165DA | 32 | 289.90 € | 1 | 679 | 40645183DA | 36 | 455.00 € | 1 | 679 |
| 40615185 | 36 | 299.90 € | 1 | 679 | 40643173 | 32 | 199.90 € | 1 | 679 | 40645184 | 36 | 299.90 € | 1 | 679 |
| 40615185DA | 36 | 399.90 € | 1 | 679 | 40643173DA | 32 | 289.90 € | 1 | 679 | 40645184DA | 36 | 455.00 € | 1 | 679 |
| 40641163 | 28 | 139.90 € | 1 | 679 | 40643174 | 32 | 199.90 € | 1 | 679 | 40645185 | 36 | 299.90 € | 1 | 679 |
| 40641163DA | 28 | 199.90 € | 1 | 679 | 40643174DA | 32 | 289.90 € | 1 | 679 | 40645185DA | 36 | 455.00 € | 1 | 679 |
| 40641164 | 28 | 139.90 € | 1 | 679 | 40643175 | 32 | 199.90 € | 1 | 679 | 40670163 | 39 | 109.90 € | 1 | 679 |
| 40641164DA | 28 | 199.90 € | 1 | 679 | 40643175DA | 32 | 289.90 € | 1 | 679 | 40670163DA | 39 | 164.90 € | 1 | 679 |
| 40641165 | 28 | 139.90 € | 1 | 679 | 40643183 | 32 | 199.90 € | 1 | 679 | 40670164 | 39 | 109.90 € | 1 | 679 |
| 40641165DA | 28 | 199.90 € | 1 | 679 | 40643183DA | 32 | 289.90 € | 1 | 679 | 40670164DA | 39 | 164.90 € | 1 | 679 |
| 40641173 | 28 | 139.90 € | 1 | 679 | 40643184 | 32 | 199.90 € | 1 | 679 | 40670173 | 39 | 109.90 € | 1 | 679 |
| 40641173DA | 28 | 199.90 € | 1 | 679 | 40643184DA | 32 | 289.90 € | 1 | 679 | 40670173DA | 39 | 164.90 € | 1 | 679 |
| 40641174 | 28 | 139.90 € | 1 | 679 | 40643185 | 32 | 199.90 € | 1 | 679 | 40670174 | 39 | 109.90 € | 1 | 679 |
| 40641174DA | 28 | 199.90 € | 1 | 679 | 40643185DA | 32 | 289.90 € | 1 | 679 | 40670174DA | 39 | 164.90 € | 1 | 679 |
| 40641175 | 28 | 139.90 € | 1 | 679 | 40644163 | 34 | 239.90 € | 1 | 679 | 40670183 | 39 | 109.90 € | 1 | 679 |
| 40641175DA | 28 | 199.90 € | 1 | 679 | 40644163DA | 34 | 339.90 € | 1 | 679 | 40670183DA | 39 | 164.90 € | 1 | 679 |
| 40641183 | 28 | 139.90 € | 1 | 679 | 40644164 | 34 | 239.90 € | 1 | 679 | 40670184 | 39 | 109.90 € | 1 | 679 |
| 40641183DA | 28 | 199.90 € | 1 | 679 | 40644164DA | 34 | 339.90 € | 1 | 679 | 40670184DA | 39 | 164.90 € | 1 | 679 |
| 40641184 | 28 | 139.90 € | 1 | 679 | 40644165 | 34 | 239.90 € | 1 | 679 | 40671163 | 40 | 129.90 € | 1 | 679 |
| 40641184DA | 28 | 199.90 € | 1 | 679 | 40644165DA | 34 | 339.90 € | 1 | 679 | 40671163DA | 40 | 184.90 € | 1 | 679 |
| 40641185 | 28 | 139.90 € | 1 | 679 | 40644173 | 34 | 239.90 € | 1 | 679 | 40671164 | 40 | 129.90 € | 1 | 679 |
| 40641185DA | 28 | 199.90 € | 1 | 679 | 40644173DA | 34 | 339.90 € | 1 | 679 | 40671164DA | 40 | 184.90 € | 1 | 679 |
| 40642163 | 30 | 169.90 € | 1 | 679 | 40644174 | 34 | 239.90 € | 1 | 679 | 40671173 | 40 | 129.90 € | 1 | 679 |
| 40642163DA | 30 | 239.90 € | 1 | 679 | 40644174DA | 34 | 339.90 € | 1 | 679 | 40671173DA | 40 | 184.90 € | 1 | 679 |
| 40642164 | 30 | 169.90 € | 1 | 679 | 40644175 | 34 | 239.90 € | 1 | 679 | 40671174 | 40 | 129.90 € | 1 | 679 |
| 40642164DA | 30 | 239.90 € | 1 | 679 | 40644175DA | 34 | 339.90 € | 1 | 679 | 40671174DA | 40 | 184.90 € | 1 | 679 |
| 40642165 | 30 | 169.90 € | 1 | 679 | 40644183 | 34 | 239.90 € | 1 | 679 | 40671183 | 40 | 129.90 € | 1 | 679 |

| Article no. | Page | Price in € | Discount group | Product group | Article no. | Page | Price in € | Discount group | Product group | Article no. | Page | Price in € | Discount group | Product group |
|-------------|------|------------|----------------|---------------|-------------|------|------------|----------------|---------------|-------------|------|------------|----------------|---------------|
| 40671183DA | 40 | 184.90 € | 1 | 679 | 41413174TW | 141 | 149.90 € | 1 | 679 | 41473184 | 165 | 199.90 € | 1 | 679 |
| 40671184 | 40 | 129.90 € | 1 | 679 | 41413183 | 141 | 119.00 € | 1 | 679 | 41473727 | 165 | 199.90 € | 1 | 679 |
| 40671184DA | 40 | 184.90 € | 1 | 679 | 41413183DW | 141 | 129.00 € | 1 | 679 | 41473827 | 165 | 199.90 € | 1 | 679 |
| 40672163 | 40 | 159.90 € | 1 | 679 | 41413184TW | 141 | 149.90 € | 1 | 679 | 41475073 | 305 | 151.90 € | 1 | 679 |
| 40672163DA | 40 | 214.90 € | 1 | 679 | 41415153 | 143 | 129.90 € | 1 | 679 | 41475083 | 305 | 151.90 € | 1 | 679 |
| 40672164 | 40 | 159.90 € | 1 | 679 | 41415153DW | 143 | 139.90 € | 1 | 679 | 41475423 | 305 | 151.90 € | 1 | 679 |
| 40672164DA | 40 | 214.90 € | 1 | 679 | 41415154TW | 143 | 159.90 € | 1 | 679 | 41476073 | 307 | 154.90 € | 1 | 679 |
| 40672173 | 40 | 159.90 € | 1 | 679 | 41415173 | 143 | 124.90 € | 1 | 679 | 41476083 | 307 | 154.90 € | 1 | 679 |
| 40672173DA | 40 | 214.90 € | 1 | 679 | 41415173DW | 143 | 134.90 € | 1 | 679 | 41476423 | 307 | 154.90 € | 1 | 679 |
| 40672174 | 40 | 159.90 € | 1 | 679 | 41415174TW | 143 | 154.90 € | 1 | 679 | 41611163 | 29 | 139.90 € | 1 | 679 |
| 40672174DA | 40 | 214.90 € | 1 | 679 | 41415183 | 143 | 124.90 € | 1 | 679 | 41611163DA | 29 | 199.90 € | 1 | 679 |
| 40672183 | 40 | 159.90 € | 1 | 679 | 41415183DW | 143 | 134.90 € | 1 | 679 | 41611164 | 29 | 139.90 € | 1 | 679 |
| 40672183DA | 40 | 214.90 € | 1 | 679 | 41415184TW | 143 | 154.90 € | 1 | 679 | 41611164DA | 29 | 199.90 € | 1 | 679 |
| 40672184 | 40 | 159.90 € | 1 | 679 | 41443023 | 159 | 167.90 € | 1 | 679 | 41611165 | 29 | 139.90 € | 1 | 679 |
| 40672184DA | 40 | 214.90 € | 1 | 679 | 41443073 | 159 | 166.90 € | 1 | 679 | 41611165DA | 29 | 199.90 € | 1 | 679 |
| 40673163 | 41 | 189.90 € | 1 | 679 | 41443083 | 159 | 166.90 € | 1 | 679 | 41611173 | 29 | 139.90 € | 1 | 679 |
| 40673163DA | 41 | 249.90 € | 1 | 679 | 41443173 | 159 | 166.90 € | 1 | 679 | 41611173DA | 29 | 199.90 € | 1 | 679 |
| 40673164 | 41 | 189.90 € | 1 | 679 | 41443253 | 159 | 166.90 € | 1 | 679 | 41611174 | 29 | 139.90 € | 1 | 679 |
| 40673164DA | 41 | 249.90 € | 1 | 679 | 41443633 | 159 | 171.90 € | 1 | 679 | 41611174DA | 29 | 199.90 € | 1 | 679 |
| 40673173 | 41 | 189.90 € | 1 | 679 | 41443643 | 159 | 171.90 € | 1 | 679 | 41611175 | 29 | 139.90 € | 1 | 679 |
| 40673173DA | 41 | 249.90 € | 1 | 679 | 41443783 | 159 | 171.90 € | 1 | 679 | 41611175DA | 29 | 199.90 € | 1 | 679 |
| 40673174 | 41 | 189.90 € | 1 | 679 | 41444023 | 161 | 170.90 € | 1 | 679 | 41611183 | 29 | 139.90 € | 1 | 679 |
| 40673174DA | 41 | 249.90 € | 1 | 679 | 41444073 | 161 | 169.90 € | 1 | 679 | 41611183DA | 29 | 199.90 € | 1 | 679 |
| 40673183 | 41 | 189.90 € | 1 | 679 | 41444083 | 161 | 169.90 € | 1 | 679 | 41611184 | 29 | 139.90 € | 1 | 679 |
| 40673183DA | 41 | 249.90 € | 1 | 679 | 41444173 | 161 | 169.90 € | 1 | 679 | 41611184DA | 29 | 199.90 € | 1 | 679 |
| 40673184 | 41 | 189.90 € | 1 | 679 | 41444253 | 161 | 169.90 € | 1 | 679 | 41611185 | 29 | 139.90 € | 1 | 679 |
| 40673184DA | 41 | 249.90 € | 1 | 679 | 41444633 | 161 | 174.90 € | 1 | 679 | 41611185DA | 29 | 199.90 € | 1 | 679 |
| 40674163 | 41 | 219.90 € | 1 | 679 | 41444643 | 161 | 174.90 € | 1 | 679 | 41612163 | 31 | 169.90 € | 1 | 679 |
| 40674163DA | 41 | 279.90 € | 1 | 679 | 41444783 | 161 | 174.90 € | 1 | 679 | 41612163DA | 31 | 239.90 € | 1 | 679 |
| 40674164 | 41 | 219.90 € | 1 | 679 | 41463023 | 147 | 105.90 € | 1 | 679 | 41612164 | 31 | 169.90 € | 1 | 679 |
| 40674164DA | 41 | 279.90 € | 1 | 679 | 41463073 | 147 | 102.90 € | 1 | 679 | 41612164DA | 31 | 239.90 € | 1 | 679 |
| 40674173 | 41 | 219.90 € | 1 | 679 | 41463153 | 147 | 105.90 € | 1 | 679 | 41612165 | 31 | 169.90 € | 1 | 679 |
| 40674173DA | 41 | 279.90 € | 1 | 679 | 41463173 | 147 | 102.90 € | 1 | 679 | 41612165DA | 31 | 239.90 € | 1 | 679 |
| 40674174 | 41 | 219.90 € | 1 | 679 | 41463183 | 147 | 102.90 € | 1 | 679 | 41612173 | 31 | 169.90 € | 1 | 679 |
| 40674174DA | 41 | 279.90 € | 1 | 679 | 41465023 | 149 | 108.90 € | 1 | 679 | 41612173DA | 31 | 239.90 € | 1 | 679 |
| 40674183 | 41 | 219.90 € | 1 | 679 | 41465073 | 149 | 103.90 € | 1 | 679 | 41612174 | 31 | 169.90 € | 1 | 679 |
| 40674183DA | 41 | 279.90 € | 1 | 679 | 41465153 | 149 | 108.90 € | 1 | 679 | 41612174DA | 31 | 239.90 € | 1 | 679 |
| 40674184 | 41 | 219.90 € | 1 | 679 | 41465173 | 149 | 103.90 € | 1 | 679 | 41612175 | 31 | 169.90 € | 1 | 679 |
| 40674184DA | 41 | 249.90 € | 1 | 679 | 41465183 | 149 | 103.90 € | 1 | 679 | 41612175DA | 31 | 239.90 € | 1 | 679 |
| 41413153 | 141 | 124.00 € | 1 | 679 | 41473173 | 165 | 199.90 € | 1 | 679 | 41612183 | 31 | 169.90 € | 1 | 679 |
| 41413153DW | 141 | 134.00 € | 1 | 679 | 41473173DW | 165 | 199.90 € | 1 | 679 | 41612183DA | 31 | 239.90 € | 1 | 679 |
| 41413154TW | 141 | 154.90 € | 1 | 679 | 41473174 | 165 | 199.90 € | 1 | 679 | 41612184 | 31 | 169.90 € | 1 | 679 |
| 41413173 | 141 | 119.00 € | 1 | 679 | 41473183 | 165 | 199.90 € | 1 | 679 | 41612184DA | 31 | 239.90 € | 1 | 679 |
| 41413173DW | 141 | 129.00 € | 1 | 679 | 41473183DW | 165 | 199.90 € | 1 | 679 | 41612185 | 31 | 169.90 € | 1 | 679 |

| Article no. | Page | Price in € | Discount group | Product group | Article no. | Page | Price in € | Discount group | Product group | Article no. | Page | Price in € | Discount group | Product group |
|-------------|------|------------|----------------|---------------|-------------|------|------------|----------------|---------------|-------------|------|------------|----------------|---------------|
| 41612185DA | 31 | 239.90 € | 1 | 679 | 41615173DA | 37 | 339.90 € | 1 | 679 | 41642184DA | 31 | 239.90 € | 1 | 679 |
| 41613163 | 33 | 199.90 € | 1 | 679 | 41615174 | 37 | 299.90 € | 1 | 679 | 41642185 | 31 | 169.90 € | 1 | 679 |
| 41613163DA | 33 | 289.90 € | 1 | 679 | 41615174DA | 37 | 339.90 € | 1 | 679 | 41642185DA | 31 | 239.90 € | 1 | 679 |
| 41613164 | 33 | 199.90 € | 1 | 679 | 41615175 | 37 | 299.90 € | 1 | 679 | 41643163 | 33 | 199.90 € | 1 | 679 |
| 41613164DA | 33 | 289.90 € | 1 | 679 | 41615175DA | 37 | 339.90 € | 1 | 679 | 41643163DA | 33 | 289.90 € | 1 | 679 |
| 41613165 | 33 | 199.90 € | 1 | 679 | 41615183 | 37 | 299.90 € | 1 | 679 | 41643164 | 33 | 199.90 € | 1 | 679 |
| 41613165DA | 33 | 289.90 € | 1 | 679 | 41615183DA | 37 | 339.90 € | 1 | 679 | 41643164DA | 33 | 289.90 € | 1 | 679 |
| 41613173 | 33 | 199.90 € | 1 | 679 | 41615184 | 37 | 299.90 € | 1 | 679 | 41643165 | 33 | 199.90 € | 1 | 679 |
| 41613173DA | 33 | 289.90 € | 1 | 679 | 41615184DA | 37 | 339.90 € | 1 | 679 | 41643165DA | 33 | 289.90 € | 1 | 679 |
| 41613174 | 33 | 199.90 € | 1 | 679 | 41615185 | 37 | 299.90 € | 1 | 679 | 41643173 | 33 | 199.90 € | 1 | 679 |
| 41613174DA | 33 | 289.90 € | 1 | 679 | 41615185DA | 37 | 339.90 € | 1 | 679 | 41643173DA | 33 | 289.90 € | 1 | 679 |
| 41613175 | 33 | 199.90 € | 1 | 679 | 41641163 | 29 | 139.90 € | 1 | 679 | 41643174 | 33 | 199.90 € | 1 | 679 |
| 41613175DA | 33 | 289.90 € | 1 | 679 | 41641163DA | 29 | 199.90 € | 1 | 679 | 41643174DA | 33 | 289.90 € | 1 | 679 |
| 41613183 | 33 | 199.90 € | 1 | 679 | 41641164 | 29 | 139.90 € | 1 | 679 | 41643175 | 33 | 199.90 € | 1 | 679 |
| 41613183DA | 33 | 289.90 € | 1 | 679 | 41641164DA | 29 | 199.90 € | 1 | 679 | 41643175DA | 33 | 289.90 € | 1 | 679 |
| 41613184 | 33 | 199.90 € | 1 | 679 | 41641165 | 29 | 139.90 € | 1 | 679 | 41643183 | 33 | 199.90 € | 1 | 679 |
| 41613184DA | 33 | 289.90 € | 1 | 679 | 41641165DA | 29 | 199.90 € | 1 | 679 | 41643183DA | 33 | 289.90 € | 1 | 679 |
| 41613185 | 33 | 199.90 € | 1 | 679 | 41641173 | 29 | 139.90 € | 1 | 679 | 41643184 | 33 | 199.90 € | 1 | 679 |
| 41613185DA | 33 | 289.90 € | 1 | 679 | 41641173DA | 29 | 199.90 € | 1 | 679 | 41643184DA | 33 | 289.90 € | 1 | 679 |
| 41614163 | 35 | 239.90 € | 1 | 679 | 41641174 | 29 | 139.90 € | 1 | 679 | 41643185 | 33 | 199.90 € | 1 | 679 |
| 41614163DA | 35 | 339.90 € | 1 | 679 | 41641174DA | 29 | 199.90 € | 1 | 679 | 41643185DA | 33 | 289.90 € | 1 | 679 |
| 41614164 | 35 | 239.90 € | 1 | 679 | 41641175 | 29 | 139.90 € | 1 | 679 | 41644163 | 35 | 239.90 € | 1 | 679 |
| 41614164DA | 35 | 339.90 € | 1 | 679 | 41641175DA | 29 | 199.90 € | 1 | 679 | 41644163DA | 35 | 339.90 € | 1 | 679 |
| 41614165 | 35 | 239.90 € | 1 | 679 | 41641183 | 29 | 139.90 € | 1 | 679 | 41644164 | 35 | 239.90 € | 1 | 679 |
| 41614165DA | 35 | 339.90 € | 1 | 679 | 41641183DA | 29 | 199.90 € | 1 | 679 | 41644164DA | 35 | 339.90 € | 1 | 679 |
| 41614173 | 35 | 239.90 € | 1 | 679 | 41641184 | 29 | 139.90 € | 1 | 679 | 41644165 | 35 | 239.90 € | 1 | 679 |
| 41614173DA | 35 | 339.90 € | 1 | 679 | 41641184DA | 29 | 199.90 € | 1 | 679 | 41644165DA | 35 | 339.90 € | 1 | 679 |
| 41614174 | 35 | 239.90 € | 1 | 679 | 41641185 | 29 | 139.90 € | 1 | 679 | 41644173 | 35 | 239.90 € | 1 | 679 |
| 41614174DA | 35 | 339.90 € | 1 | 679 | 41641185DA | 29 | 199.90 € | 1 | 679 | 41644173DA | 35 | 339.90 € | 1 | 679 |
| 41614175 | 35 | 239.90 € | 1 | 679 | 41642163 | 31 | 169.90 € | 1 | 679 | 41644174 | 35 | 239.90 € | 1 | 679 |
| 41614175DA | 35 | 339.90 € | 1 | 679 | 41642163DA | 31 | 239.90 € | 1 | 679 | 41644174DA | 35 | 339.90 € | 1 | 679 |
| 41614183 | 35 | 239.90 € | 1 | 679 | 41642164 | 31 | 169.90 € | 1 | 679 | 41644175 | 35 | 239.90 € | 1 | 679 |
| 41614183DA | 35 | 339.90 € | 1 | 679 | 41642164DA | 31 | 239.90 € | 1 | 679 | 41644175DA | 35 | 339.90 € | 1 | 679 |
| 41614184 | 35 | 239.90 € | 1 | 679 | 41642165 | 31 | 169.90 € | 1 | 679 | 41644183 | 35 | 239.90 € | 1 | 679 |
| 41614184DA | 35 | 339.90 € | 1 | 679 | 41642165DA | 31 | 239.90 € | 1 | 679 | 41644183DA | 35 | 339.90 € | 1 | 679 |
| 41614185 | 35 | 239.90 € | 1 | 679 | 41642173 | 31 | 169.90 € | 1 | 679 | 41644184 | 35 | 239.90 € | 1 | 679 |
| 41614185DA | 35 | 339.90 € | 1 | 679 | 41642173DA | 31 | 239.90 € | 1 | 679 | 41644184DA | 35 | 339.90 € | 1 | 679 |
| 41615163 | 37 | 299.90 € | 1 | 679 | 41642174 | 31 | 169.90 € | 1 | 679 | 41644185 | 35 | 239.90 € | 1 | 679 |
| 41615163DA | 37 | 339.90 € | 1 | 679 | 41642174DA | 31 | 239.90 € | 1 | 679 | 41644185DA | 35 | 339.90 € | 1 | 679 |
| 41615164 | 37 | 299.90 € | 1 | 679 | 41642175 | 31 | 169.90 € | 1 | 679 | 41645163 | 37 | 299.90 € | 1 | 679 |
| 41615164DA | 37 | 339.90 € | 1 | 679 | 41642175DA | 31 | 239.90 € | 1 | 679 | 41645163DA | 37 | 339.90 € | 1 | 679 |
| 41615165 | 37 | 299.90 € | 1 | 679 | 41642183 | 31 | 169.90 € | 1 | 679 | 41645164 | 37 | 299.90 € | 1 | 679 |
| 41615165DA | 37 | 339.90 € | 1 | 679 | 41642183DA | 31 | 239.90 € | 1 | 679 | 41645164DA | 37 | 339.90 € | 1 | 679 |
| 41615173 | 37 | 299.90 € | 1 | 679 | 41642184 | 31 | 169.90 € | 1 | 679 | 41645165 | 37 | 299.90 € | 1 | 679 |

| Article no. | Page | Price in € | Discount group | Product group | Article no. | Page | Price in € | Discount group | Product group | Article no. | Page | Price in € | Discount group | Product group |
|-------------|------|------------|----------------|---------------|-------------|------|------------|----------------|---------------|-------------|------|------------|----------------|---------------|
| 41645165DA | 37 | 339.90 € | 1 | 679 | 42612183DA | 20 | 259.90 € | 1 | 695 | 42641164DA | 18 | 219.90 € | 1 | 695 |
| 41645173 | 37 | 299.90 € | 1 | 679 | 42612184 | 20 | 199.90 € | 1 | 695 | 42641165 | 18 | 169.90 € | 1 | 695 |
| 41645173DA | 37 | 339.90 € | 1 | 679 | 42612184DA | 20 | 259.90 € | 1 | 695 | 42641165DA | 18 | 219.90 € | 1 | 695 |
| 41645174 | 37 | 299.90 € | 1 | 679 | 42612185 | 20 | 199.90 € | 1 | 695 | 42641173 | 18 | 169.90 € | 1 | 695 |
| 41645174DA | 37 | 339.90 € | 1 | 679 | 42612185DA | 20 | 259.90 € | 1 | 695 | 42641173DA | 18 | 219.90 € | 1 | 695 |
| 41645175 | 37 | 299.90 € | 1 | 679 | 42613163 | 22 | 239.90 € | 1 | 695 | 42641174 | 18 | 169.90 € | 1 | 695 |
| 41645175DA | 37 | 339.90 € | 1 | 679 | 42613163DA | 22 | 299.90 € | 1 | 695 | 42641174DA | 18 | 219.90 € | 1 | 695 |
| 41645183 | 37 | 299.90 € | 1 | 679 | 42613164 | 22 | 239.90 € | 1 | 695 | 42641175 | 18 | 169.90 € | 1 | 695 |
| 41645183DA | 37 | 339.90 € | 1 | 679 | 42613164DA | 22 | 299.90 € | 1 | 695 | 42641175DA | 18 | 219.90 € | 1 | 695 |
| 41645184 | 37 | 299.90 € | 1 | 679 | 42613165 | 22 | 239.90 € | 1 | 695 | 42641183 | 18 | 169.90 € | 1 | 695 |
| 41645184DA | 37 | 339.90 € | 1 | 679 | 42613165DA | 22 | 299.90 € | 1 | 695 | 42641183DA | 18 | 219.90 € | 1 | 695 |
| 41645185 | 37 | 299.90 € | 1 | 679 | 42613173 | 22 | 239.90 € | 1 | 695 | 42641184 | 18 | 169.90 € | 1 | 695 |
| 41645185DA | 37 | 339.90 € | 1 | 679 | 42613173DA | 22 | 299.90 € | 1 | 695 | 42641184DA | 18 | 219.90 € | 1 | 695 |
| 42611163 | 18 | 169.90 € | 1 | 695 | 42613174 | 22 | 239.90 € | 1 | 695 | 42641185 | 18 | 169.90 € | 1 | 695 |
| 42611163DA | 18 | 219.90 € | 1 | 695 | 42613174DA | 22 | 299.90 € | 1 | 695 | 42641185DA | 18 | 219.90 € | 1 | 695 |
| 42611164 | 18 | 169.90 € | 1 | 695 | 42613175 | 22 | 239.90 € | 1 | 695 | 42642163 | 20 | 199.90 € | 1 | 695 |
| 42611164DA | 18 | 219.90 € | 1 | 695 | 42613175DA | 22 | 299.90 € | 1 | 695 | 42642163DA | 20 | 259.90 € | 1 | 695 |
| 42611165 | 18 | 169.90 € | 1 | 695 | 42613183 | 22 | 239.90 € | 1 | 695 | 42642164 | 20 | 199.90 € | 1 | 695 |
| 42611165DA | 18 | 219.90 € | 1 | 695 | 42613183DA | 22 | 299.90 € | 1 | 695 | 42642164DA | 20 | 259.90 € | 1 | 695 |
| 42611173 | 18 | 169.90 € | 1 | 695 | 42613184 | 22 | 239.90 € | 1 | 695 | 42642165 | 20 | 199.90 € | 1 | 695 |
| 42611173DA | 18 | 219.90 € | 1 | 695 | 42613184DA | 22 | 299.90 € | 1 | 695 | 42642165DA | 20 | 259.90 € | 1 | 695 |
| 42611174 | 18 | 169.90 € | 1 | 695 | 42613185 | 22 | 239.90 € | 1 | 695 | 42642173 | 20 | 199.90 € | 1 | 695 |
| 42611174DA | 18 | 219.90 € | 1 | 695 | 42613185DA | 22 | 299.90 € | 1 | 695 | 42642173DA | 20 | 259.90 € | 1 | 695 |
| 42611175 | 18 | 169.90 € | 1 | 695 | 42614163 | 24 | 319.90 € | 1 | 695 | 42642174 | 20 | 199.90 € | 1 | 695 |
| 42611175DA | 18 | 219.90 € | 1 | 695 | 42614163DA | 24 | 379.90 € | 1 | 695 | 42642174DA | 20 | 259.90 € | 1 | 695 |
| 42611183 | 18 | 169.90 € | 1 | 695 | 42614164 | 24 | 319.90 € | 1 | 695 | 42642175 | 20 | 199.90 € | 1 | 695 |
| 42611183DA | 18 | 219.90 € | 1 | 695 | 42614164DA | 24 | 379.90 € | 1 | 695 | 42642175DA | 20 | 259.90 € | 1 | 695 |
| 42611184 | 18 | 169.90 € | 1 | 695 | 42614165 | 24 | 319.90 € | 1 | 695 | 42642183 | 20 | 199.90 € | 1 | 695 |
| 42611184DA | 18 | 219.90 € | 1 | 695 | 42614165DA | 24 | 379.90 € | 1 | 695 | 42642183DA | 20 | 259.90 € | 1 | 695 |
| 42611185 | 18 | 169.90 € | 1 | 695 | 42614173 | 24 | 319.90 € | 1 | 695 | 42642184 | 20 | 199.90 € | 1 | 695 |
| 42611185DA | 18 | 219.90 € | 1 | 695 | 42614173DA | 24 | 379.90 € | 1 | 695 | 42642184DA | 20 | 259.90 € | 1 | 695 |
| 42612163 | 20 | 199.90 € | 1 | 695 | 42614174 | 24 | 319.90 € | 1 | 695 | 42642185 | 20 | 199.90 € | 1 | 695 |
| 42612163DA | 20 | 259.90 € | 1 | 695 | 42614174DA | 24 | 379.90 € | 1 | 695 | 42642185DA | 20 | 259.90 € | 1 | 695 |
| 42612164 | 20 | 199.90 € | 1 | 695 | 42614175 | 24 | 319.90 € | 1 | 695 | 42643163 | 22 | 239.90 € | 1 | 695 |
| 42612164DA | 20 | 259.90 € | 1 | 695 | 42614175DA | 24 | 379.90 € | 1 | 695 | 42643163DA | 22 | 299.90 € | 1 | 695 |
| 42612165 | 20 | 199.90 € | 1 | 695 | 42614183 | 24 | 319.90 € | 1 | 695 | 42643164 | 22 | 239.90 € | 1 | 695 |
| 42612165DA | 20 | 259.90 € | 1 | 695 | 42614183DA | 24 | 379.90 € | 1 | 695 | 42643164DA | 22 | 299.90 € | 1 | 695 |
| 42612173 | 20 | 199.90 € | 1 | 695 | 42614184 | 24 | 319.90 € | 1 | 695 | 42643165 | 22 | 239.90 € | 1 | 695 |
| 42612173DA | 20 | 259.90 € | 1 | 695 | 42614184DA | 24 | 379.90 € | 1 | 695 | 42643165DA | 22 | 299.90 € | 1 | 695 |
| 42612174 | 20 | 199.90 € | 1 | 695 | 42614185 | 24 | 319.90 € | 1 | 695 | 42643173 | 22 | 239.90 € | 1 | 695 |
| 42612174DA | 20 | 259.90 € | 1 | 695 | 42614185DA | 24 | 379.90 € | 1 | 695 | 42643173DA | 22 | 299.90 € | 1 | 695 |
| 42612175 | 20 | 199.90 € | 1 | 695 | 42641163 | 18 | 169.90 € | 1 | 695 | 42643174 | 22 | 239.90 € | 1 | 695 |
| 42612175DA | 20 | 259.90 € | 1 | 695 | 42641163DA | 18 | 219.90 € | 1 | 695 | 42643174DA | 22 | 299.90 € | 1 | 695 |
| 42612183 | 20 | 199.90 € | 1 | 695 | 42641164 | 18 | 169.90 € | 1 | 695 | 42643175 | 22 | 239.90 € | 1 | 695 |

| Article no. | Page | Price in € | Discount group | Product group | Article no. | Page | Price in € | Discount group | Product group | Article no. | Page | Price in € | Discount group | Product group |
|-------------|------|------------|----------------|---------------|-------------|------|------------|----------------|---------------|-------------|------|------------|----------------|---------------|
| 42643175DA | 22 | 299.90 € | 1 | 695 | 43612163DA | 21 | 259.90 € | 1 | 695 | 43614174DA | 25 | 379.90 € | 1 | 695 |
| 42643183 | 22 | 239.90 € | 1 | 695 | 43612164 | 21 | 199.90 € | 1 | 695 | 43614175 | 25 | 319.90 € | 1 | 695 |
| 42643183DA | 22 | 299.90 € | 1 | 695 | 43612164DA | 21 | 259.90 € | 1 | 695 | 43614175DA | 25 | 379.90 € | 1 | 695 |
| 42643184 | 22 | 239.90 € | 1 | 695 | 43612165 | 21 | 199.90 € | 1 | 695 | 43614183 | 25 | 319.90 € | 1 | 695 |
| 42643184DA | 22 | 299.90 € | 1 | 695 | 43612165DA | 21 | 259.90 € | 1 | 695 | 43614183DA | 25 | 379.90 € | 1 | 695 |
| 42643185 | 22 | 239.90 € | 1 | 695 | 43612173 | 21 | 199.90 € | 1 | 695 | 43614184 | 25 | 319.90 € | 1 | 695 |
| 42643185DA | 22 | 299.90 € | 1 | 695 | 43612173DA | 21 | 259.90 € | 1 | 695 | 43614184DA | 25 | 379.90 € | 1 | 695 |
| 42644163 | 24 | 319.90 € | 1 | 695 | 43612174 | 21 | 199.90 € | 1 | 695 | 43614185 | 25 | 319.90 € | 1 | 695 |
| 42644163DA | 24 | 379.90 € | 1 | 695 | 43612174DA | 21 | 259.90 € | 1 | 695 | 43614185DA | 25 | 379.90 € | 1 | 695 |
| 42644164 | 24 | 319.90 € | 1 | 695 | 43612175 | 21 | 199.90 € | 1 | 695 | 43641163 | 19 | 169.90 € | 1 | 695 |
| 42644164DA | 24 | 379.90 € | 1 | 695 | 43612175DA | 21 | 259.90 € | 1 | 695 | 43641163DA | 19 | 219.90 € | 1 | 695 |
| 42644165 | 24 | 319.90 € | 1 | 695 | 43612183 | 21 | 199.90 € | 1 | 695 | 43641164 | 19 | 169.90 € | 1 | 695 |
| 42644165DA | 24 | 379.90 € | 1 | 695 | 43612183DA | 21 | 259.90 € | 1 | 695 | 43641164DA | 19 | 219.90 € | 1 | 695 |
| 42644173 | 24 | 319.90 € | 1 | 695 | 43612184 | 21 | 199.90 € | 1 | 695 | 43641165 | 19 | 169.90 € | 1 | 695 |
| 42644173DA | 24 | 379.90 € | 1 | 695 | 43612184DA | 21 | 259.90 € | 1 | 695 | 43641165DA | 19 | 219.90 € | 1 | 695 |
| 42644174 | 24 | 319.90 € | 1 | 695 | 43612185 | 21 | 199.90 € | 1 | 695 | 43641173 | 19 | 169.90 € | 1 | 695 |
| 42644174DA | 24 | 379.90 € | 1 | 695 | 43612185DA | 21 | 259.90 € | 1 | 695 | 43641173DA | 19 | 219.90 € | 1 | 695 |
| 42644175 | 24 | 319.90 € | 1 | 695 | 43613163 | 23 | 239.90 € | 1 | 695 | 43641174 | 19 | 169.90 € | 1 | 695 |
| 42644175DA | 24 | 379.90 € | 1 | 695 | 43613163DA | 23 | 299.90 € | 1 | 695 | 43641174DA | 19 | 219.90 € | 1 | 695 |
| 42644183 | 24 | 319.90 € | 1 | 695 | 43613164 | 23 | 239.90 € | 1 | 695 | 43641175 | 19 | 169.90 € | 1 | 695 |
| 42644183DA | 24 | 379.90 € | 1 | 695 | 43613164DA | 23 | 299.90 € | 1 | 695 | 43641175DA | 19 | 219.90 € | 1 | 695 |
| 42644184 | 24 | 319.90 € | 1 | 695 | 43613165 | 23 | 239.90 € | 1 | 695 | 43641183 | 19 | 169.90 € | 1 | 695 |
| 42644184DA | 24 | 379.90 € | 1 | 695 | 43613165DA | 23 | 299.90 € | 1 | 695 | 43641183DA | 19 | 219.90 € | 1 | 695 |
| 42644185 | 24 | 319.90 € | 1 | 695 | 43613173 | 23 | 239.90 € | 1 | 695 | 43641184 | 19 | 169.90 € | 1 | 695 |
| 42644185DA | 24 | 379.90 € | 1 | 695 | 43613173DA | 23 | 299.90 € | 1 | 695 | 43641184DA | 19 | 219.90 € | 1 | 695 |
| 43611163 | 19 | 169.90 € | 1 | 695 | 43613174 | 23 | 239.90 € | 1 | 695 | 43641185 | 19 | 169.90 € | 1 | 695 |
| 43611163DA | 19 | 219.90 € | 1 | 695 | 43613174DA | 23 | 299.90 € | 1 | 695 | 43641185DA | 19 | 219.90 € | 1 | 695 |
| 43611164 | 19 | 169.90 € | 1 | 695 | 43613175 | 23 | 239.90 € | 1 | 695 | 43642163 | 21 | 199.90 € | 1 | 695 |
| 43611164DA | 19 | 219.90 € | 1 | 695 | 43613175DA | 23 | 299.90 € | 1 | 695 | 43642163DA | 21 | 259.90 € | 1 | 695 |
| 43611165 | 19 | 169.90 € | 1 | 695 | 43613183 | 23 | 239.90 € | 1 | 695 | 43642164 | 21 | 199.90 € | 1 | 695 |
| 43611165DA | 19 | 219.90 € | 1 | 695 | 43613183DA | 23 | 299.90 € | 1 | 695 | 43642164DA | 21 | 259.90 € | 1 | 695 |
| 43611173 | 19 | 169.90 € | 1 | 695 | 43613184 | 23 | 239.90 € | 1 | 695 | 43642165 | 21 | 199.90 € | 1 | 695 |
| 43611173DA | 19 | 219.90 € | 1 | 695 | 43613184DA | 23 | 299.90 € | 1 | 695 | 43642165DA | 21 | 259.90 € | 1 | 695 |
| 43611174 | 19 | 169.90 € | 1 | 695 | 43613185 | 23 | 239.90 € | 1 | 695 | 43642173 | 21 | 199.90 € | 1 | 695 |
| 43611174DA | 19 | 219.90 € | 1 | 695 | 43613185DA | 23 | 299.90 € | 1 | 695 | 43642173DA | 21 | 259.90 € | 1 | 695 |
| 43611175 | 19 | 169.90 € | 1 | 695 | 43614163 | 25 | 319.90 € | 1 | 695 | 43642174 | 21 | 199.90 € | 1 | 695 |
| 43611175DA | 19 | 219.90 € | 1 | 695 | 43614163DA | 25 | 379.90 € | 1 | 695 | 43642174DA | 21 | 259.90 € | 1 | 695 |
| 43611183 | 19 | 169.90 € | 1 | 695 | 43614164 | 25 | 319.90 € | 1 | 695 | 43642175 | 21 | 199.90 € | 1 | 695 |
| 43611183DA | 19 | 219.90 € | 1 | 695 | 43614164DA | 25 | 379.90 € | 1 | 695 | 43642175DA | 21 | 259.90 € | 1 | 695 |
| 43611184 | 19 | 169.90 € | 1 | 695 | 43614165 | 25 | 319.90 € | 1 | 695 | 43642183 | 21 | 199.90 € | 1 | 695 |
| 43611184DA | 19 | 219.90 € | 1 | 695 | 43614165DA | 25 | 379.90 € | 1 | 695 | 43642183DA | 21 | 259.90 € | 1 | 695 |
| 43611185 | 19 | 169.90 € | 1 | 695 | 43614173 | 25 | 319.90 € | 1 | 695 | 43642184 | 21 | 199.90 € | 1 | 695 |
| 43611185DA | 19 | 219.90 € | 1 | 695 | 43614173DA | 25 | 379.90 € | 1 | 695 | 43642184DA | 21 | 259.90 € | 1 | 695 |
| 43612163 | 21 | 199.90 € | 1 | 695 | 43614174 | 25 | 319.90 € | 1 | 695 | 43642185 | 21 | 199.90 € | 1 | 695 |

| Article no. | Page | Price in € | Discount group | Product group | Article no. | Page | Price in € | Discount group | Product group | Article no. | Page | Price in € | Discount group | Product group |
|-------------|------|------------|----------------|---------------|-------------|------|------------|----------------|---------------|-------------|------|------------|----------------|---------------|
| 43642185DA | 21 | 259.90 € | 1 | 695 | 45201560 | 186 | 110.60 € | 1 | 688 | 53006000 | 245 | 43.50 € | 1 | 680 |
| 43643163 | 23 | 239.90 € | 1 | 695 | 45202170 | 187 | 110.60 € | 1 | 688 | 53007000 | 245 | 11.50 € | 1 | 680 |
| 43643163DA | 23 | 299.90 € | 1 | 695 | 45202180 | 187 | 110.60 € | 1 | 688 | 53010000 | 246 | 6.30 € | 1 | 680 |
| 43643164 | 23 | 239.90 € | 1 | 695 | 45202550 | 187 | 110.60 € | 1 | 688 | 53012000 | 246 | 17.90 € | 1 | 680 |
| 43643164DA | 23 | 299.90 € | 1 | 695 | 45202560 | 187 | 110.60 € | 1 | 688 | 53013000 | 246 | 14.90 € | 1 | 680 |
| 43643165 | 23 | 239.90 € | 1 | 695 | 45203170 | 192 | 110.60 € | 1 | 688 | 53056070 | 244 | 4.90 € | 1 | 680 |
| 43643165DA | 23 | 299.90 € | 1 | 695 | 45203180 | 192 | 110.60 € | 1 | 688 | 53056070 | 245 | 4.90 € | 1 | 680 |
| 43643173 | 23 | 239.90 € | 1 | 695 | 45203550 | 192 | 110.60 € | 1 | 688 | 53056070 | 246 | 4.90 € | 1 | 680 |
| 43643173DA | 23 | 299.90 € | 1 | 695 | 45203560 | 192 | 110.60 € | 1 | 688 | 53057070 | 245 | 4.10 € | 1 | 680 |
| 43643174 | 23 | 239.90 € | 1 | 695 | 45204170 | 192 | 110.60 € | 1 | 688 | 53057080 | 245 | 4.10 € | 1 | 680 |
| 43643174DA | 23 | 299.90 € | 1 | 695 | 45204180 | 192 | 110.60 € | 1 | 688 | 53057260 | 245 | 4.10 € | 1 | 680 |
| 43643175 | 23 | 239.90 € | 1 | 695 | 45204550 | 192 | 110.60 € | 1 | 688 | 53066070 | 246 | 4.90 € | 1 | 680 |
| 43643175DA | 23 | 299.90 € | 1 | 695 | 45204560 | 192 | 110.60 € | 1 | 688 | 53066080 | 246 | 4.90 € | 1 | 680 |
| 43643183 | 23 | 239.90 € | 1 | 695 | 45205170 | 193 | 110.60 € | 1 | 688 | 53066260 | 246 | 4.90 € | 1 | 680 |
| 43643183DA | 23 | 299.90 € | 1 | 695 | 45205180 | 193 | 110.60 € | 1 | 688 | 53073070 | 244 | 3.30 € | 1 | 680 |
| 43643184 | 23 | 239.90 € | 1 | 695 | 45205550 | 193 | 110.60 € | 1 | 688 | 53073080 | 244 | 3.30 € | 1 | 680 |
| 43643184DA | 23 | 299.90 € | 1 | 695 | 45205560 | 193 | 110.60 € | 1 | 688 | 53073260 | 244 | 3.30 € | 1 | 680 |
| 43643185 | 23 | 239.90 € | 1 | 695 | 45206170 | 188 | 101.10 € | 1 | 688 | 53250100 | 249 | 9.00 € | 1 | 680 |
| 43643185DA | 23 | 299.90 € | 1 | 695 | 45206180 | 188 | 101.10 € | 1 | 688 | 53250200 | 249 | 9.00 € | 1 | 680 |
| 43644163 | 25 | 319.90 € | 1 | 695 | 45206550 | 188 | 101.10 € | 1 | 688 | 53251100 | 251 | 10.00 € | 1 | 680 |
| 43644163DA | 25 | 379.90 € | 1 | 695 | 45206560 | 188 | 101.10 € | 1 | 688 | 53251200 | 251 | 10.00 € | 1 | 680 |
| 43644164 | 25 | 319.90 € | 1 | 695 | 45207170 | 188 | 101.10 € | 1 | 688 | 53252100 | 253 | 12.00 € | 1 | 680 |
| 43644164DA | 25 | 379.90 € | 1 | 695 | 45207180 | 188 | 101.10 € | 1 | 688 | 53252200 | 253 | 12.00 € | 1 | 680 |
| 43644165 | 25 | 319.90 € | 1 | 695 | 45207550 | 188 | 101.10 € | 1 | 688 | 53253000 | 249 | 6.00 € | 1 | 680 |
| 43644165DA | 25 | 379.90 € | 1 | 695 | 45207560 | 188 | 101.10 € | 1 | 688 | 53253000 | 251 | 6.00 € | 1 | 680 |
| 43644173 | 25 | 319.90 € | 1 | 695 | 45208170 | 189 | 101.10 € | 1 | 688 | 53253000 | 253 | 6.00 € | 1 | 680 |
| 43644173DA | 25 | 379.90 € | 1 | 695 | 45208180 | 189 | 101.10 € | 1 | 688 | 53254000 | 255 | 6.00 € | 1 | 680 |
| 43644174 | 25 | 319.90 € | 1 | 695 | 45208550 | 189 | 101.10 € | 1 | 688 | 53254000 | 257 | 6.00 € | 1 | 680 |
| 43644174DA | 25 | 379.90 € | 1 | 695 | 45208560 | 189 | 101.10 € | 1 | 688 | 53254000 | 259 | 6.00 € | 1 | 680 |
| 43644175 | 25 | 319.90 € | 1 | 695 | 45210170 | 190 | 101.10 € | 1 | 688 | 53255100 | 255 | 9.00 € | 1 | 680 |
| 43644175DA | 25 | 379.90 € | 1 | 695 | 45210180 | 190 | 101.10 € | 1 | 688 | 53255200 | 255 | 9.00 € | 1 | 680 |
| 43644183 | 25 | 319.90 € | 1 | 695 | 45210550 | 190 | 101.10 € | 1 | 688 | 53256100 | 257 | 10.00 € | 1 | 680 |
| 43644183DA | 25 | 379.90 € | 1 | 695 | 45210560 | 190 | 101.10 € | 1 | 688 | 53256200 | 257 | 10.00 € | 1 | 680 |
| 43644184 | 25 | 319.90 € | 1 | 695 | 45211170 | 190 | 101.10 € | 1 | 688 | 53257100 | 259 | 12.00 € | 1 | 680 |
| 43644184DA | 25 | 379.90 € | 1 | 695 | 45211180 | 190 | 101.10 € | 1 | 688 | 53257200 | 259 | 12.00 € | 1 | 680 |
| 43644185 | 25 | 319.90 € | 1 | 695 | 45211550 | 190 | 101.10 € | 1 | 688 | 53258000 | 249 | 13.00 € | 1 | 680 |
| 43644185DA | 25 | 379.90 € | 1 | 695 | 45211560 | 190 | 101.10 € | 1 | 688 | 53258000 | 251 | 13.00 € | 1 | 680 |
| 45200170 | 186 | 110.60 € | 1 | 688 | 45212170 | 191 | 101.10 € | 1 | 688 | 53258000 | 253 | 13.00 € | 1 | 680 |
| 45200180 | 186 | 110.60 € | 1 | 688 | 45212180 | 191 | 101.10 € | 1 | 688 | 53259000 | 255 | 13.00 € | 1 | 680 |
| 45200550 | 186 | 110.60 € | 1 | 688 | 45212550 | 191 | 101.10 € | 1 | 688 | 53259000 | 257 | 13.00 € | 1 | 680 |
| 45200560 | 186 | 110.60 € | 1 | 688 | 45212560 | 191 | 101.10 € | 1 | 688 | 53259000 | 259 | 13.00 € | 1 | 680 |
| 45201170 | 186 | 110.60 € | 1 | 688 | 53003000 | 244 | 5.30 € | 1 | 680 | 53402000 | 244 | 22.70 € | 1 | 680 |
| 45201180 | 186 | 110.60 € | 1 | 688 | 53003000 | 245 | 5.30 € | 1 | 680 | 53402000 | 245 | 22.70 € | 1 | 680 |
| 45201550 | 186 | 110.60 € | 1 | 688 | 53004000 | 244 | 4.20 € | 1 | 680 | 53402000 | 246 | 22.70 € | 1 | 680 |

| Article no. | Page | Price in € | Discount group | Product group | Article no. | Page | Price in € | Discount group | Product group | Article no. | Page | Price in € | Discount group | Product group |
|-------------|------|------------|----------------|---------------|-------------|------|------------|----------------|---------------|-------------|------|------------|----------------|---------------|
| 53402070 | 244 | 22.70 € | 1 | 680 | 60046103 | 431 | 399.90 € | 1 | 693 | 60804643 | 217 | 549.90 € | 2 | 2869 |
| 53402070 | 245 | 22.70 € | 1 | 680 | 60056103 | 431 | 449.90 € | 1 | 693 | 60804643 | 437 | 549.90 € | 2 | 2869 |
| 53402070 | 246 | 22.70 € | 1 | 680 | 60070180 | 424 | 299.90 € | 1 | 693 | 60804644 | 217 | 549.90 € | 2 | 2869 |
| 53402080 | 244 | 22.70 € | 1 | 680 | 60103223 | 396 | 239.90 € | 1 | 693 | 60804644 | 437 | 549.90 € | 2 | 2869 |
| 53402080 | 245 | 22.70 € | 1 | 680 | 60104183 | 396 | 319.90 € | 1 | 693 | 60805643 | 217 | 692.90 € | 2 | 2869 |
| 53402080 | 246 | 22.70 € | 1 | 680 | 60107183 | 314 | 219.90 € | 1 | 693 | 60805643 | 437 | 692.90 € | 2 | 2869 |
| 53432070 | 244 | 50.10 € | 1 | 680 | 60107183 | 367 | 219.90 € | 1 | 693 | 60805644 | 217 | 692.90 € | 2 | 2869 |
| 53432070 | 245 | 50.10 € | 1 | 680 | 60108183 | 314 | 229.90 € | 1 | 693 | 60805644 | 437 | 692.90 € | 2 | 2869 |
| 53432070 | 246 | 50.10 € | 1 | 680 | 60108183 | 367 | 229.90 € | 1 | 693 | 60806643 | 217 | 692.90 € | 2 | 2869 |
| 53580260 | 249 | 18.50 € | 1 | 680 | 60110103 | 353 | 289.90 € | 1 | 693 | 60806643 | 437 | 692.90 € | 2 | 2869 |
| 53580260 | 251 | 18.50 € | 1 | 680 | 60111103 | 403 | 259.90 € | 1 | 693 | 60806644 | 217 | 692.90 € | 2 | 2869 |
| 53580260 | 253 | 18.50 € | 1 | 680 | 60112103 | 403 | 439.90 € | 1 | 693 | 60806644 | 437 | 692.90 € | 2 | 2869 |
| 53581260 | 255 | 20.50 € | 1 | 680 | 60113183 | 397 | 229.90 € | 1 | 693 | 60807643 | 217 | 1,399.90 € | 2 | 2869 |
| 53581260 | 257 | 20.50 € | 1 | 680 | 60115103 | 311 | 239.90 € | 1 | 693 | 60807643 | 437 | 1,399.90 € | 2 | 2869 |
| 53581260 | 259 | 20.50 € | 1 | 680 | 60116103 | 311 | 389.90 € | 1 | 693 | 60807644 | 217 | 1,399.90 € | 2 | 2869 |
| 53582260 | 255 | 23.20 € | 1 | 680 | 60117183 | 397 | 219.90 € | 1 | 693 | 60807644 | 437 | 1,399.90 € | 2 | 2869 |
| 53582260 | 259 | 23.20 € | 1 | 680 | 60118183 | 397 | 239.90 € | 1 | 693 | 60808643 | 217 | 1,399.90 € | 2 | 2869 |
| 53603070 | 245 | 57.10 € | 1 | 680 | 60119183 | 339 | | | #N/A | 60808643 | 437 | 1,399.90 € | 2 | 2869 |
| 53603080 | 245 | 57.10 € | 1 | 680 | 60120103 | 422 | 359.90 € | 1 | 693 | 60808644 | 217 | 1,399.90 € | 2 | 2869 |
| 53603260 | 245 | 36.80 € | 1 | 680 | 60121103 | 429 | 299.90 € | 1 | 693 | 60808644 | 437 | 1,399.90 € | 2 | 2869 |
| 53654070 | 246 | 45.30 € | 1 | 680 | 60122103 | 393 | 399.90 € | 1 | 693 | 60809643 | 217 | 1,449.90 € | 2 | 2869 |
| 53654080 | 246 | 45.30 € | 1 | 680 | 60127173 | 362 | 179.90 € | 1 | 679 | 60809643 | 437 | 1,449.90 € | 2 | 2869 |
| 53654260 | 246 | 40.30 € | 1 | 680 | 60127183 | 362 | 179.90 € | 1 | 679 | 60809644 | 217 | 1,449.90 € | 2 | 2869 |
| 53702070 | 244 | 54.30 € | 1 | 680 | 60127253 | 362 | 179.90 € | 1 | 679 | 60809644 | 437 | 1,449.90 € | 2 | 2869 |
| 53702080 | 244 | 54.30 € | 1 | 680 | 60140180 | 363 | 169.90 € | 1 | 679 | 60810643 | 217 | 1,449.90 € | 2 | 2869 |
| 53702260 | 244 | 36.90 € | 1 | 680 | 60141180 | 312 | 129.90 € | 1 | 679 | 60810643 | 437 | 1,449.90 € | 2 | 2869 |
| 53756070 | 245 | 25.20 € | 1 | 680 | 60205183 | 319 | 244.90 € | 1 | 693 | 60810644 | 217 | 1,449.90 € | 2 | 2869 |
| 53756080 | 245 | 26.80 € | 1 | 680 | 60208183 | 319 | 219.90 € | 1 | 693 | 60810644 | 437 | 1,449.90 € | 2 | 2869 |
| 53756260 | 245 | 20.20 € | 1 | 680 | 60210183 | 318 | 169.90 € | 1 | 693 | 60811183 | 439 | 24.90 € | 2 | 2869 |
| 60006103 | 423 | 249.90 € | 1 | 693 | 60211183 | 318 | 229.90 € | 1 | 693 | 60811184 | 439 | 24.90 € | 2 | 2869 |
| 60007103 | 424 | 329.90 € | 1 | 693 | 60331183 | 378 | 99.90 € | 1 | 693 | 60812183 | 439 | 34.90 € | 2 | 2869 |
| 60019183 | 407 | 189.90 € | 1 | 693 | 60332183 | 379 | 99.90 € | 1 | 693 | 60812184 | 439 | 34.90 € | 2 | 2869 |
| 60020103 | 401 | 99.90 € | 1 | 693 | 60801643 | 217 | 329.90 € | 2 | 2869 | 60813183 | 439 | 79.90 € | 2 | 2869 |
| 60021103 | 401 | 119.90 € | 1 | 693 | 60801643 | 437 | 329.90 € | 2 | 2869 | 60813184 | 439 | 79.90 € | 2 | 2869 |
| 60022103 | 401 | 139.90 € | 1 | 693 | 60801644 | 217 | 329.90 € | 2 | 2869 | 60831642 | 226 | 399.90 € | 2 | 2869 |
| 60025183 | 355 | 189.90 € | 1 | 693 | 60801644 | 437 | 329.90 € | 2 | 2869 | 60831643 | 226 | 349.90 € | 2 | 2869 |
| 60026183 | 355 | 199.90 € | 1 | 693 | 60802643 | 217 | 329.90 € | 2 | 2869 | 60831644 | 226 | 349.90 € | 2 | 2869 |
| 60029183 | 407 | 229.90 € | 1 | 693 | 60802643 | 437 | 329.90 € | 2 | 2869 | 60831645 | 226 | 349.90 € | 2 | 2869 |
| 60036103 | 423 | 389.90 € | 1 | 693 | 60802644 | 217 | 329.90 € | 2 | 2869 | 60831646 | 226 | 349.90 € | 2 | 2869 |
| 60039183 | 407 | 269.90 € | 1 | 693 | 60802644 | 437 | 329.90 € | 2 | 2869 | 60831647 | 226 | 349.90 € | 2 | 2869 |
| 60040103 | 341 | 189.90 € | 1 | 693 | 60803643 | 217 | 549.90 € | 2 | 2869 | 60832642 | 226 | 399.90 € | 2 | 2869 |
| 60041103 | 341 | 209.90 € | 1 | 693 | 60803643 | 437 | 549.90 € | 2 | 2869 | 60832643 | 226 | 349.90 € | 2 | 2869 |
| 60042103 | 341 | 229.90 € | 1 | 693 | 60803644 | 217 | 549.90 € | 2 | 2869 | 60832644 | 226 | 349.90 € | 2 | 2869 |
| 60043103 | 341 | 249.90 € | 1 | 693 | 60803644 | 437 | 549.90 € | 2 | 2869 | 60832645 | 226 | 349.90 € | 2 | 2869 |

| Article no. | Page | Price in € | Discount group | Product group | Article no. | Page | Price in € | Discount group | Product group | Article no. | Page | Price in € | Discount group | Product group |
|-------------|------|------------|----------------|---------------|-------------|------|------------|----------------|---------------|-------------|------|------------|----------------|---------------|
| 60832646 | 226 | 349.90 € | 2 | 2869 | 60852642 | 228 | 599.90 € | 2 | 2869 | 60871644 | 231 | 449.90 € | 2 | 2869 |
| 60832647 | 226 | 349.90 € | 2 | 2869 | 60852643 | 228 | 549.90 € | 2 | 2869 | 60871645 | 231 | 449.90 € | 2 | 2869 |
| 60833642 | 226 | 399.90 € | 2 | 2869 | 60852644 | 228 | 549.90 € | 2 | 2869 | 60871646 | 231 | 449.90 € | 2 | 2869 |
| 60833643 | 226 | 349.90 € | 2 | 2869 | 60852645 | 228 | 549.90 € | 2 | 2869 | 60871647 | 231 | 449.90 € | 2 | 2869 |
| 60833644 | 226 | 349.90 € | 2 | 2869 | 60852646 | 228 | 549.90 € | 2 | 2869 | 60872642 | 231 | 499.90 € | 2 | 2869 |
| 60833645 | 226 | 349.90 € | 2 | 2869 | 60852647 | 228 | 549.90 € | 2 | 2869 | 60872643 | 231 | 449.90 € | 2 | 2869 |
| 60833646 | 226 | 349.90 € | 2 | 2869 | 60853642 | 228 | 599.90 € | 2 | 2869 | 60872644 | 231 | 449.90 € | 2 | 2869 |
| 60833647 | 226 | 349.90 € | 2 | 2869 | 60853643 | 228 | 549.90 € | 2 | 2869 | 60872645 | 231 | 449.00 € | 2 | 2869 |
| 60835642 | 226 | 399.90 € | 2 | 2869 | 60853644 | 228 | 549.90 € | 2 | 2869 | 60872646 | 231 | 449.00 € | 2 | 2869 |
| 60835643 | 226 | 349.90 € | 2 | 2869 | 60853645 | 228 | 549.90 € | 2 | 2869 | 60872647 | 231 | 449.90 € | 2 | 2869 |
| 60835644 | 226 | 349.90 € | 2 | 2869 | 60853646 | 228 | 549.90 € | 2 | 2869 | 60873642 | 231 | 499.90 € | 2 | 2869 |
| 60835645 | 226 | 349.90 € | 2 | 2869 | 60853647 | 228 | 549.90 € | 2 | 2869 | 60873643 | 231 | 449.90 € | 2 | 2869 |
| 60835646 | 226 | 349.90 € | 2 | 2869 | 60855642 | 228 | 599.90 € | 2 | 2869 | 60873644 | 231 | 449.90 € | 2 | 2869 |
| 60835647 | 226 | 349.90 € | 2 | 2869 | 60855643 | 228 | 549.90 € | 2 | 2869 | 60873645 | 231 | 449.90 € | 2 | 2869 |
| 60841642 | 227 | 499.90 € | 2 | 2869 | 60855644 | 228 | 549.90 € | 2 | 2869 | 60873646 | 231 | 449.90 € | 2 | 2869 |
| 60841643 | 227 | 449.90 € | 2 | 2869 | 60855645 | 228 | 549.90 € | 2 | 2869 | 60873647 | 231 | 449.90 € | 2 | 2869 |
| 60841644 | 227 | 449.90 € | 2 | 2869 | 60855646 | 228 | 549.90 € | 2 | 2869 | 60875642 | 231 | 499.90 € | 2 | 2869 |
| 60841645 | 227 | 449.90 € | 2 | 2869 | 60855647 | 228 | 549.90 € | 2 | 2869 | 60875643 | 231 | 449.90 € | 2 | 2869 |
| 60841646 | 227 | 449.90 € | 2 | 2869 | 60861642 | 229 | 699.90 € | 2 | 2869 | 60875644 | 231 | 449.90 € | 2 | 2869 |
| 60841647 | 227 | 449.90 € | 2 | 2869 | 60861643 | 229 | 649.90 € | 2 | 2869 | 60875645 | 231 | 449.90 € | 2 | 2869 |
| 60842642 | 227 | 499.90 € | 2 | 2869 | 60861644 | 229 | 649.90 € | 2 | 2869 | 60875646 | 231 | 449.90 € | 2 | 2869 |
| 60842643 | 227 | 449.90 € | 2 | 2869 | 60861645 | 229 | 649.90 € | 2 | 2869 | 60875647 | 231 | 449.90 € | 2 | 2869 |
| 60842644 | 227 | 449.90 € | 2 | 2869 | 60861646 | 229 | 649.90 € | 2 | 2869 | 60881642 | 232 | 699.90 € | 2 | 2869 |
| 60842645 | 227 | 449.90 € | 2 | 2869 | 60861647 | 229 | 649.90 € | 2 | 2869 | 60881643 | 232 | 549.90 € | 2 | 2869 |
| 60842646 | 227 | 449.90 € | 2 | 2869 | 60862642 | 229 | 699.90 € | 2 | 2869 | 60881644 | 232 | 549.90 € | 2 | 2869 |
| 60842647 | 227 | 449.90 € | 2 | 2869 | 60862643 | 229 | 649.90 € | 2 | 2869 | 60881645 | 232 | 549.90 € | 2 | 2869 |
| 60843642 | 227 | 499.90 € | 2 | 2869 | 60862644 | 229 | 649.90 € | 2 | 2869 | 60881646 | 232 | 549.90 € | 2 | 2869 |
| 60843643 | 227 | 449.90 € | 2 | 2869 | 60862645 | 229 | 649.90 € | 2 | 2869 | 60881647 | 232 | 549.90 € | 2 | 2869 |
| 60843644 | 227 | 449.90 € | 2 | 2869 | 60862646 | 229 | 649.90 € | 2 | 2869 | 60882642 | 232 | 699.90 € | 2 | 2869 |
| 60843645 | 227 | 449.90 € | 2 | 2869 | 60862647 | 229 | 649.90 € | 2 | 2869 | 60882643 | 232 | 549.90 € | 2 | 2869 |
| 60843646 | 227 | 449.90 € | 2 | 2869 | 60863642 | 229 | 699.90 € | 2 | 2869 | 60882644 | 232 | 549.90 € | 2 | 2869 |
| 60843647 | 227 | 449.90 € | 2 | 2869 | 60863643 | 229 | 649.90 € | 2 | 2869 | 60882645 | 232 | 549.90 € | 2 | 2869 |
| 60845642 | 227 | 499.90 € | 2 | 2869 | 60863644 | 229 | 649.90 € | 2 | 2869 | 60882646 | 232 | 549.90 € | 2 | 2869 |
| 60845643 | 227 | 449.90 € | 2 | 2869 | 60863645 | 229 | 649.90 € | 2 | 2869 | 60882647 | 232 | 549.90 € | 2 | 2869 |
| 60845644 | 227 | 449.90 € | 2 | 2869 | 60863646 | 229 | 649.90 € | 2 | 2869 | 60883642 | 232 | 699.90 € | 2 | 2869 |
| 60845645 | 227 | 449.90 € | 2 | 2869 | 60863647 | 229 | 649.90 € | 2 | 2869 | 60883643 | 232 | 549.90 € | 2 | 2869 |
| 60845646 | 227 | 449.90 € | 2 | 2869 | 60865642 | 229 | 699.90 € | 2 | 2869 | 60883644 | 232 | 549.90 € | 2 | 2869 |
| 60845647 | 227 | 449.90 € | 2 | 2869 | 60865643 | 229 | 649.90 € | 2 | 2869 | 60883645 | 232 | 549.90 € | 2 | 2869 |
| 60851642 | 228 | 599.90 € | 2 | 2869 | 60865644 | 229 | 649.90 € | 2 | 2869 | 60883646 | 232 | 549.90 € | 2 | 2869 |
| 60851643 | 228 | 549.90 € | 2 | 2869 | 60865645 | 229 | 649.90 € | 2 | 2869 | 60883647 | 232 | 549.90 € | 2 | 2869 |
| 60851644 | 228 | 549.90 € | 2 | 2869 | 60865646 | 229 | 649.90 € | 2 | 2869 | 60885642 | 232 | 699.90 € | 2 | 2869 |
| 60851645 | 228 | 549.90 € | 2 | 2869 | 60865647 | 229 | 649.90 € | 2 | 2869 | 60885643 | 232 | 549.90 € | 2 | 2869 |
| 60851646 | 228 | 549.90 € | 2 | 2869 | 60871642 | 231 | 499.90 € | 2 | 2869 | 60885644 | 232 | 549.90 € | 2 | 2869 |
| 60851647 | 228 | 549.90 € | 2 | 2869 | 60871643 | 231 | 449.90 € | 2 | 2869 | 60885645 | 232 | 549.90 € | 2 | 2869 |

| Article no. | Page | Price in € | Discount group | Product group | Article no. | Page | Price in € | Discount group | Product group | Article no. | Page | Price in € | Discount group | Product group |
|-------------|------|------------|----------------|---------------|-------------|------|------------|----------------|---------------|-------------|------|------------|----------------|---------------|
| 60885646 | 232 | 549.90 € | 2 | 2869 | 65141103 | 356 | 150.10 € | 1 | 2973 | 65331180 | 331 | 69.90 € | 1 | 2973 |
| 60885647 | 232 | 549.90 € | 2 | 2869 | 65142103 | 356 | 179.00 € | 1 | 2973 | 65332180 | 331 | 79.90 € | 1 | 2973 |
| 60891642 | 233 | 999.90 € | 2 | 2869 | 65143103 | 356 | 139.00 € | 1 | 2973 | 65341180 | 331 | 69.90 € | 1 | 2973 |
| 60891643 | 233 | 899.90 € | 2 | 2869 | 65144103 | 356 | 152.10 € | 1 | 2973 | 65342180 | 331 | 79.90 € | 1 | 2973 |
| 60891644 | 233 | 899.90 € | 2 | 2869 | 65151103 | 357 | 139.00 € | 1 | 2973 | 65351100 | 333 | 79.90 € | 1 | 2973 |
| 60891645 | 233 | 899.90 € | 2 | 2869 | 65161103 | 349 | 272.70 € | 1 | 2973 | 65352100 | 333 | 69.90 € | 1 | 2973 |
| 60891646 | 233 | 899.90 € | 2 | 2869 | 65162103 | 349 | 205.70 € | 1 | 2973 | 65353100 | 333 | 74.90 € | 1 | 2973 |
| 60891647 | 233 | 899.90 € | 2 | 2869 | 65171103 | 351 | 293.40 € | 1 | 2973 | 65361100 | 426 | 119.90 € | 1 | 2973 |
| 60892642 | 233 | 999.90 € | 2 | 2869 | 65172103 | 351 | 334.40 € | 1 | 2973 | 65362100 | 426 | 139.90 € | 1 | 2973 |
| 60892643 | 233 | 899.90 € | 2 | 2869 | 65181103 | 412 | 230.90 € | 1 | 2973 | 65363100 | 426 | 149.90 € | 1 | 2973 |
| 60892644 | 233 | 899.90 € | 2 | 2869 | 65182103 | 412 | 263.00 € | 1 | 2973 | 65364100 | 426 | 129.90 € | 1 | 2973 |
| 60892645 | 233 | 899.90 € | 2 | 2869 | 65191103 | 413 | 201.30 € | 1 | 2973 | 65371180 | 427 | 129.90 € | 1 | 2973 |
| 60892646 | 233 | 899.90 € | 2 | 2869 | 65192103 | 413 | 252.20 € | 1 | 2973 | 65372180 | 427 | 149.90 € | 1 | 2973 |
| 60892647 | 233 | 899.90 € | 2 | 2869 | 65201103 | 433 | 219.30 € | 1 | 2973 | 65373180 | 427 | 179.90 € | 1 | 2973 |
| 60893642 | 233 | 999.90 € | 2 | 2869 | 65202103 | 433 | 235.10 € | 1 | 2973 | 65381103 | 335 | 139.90 € | 1 | 2973 |
| 60893643 | 233 | 899.90 € | 2 | 2869 | 65211103 | 416 | 242.20 € | 1 | 2973 | 65382103 | 409 | 159.90 € | 1 | 2973 |
| 60893644 | 233 | 899.90 € | 2 | 2869 | 65212103 | 416 | 422.00 € | 1 | 2973 | 65383103 | 409 | 179.90 € | 1 | 2973 |
| 60893645 | 233 | 899.90 € | 2 | 2869 | 65221103 | 417 | 200.30 € | 1 | 2973 | 65391100 | 429 | 169.90 € | 1 | 2973 |
| 60893646 | 233 | 899.90 € | 2 | 2869 | 65222103 | 417 | 225.30 € | 1 | 2973 | 65401003BL | 205 | 89.90 € | 1 | 2983 |
| 60893647 | 233 | 899.90 € | 2 | 2869 | 65231103 | 358 | 192.90 € | 1 | 2973 | 65401003GE | 205 | 89.90 € | 1 | 2983 |
| 60895642 | 233 | 999.90 € | 2 | 2869 | 65232103 | 358 | 167.20 € | 1 | 2973 | 65401003OR | 205 | 89.90 € | 1 | 2983 |
| 60895643 | 233 | 899.90 € | 2 | 2869 | 65233103 | 358 | 233.70 € | 1 | 2973 | 65401003PI | 205 | 89.90 € | 1 | 2983 |
| 60895644 | 233 | 899.90 € | 2 | 2869 | 65234103 | 359 | 172.40 € | 1 | 2973 | 65401003SB | 205 | 89.90 € | 1 | 2983 |
| 60895645 | 233 | 899.90 € | 2 | 2869 | 65235103 | 359 | 167.20 € | 1 | 2973 | 65401003SG | 205 | 89.90 € | 1 | 2983 |
| 60895646 | 233 | 899.90 € | 2 | 2869 | 65236103 | 359 | 206.60 € | 1 | 2973 | 65401123 | 205 | 89.90 € | 1 | 2983 |
| 60895647 | 233 | 899.90 € | 2 | 2869 | 65237103 | 359 | 171.30 € | 1 | 2973 | 65401183 | 205 | 89.90 € | 1 | 2983 |
| 65011103 | 343 | 121.60 € | 1 | 2973 | 65241103 | 361 | 155.00 € | 1 | 2973 | 65411003PI | 205 | 99.90 € | 1 | 2983 |
| 65021103 | 343 | 163.00 € | 1 | 2973 | 65251103 | 364 | 150.60 € | 1 | 2973 | 65411003SB | 205 | 99.90 € | 1 | 2983 |
| 65031103 | 343 | 115.30 € | 1 | 2973 | 65252103 | 364 | 197.60 € | 1 | 2973 | 65411123 | 205 | 99.90 € | 1 | 2983 |
| 65041103 | 343 | 161.80 € | 1 | 2973 | 65253103 | 364 | 222.30 € | 1 | 2973 | 65411183 | 205 | 99.90 € | 1 | 2983 |
| 65051103 | 344 | 147.40 € | 1 | 2973 | 65254103 | 365 | 235.60 € | 1 | 2973 | 65421100 | 433 | 159.90 € | 1 | 2973 |
| 65061103 | 344 | 116.80 € | 1 | 2973 | 65255103 | 365 | 299.40 € | 1 | 2973 | 65422100 | 433 | 179.90 € | 1 | 2973 |
| 65071103 | 344 | 229.90 € | 1 | 2973 | 65261103 | 410 | 230.40 € | 1 | 2973 | 65431220 | 431 | 299.90 € | 1 | 2973 |
| 65081103 | 345 | 238.40 € | 1 | 2973 | 65262103 | 410 | 250.60 € | 1 | 2973 | 65441220 | 431 | 339.90 € | 1 | 2973 |
| 65091103 | 361 | 221.30 € | 1 | 2973 | 65263103 | 411 | 253.00 € | 1 | 2973 | 75316004 | 242 | 3.20 € | 1 | 756 |
| 65101103 | 429 | 317.10 € | 1 | 2973 | 65271103 | 398 | 234.00 € | 1 | 2973 | 75317003 | 241 | 3.50 € | 1 | 756 |
| 65111103 | 346 | 242.50 € | 1 | 2973 | 65272103 | 398 | 216.30 € | 1 | 2973 | 75317004 | 241 | 3.50 € | 1 | 756 |
| 65112103 | 421 | 289.10 € | 1 | 2973 | 65281103 | 373 | 240.70 € | 1 | 2973 | 75317027 | 241 | 3.50 € | 1 | 756 |
| 65113103 | 346 | 201.00 € | 1 | 2973 | 65291103 | 373 | 213.00 € | 1 | 2973 | 75376004 | 242 | 4.10 € | 1 | 756 |
| 65121103 | 347 | 241.50 € | 1 | 2973 | 65301103 | 376 | 252.60 € | 1 | 2973 | 75377003 | 241 | 3.70 € | 1 | 756 |
| 65122103 | 421 | 291.00 € | 1 | 2973 | 65311103 | 374 | 325.40 € | 1 | 2973 | 75377004 | 241 | 3.70 € | 1 | 756 |
| 65123103 | 347 | 209.00 € | 1 | 2973 | 65312103 | 375 | 339.50 € | 1 | 2973 | 75377027 | 241 | 3.70 € | 1 | 756 |
| 65131103 | 345 | 239.50 € | 1 | 2973 | 65321103 | 377 | 231.80 € | 1 | 2973 | 75503003 | 238 | 2,35 € | 1 | 756 |
| 65132103 | 419 | 315.50 € | 1 | 2973 | 65322103 | 377 | 237.80 € | 1 | 2973 | 75503004 | 238 | 2,35 € | 1 | 756 |

| Article no. | Page | Price in € | Discount group | Product group | Article no. | Page | Price in € | Discount group | Product group | Article no. | Page | Price in € | Discount group | Product group |
|-------------|------|------------|----------------|---------------|-------------|------|------------|----------------|---------------|-------------|------|------------|----------------|---------------|
| 75503027 | 238 | 2,35 € | 1 | 756 | 75998000 | 242 | 15.90 € | 1 | 756 | 77024073 | 126 | 689.90 € | 2 | 2637 |
| 75504003 | 239 | 2,15 € | 1 | 756 | 75998000 | 243 | 15.90 € | 1 | 756 | 77024074 | 126 | 689.90 € | 2 | 2637 |
| 75504004 | 239 | 2,15 € | 1 | 756 | 75999000 | 236 | 23.90 € | 1 | 756 | 77024078 | 126 | 899.90 € | 2 | 2637 |
| 75504027 | 239 | 2,15 € | 1 | 756 | 75999000 | 236 | 23.90 € | 1 | 756 | 77024083 | 126 | 689.90 € | 2 | 2637 |
| 75507002 | 243 | 8.80 € | 1 | 756 | 75999000 | 237 | 23.90 € | 1 | 756 | 77024084 | 126 | 689.90 € | 2 | 2637 |
| 75521003 | 236 | 4.60 € | 1 | 756 | 75999000 | 237 | 23.90 € | 1 | 756 | 77024088 | 126 | 899.90 € | 2 | 2637 |
| 75521004 | 236 | 4.60 € | 1 | 756 | 75999000 | 238 | 23.90 € | 1 | 756 | 77024693 | 126 | 689.90 € | 2 | 2637 |
| 75521027 | 236 | 4.60 € | 1 | 756 | 75999000 | 238 | 23.90 € | 1 | 756 | 77024694 | 126 | 689.90 € | 2 | 2637 |
| 75522003 | 237 | 4.00 € | 1 | 756 | 75999000 | 239 | 23.90 € | 1 | 756 | 77024698 | 126 | 899.90 € | 2 | 2637 |
| 75522004 | 237 | 4.00 € | 1 | 756 | 75999000 | 239 | 23.90 € | 1 | 756 | 77033073 | 126 | 389.90 € | 2 | 2637 |
| 75522027 | 237 | 4.00 € | 1 | 756 | 75999000 | 241 | 23.90 € | 1 | 756 | 77033074 | 126 | 409.90 € | 2 | 2637 |
| 75523003 | 238 | 2.70 € | 1 | 756 | 75999000 | 242 | 23.90 € | 1 | 756 | 77033078 | 126 | 609.90 € | 2 | 2637 |
| 75523004 | 238 | 2.70 € | 1 | 756 | 75999000 | 243 | 23.90 € | 1 | 756 | 77033083 | 126 | 389.90 € | 2 | 2637 |
| 75523027 | 238 | 2.70 € | 1 | 756 | 75999000 | 248 | 23.90 € | 1 | 756 | 77033084 | 126 | 409.90 € | 2 | 2637 |
| 75524003 | 239 | 2,45 € | 1 | 756 | 75999000 | 250 | 23.90 € | 1 | 756 | 77033088 | 126 | 609.90 € | 2 | 2637 |
| 75524004 | 239 | 2,45 € | 1 | 756 | 75999000 | 252 | 23.90 € | 1 | 756 | 77033693 | 126 | 389.90 € | 2 | 2637 |
| 75524027 | 239 | 2,45 € | 1 | 756 | 75999000 | 254 | 23.90 € | 1 | 756 | 77033694 | 126 | 409.90 € | 2 | 2637 |
| 75571003 | 236 | 5,65 € | 1 | 756 | 75999000 | 256 | 23.90 € | 1 | 756 | 77033698 | 126 | 599.90 € | 2 | 2637 |
| 75571004 | 236 | 5,65 € | 1 | 756 | 75999000 | 258 | 23.90 € | 1 | 756 | 77034073 | 126 | 659.90 € | 2 | 2637 |
| 75571027 | 236 | 5,65 € | 1 | 756 | 76581003 | 248 | 12.00 € | 1 | 680 | 77034074 | 126 | 659.90 € | 2 | 2637 |
| 75572003 | 237 | 5.10 € | 1 | 756 | 76581004 | 248 | 12.00 € | 1 | 680 | 77034078 | 126 | 869.90 € | 2 | 2637 |
| 75572004 | 237 | 5.10 € | 1 | 756 | 76581027 | 248 | 12.00 € | 1 | 680 | 77034083 | 126 | 659.90 € | 2 | 2637 |
| 75572027 | 237 | 5.10 € | 1 | 756 | 76582003 | 254 | 12.00 € | 1 | 680 | 77034084 | 126 | 659.90 € | 2 | 2637 |
| 75573003 | 238 | 3.60 € | 1 | 756 | 76582004 | 254 | 12.00 € | 1 | 680 | 77034088 | 126 | 869.90 € | 2 | 2637 |
| 75573004 | 238 | 3.60 € | 1 | 756 | 76582027 | 254 | 12.00 € | 1 | 680 | 77034693 | 126 | 659.90 € | 2 | 2637 |
| 75573027 | 238 | 3.60 € | 1 | 756 | 76591004 | 250 | 17.40 € | 1 | 680 | 77034694 | 126 | 659.90 € | 2 | 2637 |
| 75574003 | 239 | 3.30 € | 1 | 756 | 76592004 | 256 | 17.90 € | 1 | 680 | 77034698 | 126 | 869.90 € | 2 | 2637 |
| 75574004 | 239 | 3.30 € | 1 | 756 | 76601002 | 252 | 31.30 € | 1 | 680 | 77133073 | 127 | 369.90 € | 2 | 2637 |
| 75574027 | 239 | 3.30 € | 1 | 756 | 76602002 | 258 | 31.40 € | 1 | 680 | 77133074 | 127 | 369.90 € | 2 | 2637 |
| 75577002 | 243 | 9.70 € | 1 | 756 | 76999000 | 248 | 229.90 € | 1 | 756 | 77133078 | 127 | 589.90 € | 2 | 2637 |
| 75581003 | 248 | 12.00 € | 1 | 680 | 76999000 | 250 | 229.90 € | 1 | 756 | 77133083 | 127 | 369.90 € | 2 | 2637 |
| 75581004 | 248 | 12.00 € | 1 | 680 | 76999000 | 252 | 229.90 € | 1 | 756 | 77133084 | 127 | 369.90 € | 2 | 2637 |
| 75581027 | 248 | 12.00 € | 1 | 680 | 76999000 | 254 | 229.90 € | 1 | 756 | 77133088 | 127 | 589.90 € | 2 | 2637 |
| 75582003 | 254 | 12.00 € | 1 | 680 | 76999000 | 256 | 229.90 € | 1 | 756 | 77133693 | 127 | 369.90 € | 2 | 2637 |
| 75582004 | 254 | 12.00 € | 1 | 680 | 76999000 | 258 | 229.90 € | 1 | 756 | 77133694 | 127 | 369.90 € | 2 | 2637 |
| 75582027 | 254 | 12.00 € | 1 | 680 | 77023073 | 126 | 409.90 € | 2 | 2637 | 77133698 | 127 | 589.90 € | 2 | 2637 |
| 75591004 | 250 | 17.40 € | 1 | 680 | 77023074 | 126 | 409.90 € | 2 | 2637 | 77134073 | 127 | 529.90 € | 2 | 2637 |
| 75592004 | 256 | 17.90 € | 1 | 680 | 77023078 | 126 | 619.90 € | 2 | 2637 | 77134074 | 127 | 529.90 € | 2 | 2637 |
| 75601002 | 252 | 31.30 € | 1 | 680 | 77023083 | 126 | 409.90 € | 2 | 2637 | 77134078 | 127 | 749.90 € | 2 | 2637 |
| 75602002 | 258 | 31.40 € | 1 | 680 | 77023084 | 126 | 409.90 € | 2 | 2637 | 77134083 | 127 | 649.90 € | 2 | 2637 |
| 75998000 | 236 | 15.90 € | 1 | 756 | 77023088 | 126 | 619.90 € | 2 | 2637 | 77134084 | 127 | 649.90 € | 2 | 2637 |
| 75998000 | 238 | 15.90 € | 1 | 756 | 77023693 | 126 | 409.90 € | 2 | 2637 | 77134088 | 127 | 859.90 € | 2 | 2637 |
| 75998000 | 239 | 15.90 € | 1 | 756 | 77023694 | 126 | 409.90 € | 2 | 2637 | 77134693 | 127 | 649.90 € | 2 | 2637 |
| 75998000 | 241 | 15.90 € | 1 | 756 | 77023698 | 126 | 619.90 € | 2 | 2637 | 77134694 | 127 | 649.90 € | 2 | 2637 |

| Article no. | Page | Price in € | Discount group | Product group | Article no. | Page | Price in € | Discount group | Product group | Article no. | Page | Price in € | Discount group | Product group |
|-------------|------|------------|----------------|---------------|-------------|------|------------|----------------|---------------|-------------|------|------------|----------------|---------------|
| 77134698 | 127 | 859.90 € | 2 | 2637 | 77243694 | 128 | 469.90 € | 2 | 2637 | 77354693 | 129 | 939.90 € | 2 | 2637 |
| 77143073 | 127 | 359.90 € | 2 | 2637 | 77243698 | 128 | 649.90 € | 2 | 2637 | 77354694 | 129 | 939.90 € | 2 | 2637 |
| 77143074 | 127 | 359.90 € | 2 | 2637 | 77244073 | 128 | 639.90 € | 2 | 2637 | 77354698 | 129 | 1,269.90 € | 2 | 2637 |
| 77143078 | 127 | 579.90 € | 2 | 2637 | 77244074 | 128 | 639.90 € | 2 | 2637 | 77411174AI | 87 | 2,049.00 € | 2 | 2944 |
| 77143083 | 127 | 359.90 € | 2 | 2637 | 77244078 | 128 | 859.90 € | 2 | 2637 | 77411174MS | 87 | 1,829.00 € | 2 | 2944 |
| 77143084 | 127 | 359.90 € | 2 | 2637 | 77244083 | 128 | 739.90 € | 2 | 2637 | 77411174ST | 87 | 1,949.00 € | 2 | 2944 |
| 77143088 | 127 | 579.90 € | 2 | 2637 | 77244084 | 128 | 739.90 € | 2 | 2637 | 77411184AI | 87 | 2,049.00 € | 2 | 2944 |
| 77143693 | 127 | 359.90 € | 2 | 2637 | 77244088 | 128 | 949.90 € | 2 | 2637 | 77411184MS | 87 | 1,829.00 € | 2 | 2944 |
| 77143694 | 127 | 359.90 € | 2 | 2637 | 77244693 | 128 | 739.90 € | 2 | 2637 | 77411184ST | 87 | 1,949.00 € | 2 | 2944 |
| 77143698 | 127 | 579.90 € | 2 | 2637 | 77244694 | 128 | 739.90 € | 2 | 2637 | 77411694AI | 87 | 2,049.00 € | 2 | 2944 |
| 77144073 | 127 | 579.90 € | 2 | 2637 | 77244698 | 128 | 949.90 € | 2 | 2637 | 77411694MS | 87 | 1,829.00 € | 2 | 2944 |
| 77144074 | 127 | 579.90 € | 2 | 2637 | 77333073 | 129 | 589.90 € | 2 | 2637 | 77411694ST | 87 | 1,949.00 € | 2 | 2944 |
| 77144078 | 127 | 799.90 € | 2 | 2637 | 77333074 | 129 | 589.90 € | 2 | 2637 | 77412174AI | 89 | 3,439.00 € | 2 | 2944 |
| 77144083 | 127 | 619.90 € | 2 | 2637 | 77333078 | 129 | 759.90 € | 2 | 2637 | 77412174MS | 89 | 2,999.00 € | 2 | 2944 |
| 77144084 | 127 | 619.90 € | 2 | 2637 | 77333083 | 129 | 589.90 € | 2 | 2637 | 77412174ST | 89 | 3,249.00 € | 2 | 2944 |
| 77144088 | 127 | 839.90 € | 2 | 2637 | 77333084 | 129 | 589.90 € | 2 | 2637 | 77412184AI | 89 | 3,439.00 € | 2 | 2944 |
| 77144693 | 127 | 619.90 € | 2 | 2637 | 77333088 | 129 | 759.90 € | 2 | 2637 | 77412184MS | 89 | 2,999.00 € | 2 | 2944 |
| 77144694 | 127 | 619.90 € | 2 | 2637 | 77333693 | 129 | 589.90 € | 2 | 2637 | 77412184ST | 89 | 3,249.00 € | 2 | 2944 |
| 77144698 | 127 | 839.90 € | 2 | 2637 | 77333694 | 129 | 589.90 € | 2 | 2637 | 77412694AI | 89 | 3,439.00 € | 2 | 2944 |
| 77233073 | 128 | 619.90 € | 2 | 2637 | 77333698 | 129 | 759.90 € | 2 | 2637 | 77412694MS | 89 | 2,999.00 € | 2 | 2944 |
| 77233074 | 128 | 619.90 € | 2 | 2637 | 77334073 | 129 | 969.90 € | 2 | 2637 | 77412694ST | 89 | 3,249.00 € | 2 | 2944 |
| 77233078 | 128 | 799.90 € | 2 | 2637 | 77334074 | 129 | 969.90 € | 2 | 2637 | 77413174AI | 91 | 4,769.00 € | 2 | 2944 |
| 77233083 | 128 | 489.90 € | 2 | 2637 | 77334078 | 129 | 1,299.90 € | 2 | 2637 | 77413174MS | 91 | 4,099.00 € | 2 | 2944 |
| 77233084 | 128 | 489.90 € | 2 | 2637 | 77334083 | 129 | 969.90 € | 2 | 2637 | 77413174ST | 91 | 4,479.00 € | 2 | 2944 |
| 77233088 | 128 | 659.90 € | 2 | 2637 | 77334084 | 129 | 969.90 € | 2 | 2637 | 77413184AI | 91 | 4,769.00 € | 2 | 2944 |
| 77233693 | 128 | 489.90 € | 2 | 2637 | 77334088 | 129 | 1,299.90 € | 2 | 2637 | 77413184MS | 91 | 4,099.00 € | 2 | 2944 |
| 77233694 | 128 | 489.90 € | 2 | 2637 | 77334693 | 129 | 969.90 € | 2 | 2637 | 77413184ST | 91 | 4,479.00 € | 2 | 2944 |
| 77233698 | 128 | 659.90 € | 2 | 2637 | 77334694 | 129 | 969.90 € | 2 | 2637 | 77413694AI | 91 | 4,769.00 € | 2 | 2944 |
| 77234073 | 128 | 639.90 € | 2 | 2637 | 77334698 | 129 | 1,299.90 € | 2 | 2637 | 77413694MS | 91 | 4,099.00 € | 2 | 2944 |
| 77234074 | 128 | 639.90 € | 2 | 2637 | 77353073 | 129 | 579.90 € | 2 | 2637 | 77413694ST | 91 | 4,479.00 € | 2 | 2944 |
| 77234078 | 128 | 979.90 € | 2 | 2637 | 77353074 | 129 | 579.90 € | 2 | 2637 | 77414174AI | 93 | 6,099.00 € | 2 | 2944 |
| 77234083 | 128 | 759.90 € | 2 | 2637 | 77353078 | 129 | 749.90 € | 2 | 2637 | 77414174MS | 93 | 5,199.00 € | 2 | 2944 |
| 77234084 | 128 | 759.90 € | 2 | 2637 | 77353083 | 129 | 579.90 € | 2 | 2637 | 77414174ST | 93 | 5,699.00 € | 2 | 2944 |
| 77234088 | 128 | 979.90 € | 2 | 2637 | 77353084 | 129 | 579.90 € | 2 | 2637 | 77414184AI | 93 | 6,099.00 € | 2 | 2944 |
| 77234693 | 128 | 759.90 € | 2 | 2637 | 77353088 | 129 | 749.90 € | 2 | 2637 | 77414184MS | 93 | 5,199.00 € | 2 | 2944 |
| 77234694 | 128 | 759.90 € | 2 | 2637 | 77353693 | 129 | 579.90 € | 2 | 2637 | 77414184ST | 93 | 5,699.00 € | 2 | 2944 |
| 77234698 | 128 | 979.90 € | 2 | 2637 | 77353694 | 129 | 579.90 € | 2 | 2637 | 77414694AI | 93 | 6,099.00 € | 2 | 2944 |
| 77243073 | 128 | 619.90 € | 2 | 2637 | 77353698 | 129 | 749.90 € | 2 | 2637 | 77414694MS | 93 | 5,199.00 € | 2 | 2944 |
| 77243074 | 128 | 619.90 € | 2 | 2637 | 77354073 | 129 | 939.90 € | 2 | 2637 | 77414694ST | 93 | 5,699.00 € | 2 | 2944 |
| 77243078 | 128 | 839.90 € | 2 | 2637 | 77354074 | 129 | 939.90 € | 2 | 2637 | 77422174AI | 89 | 3,439.00 € | 2 | 2944 |
| 77243083 | 128 | 469.90 € | 2 | 2637 | 77354078 | 129 | 1,269.90 € | 2 | 2637 | 77422174MS | 89 | 2,999.00 € | 2 | 2944 |
| 77243084 | 128 | 469.90 € | 2 | 2637 | 77354083 | 129 | 939.90 € | 2 | 2637 | 77422174ST | 89 | 3,249.00 € | 2 | 2944 |
| 77243088 | 128 | 649.90 € | 2 | 2637 | 77354084 | 129 | 939.90 € | 2 | 2637 | 77422184AI | 89 | 3,439.00 € | 2 | 2944 |
| 77243693 | 128 | 469.90 € | 2 | 2637 | 77354088 | 129 | 1,269.90 € | 2 | 2637 | 77422184MS | 89 | 2,999.00 € | 2 | 2944 |

| Article no. | Page | Price in € | Discount group | Product group | Article no. | Page | Price in € | Discount group | Product group | Article no. | Page | Price in € | Discount group | Product group |
|-------------|------|------------|----------------|---------------|-------------|------|------------|----------------|---------------|-------------|------|------------|----------------|---------------|
| 77422184ST | 89 | 3,249.00 € | 2 | 2944 | 78310084 | 220 | 274.90 € | 2 | 2869 | 81032072 | 13 | 56.50 € | 2 | 2941 |
| 77422694AI | 89 | 3,439.00 € | 2 | 2944 | 78311084 | 220 | 307.90 € | 2 | 2869 | 81045250 | 221 | 32.90 € | 2 | 2869 |
| 77422694MS | 89 | 2,999.00 € | 2 | 2944 | 78312084 | 220 | 351.90 € | 2 | 2869 | 81046250 | 221 | 38.40 € | 2 | 2869 |
| 77422694ST | 89 | 3,249.00 € | 2 | 2944 | 78313084 | 219 | 369.90 € | 2 | 2869 | 81048000 | 221 | 79.10 € | 2 | 2869 |
| 77423174AI | 91 | 4,769.00 € | 2 | 2944 | 78912114 | 215 | 279.90 € | 2 | 2869 | 81049080 | 221 | 32.90 € | 2 | 2869 |
| 77423174MS | 91 | 4,099.00 € | 2 | 2944 | 78913114 | 215 | 299.90 € | 2 | 2869 | 81050000 | 221 | 20.80 € | 2 | 2869 |
| 77423174ST | 91 | 4,479.00 € | 2 | 2944 | 79030004 | 223 | 174.90 € | 2 | 2869 | 81051000 | 221 | 10.90 € | 2 | 2869 |
| 77423184AI | 91 | 4,769.00 € | 2 | 2944 | 79031004 | 223 | 163.90 € | 2 | 2869 | 81052000 | 221 | 21.80 € | 2 | 2869 |
| 77423184MS | 91 | 4,099.00 € | 2 | 2944 | 79130004 | 223 | 152.90 € | 2 | 2869 | 81053000 | 221 | 32.70 € | 2 | 2869 |
| 77423184ST | 91 | 4,479.00 € | 2 | 2944 | 79230264 | 224 | 251.90 € | 2 | 2869 | 81055000 | 221 | 54.50 € | 2 | 2869 |
| 77423694AI | 91 | 4,769.00 € | 2 | 2944 | 79231264 | 224 | 207.90 € | 2 | 2869 | 81057000 | 221 | 13.10 € | 2 | 2869 |
| 77423694MS | 91 | 4,099.00 € | 2 | 2944 | 81011060 | 215 | 4.20 € | 2 | 2869 | 81058000 | 221 | 14.20 € | 2 | 2869 |
| 77423694ST | 91 | 4,479.00 € | 2 | 2944 | 81011120 | 215 | 5.90 € | 2 | 2869 | 81060000 | 221 | 13.10 € | 2 | 2869 |
| 77432174AI | 89 | 3,439.00 € | 2 | 2944 | 81011150 | 215 | 7.60 € | 2 | 2869 | 81062000 | 221 | 13.10 € | 2 | 2869 |
| 77432174MS | 89 | 2,999.00 € | 2 | 2944 | 81017000 | 403 | 7.60 € | 1 | 675 | 81078030 | 215 | 229.90 € | 2 | 2869 |
| 77432174ST | 89 | 3,249.00 € | 2 | 2944 | 81020502 | 175 | 16.70 € | 1 | 675 | 81090000 | 221 | 13.10 € | 2 | 2869 |
| 77432184AI | 89 | 3,439.00 € | 2 | 2944 | 81020508 | 175 | 16.70 € | 1 | 675 | 81092000 | 221 | 13.10 € | 2 | 2869 |
| 77432184MS | 89 | 2,999.00 € | 2 | 2944 | 81020515 | 175 | 16.70 € | 1 | 675 | 81100640 | 217 | 120.90 € | 2 | 2869 |
| 77432184ST | 89 | 3,249.00 € | 2 | 2944 | 81020602 | 175 | 19.20 € | 1 | 675 | 81100640 | 437 | 120.90 € | 2 | 2869 |
| 77432694AI | 89 | 3,439.00 € | 2 | 2944 | 81020608 | 175 | 19.20 € | 1 | 675 | 81101640 | 217 | 120.90 € | 2 | 2869 |
| 77432694MS | 89 | 2,999.00 € | 2 | 2944 | 81020615 | 175 | 19.20 € | 1 | 675 | 81101640 | 437 | 120.90 € | 2 | 2869 |
| 77432694ST | 89 | 3,249.00 € | 2 | 2944 | 81020702 | 175 | 25.70 € | 1 | 675 | 81102640 | 217 | 120.90 € | 2 | 2869 |
| 77442174AI | 89 | 3,439.00 € | 2 | 2944 | 81020708 | 175 | 25.70 € | 1 | 675 | 81102640 | 437 | 120.90 € | 2 | 2869 |
| 77442174MS | 89 | 2,999.00 € | 2 | 2944 | 81020715 | 175 | 25.70 € | 1 | 675 | 81106000 | 249 | 89.90 € | 1 | 66 |
| 77442174ST | 89 | 3,249.00 € | 2 | 2944 | 81021000 | 403 | 12.80 € | 1 | 675 | 81106000 | 251 | 89.90 € | 1 | 66 |
| 77442184AI | 89 | 3,439.00 € | 2 | 2944 | 81022000 | 403 | 76.90 € | 1 | 675 | 81106000 | 253 | 89.90 € | 1 | 66 |
| 77442184MS | 89 | 2,999.00 € | 2 | 2944 | 81023000 | 403 | 28.50 € | 1 | 675 | 81106000 | 255 | 89.90 € | 1 | 66 |
| 77442184ST | 89 | 3,249.00 € | 2 | 2944 | 81026160 | 34 | 47.10 € | 1 | 675 | 81106000 | 257 | 89.90 € | 1 | 66 |
| 77442694AI | 89 | 3,439.00 € | 2 | 2944 | 81026160 | 35 | 47.10 € | 1 | 675 | 81106000 | 259 | 89.90 € | 1 | 66 |
| 77442694MS | 89 | 2,999.00 € | 2 | 2944 | 81026170 | 34 | 47.10 € | 1 | 675 | 81120640 | 217 | 36.90 € | 2 | 2869 |
| 77442694ST | 89 | 3,249.00 € | 2 | 2944 | 81026170 | 35 | 47.10 € | 1 | 675 | 81120640 | 437 | 36.90 € | 2 | 2869 |
| 77450694 | 97 | 829.90 € | 2 | 2971 | 81026180 | 34 | 47.10 € | 1 | 675 | 81121640 | 217 | 36.90 € | 2 | 2869 |
| 77451694 | 98 | 1,299.90 € | 2 | 2637 | 81026180 | 35 | 47.10 € | 1 | 675 | 81121640 | 437 | 36.90 € | 2 | 2869 |
| 77452694 | 97 | 1,599.90 € | 2 | 2637 | 81032050 | 13 | 43.00 € | 2 | 2941 | 81122640 | 217 | 36.90 € | 2 | 2869 |
| 77453694 | 99 | 1,659.00 € | 2 | 2637 | 81032051 | 13 | 39.00 € | 2 | 2941 | 81122640 | 437 | 36.90 € | 2 | 2869 |
| 77454694 | 96 | 629.90 € | 2 | 2637 | 81032055 | 13 | 43.00 € | 2 | 2941 | 81123160 | 28 | 26.20 € | 1 | 675 |
| 78011114 | 214 | 39.90 € | 2 | 2869 | 81032056 | 13 | 39.00 € | 2 | 2941 | 81123160 | 29 | 26.20 € | 1 | 675 |
| 78012114 | 214 | 49.90 € | 2 | 2869 | 81032063 | 13 | 47.50 € | 2 | 2941 | 81123170 | 28 | 26.20 € | 1 | 675 |
| 78013114 | 214 | 59.90 € | 2 | 2869 | 81032064 | 13 | 45.00 € | 2 | 2941 | 81123170 | 29 | 26.20 € | 1 | 675 |
| 78014114 | 214 | 59.90 € | 2 | 2869 | 81032066 | 13 | 58.00 € | 2 | 2941 | 81123180 | 28 | 26.20 € | 1 | 675 |
| 78015114 | 214 | 69.90 € | 2 | 2869 | 81032067 | 13 | 55.50 € | 2 | 2941 | 81123180 | 29 | 26.20 € | 1 | 675 |
| 78111114 | 213 | 79.90 € | 2 | 2869 | 81032068 | 13 | 15.00 € | 2 | 2637 | 81124160 | 30 | 33.10 € | 1 | 675 |
| 78114114 | 213 | 89.90 € | 2 | 2869 | 81032069 | 13 | 15.00 € | 2 | 2637 | 81124160 | 31 | 33.10 € | 1 | 675 |
| 78115114 | 213 | 99.90 € | 2 | 2869 | 81032071 | 13 | 59.00 € | 2 | 2941 | 81124170 | 30 | 33.10 € | 1 | 675 |

| Article no. | Page | Price in € | Discount group | Product group | Article no. | Page | Price in € | Discount group | Product group | Article no. | Page | Price in € | Discount group | Product group |
|-------------|------|------------|----------------|---------------|-------------|------|------------|----------------|---------------|-------------|------|------------|----------------|---------------|
| 81124170 | 31 | 33.10 € | 1 | 675 | 81146180 | 35 | 50.60 € | 1 | 675 | 84010173MT | 111 | 2,099.90 € | 2 | 2637 |
| 81124180 | 30 | 33.10 € | 1 | 675 | 81147160 | 36 | 57.50 € | 1 | 675 | 84010174 | 111 | 1,949.90 € | 2 | 2637 |
| 81124180 | 31 | 33.10 € | 1 | 675 | 81147160 | 37 | 57.50 € | 1 | 675 | 84010174CA | 111 | 2,099.90 € | 2 | 2637 |
| 81125160 | 32 | 40.10 € | 1 | 675 | 81147170 | 36 | 57.50 € | 1 | 675 | 84010174MT | 111 | 2,099.90 € | 2 | 2637 |
| 81125160 | 33 | 40.10 € | 1 | 675 | 81147170 | 37 | 57.50 € | 1 | 675 | 84010183 | 111 | 1,949.90 € | 2 | 2637 |
| 81125170 | 32 | 40.10 € | 1 | 675 | 81147180 | 36 | 57.50 € | 1 | 675 | 84010183CA | 111 | 2,099.90 € | 2 | 2637 |
| 81125170 | 33 | 40.10 € | 1 | 675 | 81147180 | 37 | 57.50 € | 1 | 675 | 84010183MT | 111 | 2,099.90 € | 2 | 2637 |
| 81125180 | 32 | 40.10 € | 1 | 675 | 81210080 | 47 | 3.20 € | 1 | 675 | 84010184 | 111 | 1,949.90 € | 2 | 2637 |
| 81125180 | 33 | 40.10 € | 1 | 675 | 81211080 | 47 | 4.80 € | 1 | 675 | 84010184CA | 111 | 2,099.90 € | 2 | 2637 |
| 81127160 | 36 | 54.00 € | 1 | 675 | 81212080 | 47 | 5.40 € | 1 | 675 | 84010184MT | 111 | 2,099.90 € | 2 | 2637 |
| 81127160 | 37 | 54.00 € | 1 | 675 | 81213080 | 47 | 7.20 € | 1 | 675 | 84012173 | 111 | 2,499.90 € | 2 | 2637 |
| 81127170 | 36 | 54.00 € | 1 | 675 | 81214080 | 47 | 8.00 € | 1 | 675 | 84012173CA | 111 | 2,699.90 € | 2 | 2637 |
| 81127170 | 37 | 54.00 € | 1 | 675 | 81215070 | 47 | 3.60 € | 1 | 675 | 84012173MT | 111 | 2,699.90 € | 2 | 2637 |
| 81127180 | 36 | 54.00 € | 1 | 675 | 81215080 | 47 | 3.60 € | 1 | 675 | 84012174 | 111 | 2,499.90 € | 2 | 2637 |
| 81127180 | 37 | 54.00 € | 1 | 675 | 81216070 | 47 | 6.40 € | 1 | 675 | 84012174CA | 111 | 2,699.90 € | 2 | 2637 |
| 81128090 | 329 | 5.90 € | 1 | 693 | 81216080 | 47 | 6.40 € | 1 | 675 | 84012174MT | 111 | 2,699.90 € | 2 | 2637 |
| 81128170 | 329 | 5.90 € | 1 | 693 | 81217070 | 47 | 8.00 € | 1 | 675 | 84012183 | 111 | 2,499.90 € | 2 | 2637 |
| 81128690 | 329 | 5.90 € | 1 | 693 | 81217080 | 47 | 8.00 € | 1 | 675 | 84012183CA | 111 | 2,699.90 € | 2 | 2637 |
| 81129090 | 329 | 7.90 € | 1 | 693 | 81218070 | 47 | 9.60 € | 1 | 675 | 84012183MT | 111 | 2,699.90 € | 2 | 2637 |
| 81129170 | 329 | 7.90 € | 1 | 693 | 81218080 | 47 | 9.60 € | 1 | 675 | 84012184 | 111 | 2,499.90 € | 2 | 2637 |
| 81129690 | 329 | 7.90 € | 1 | 693 | 81219070 | 47 | 11.20 € | 1 | 675 | 84012184CA | 111 | 2,699.90 € | 2 | 2637 |
| 81143160 | 28 | 29.70 € | 1 | 675 | 81219080 | 47 | 11.20 € | 1 | 675 | 84012184MT | 111 | 2,699.90 € | 2 | 2637 |
| 81143160 | 29 | 29.70 € | 1 | 675 | 81220070 | 47 | 14.80 € | 1 | 675 | 84014173 | 111 | 3,849.90 € | 2 | 2637 |
| 81143170 | 28 | 29.70 € | 1 | 675 | 81220080 | 47 | 14.80 € | 1 | 675 | 84014173CA | 111 | 3,999.90 € | 2 | 2637 |
| 81143170 | 29 | 29.70 € | 1 | 675 | 81221070 | 47 | 18.80 € | 1 | 675 | 84014173MT | 111 | 3,999.90 € | 2 | 2637 |
| 81143180 | 28 | 29.70 € | 1 | 675 | 81221080 | 47 | 18.80 € | 1 | 675 | 84014174 | 111 | 3,849.90 € | 2 | 2637 |
| 81143180 | 29 | 29.70 € | 1 | 675 | 81222070 | 47 | 20.80 € | 1 | 675 | 84014174CA | 111 | 3,999.90 € | 2 | 2637 |
| 81144160 | 30 | 36.60 € | 1 | 675 | 81222080 | 47 | 20.80 € | 1 | 675 | 84014174MT | 111 | 3,999.90 € | 2 | 2637 |
| 81144160 | 31 | 36.60 € | 1 | 675 | 81223070 | 47 | 24.80 € | 1 | 675 | 84014183 | 111 | 3,849.90 € | 2 | 2637 |
| 81144170 | 30 | 36.60 € | 1 | 675 | 81223080 | 47 | 24.80 € | 1 | 675 | 84014183CA | 111 | 3,999.90 € | 2 | 2637 |
| 81144170 | 31 | 36.60 € | 1 | 675 | 81224070 | 47 | 28.80 € | 1 | 675 | 84014183MT | 111 | 3,999.90 € | 2 | 2637 |
| 81144180 | 30 | 36.60 € | 1 | 675 | 81224080 | 47 | 28.80 € | 1 | 675 | 84014184 | 111 | 3,849.90 € | 2 | 2637 |
| 81144180 | 31 | 36.60 € | 1 | 675 | 81230070 | 47 | 31.20 € | 1 | 675 | 84014184CA | 111 | 3,999.90 € | 2 | 2637 |
| 81145160 | 32 | 43.60 € | 1 | 675 | 81230080 | 47 | 31.20 € | 1 | 675 | 84014184MT | 111 | 3,999.90 € | 2 | 2637 |
| 81145160 | 33 | 43.60 € | 1 | 675 | 81231070 | 47 | 39.70 € | 1 | 675 | 84030173 | 103 | 999.90 € | 2 | 2637 |
| 81145170 | 32 | 43.60 € | 1 | 675 | 81231080 | 47 | 39.70 € | 1 | 675 | 84030173CA | 103 | 1,299.90 € | 2 | 2637 |
| 81145170 | 33 | 43.60 € | 1 | 675 | 81401120 | 339 | 29.90 € | 1 | 675 | 84030173MT | 103 | 1,299.90 € | 2 | 2637 |
| 81145180 | 32 | 43.60 € | 1 | 675 | 81401120 | 415 | 29.90 € | 1 | 675 | 84030174 | 103 | 999.90 € | 2 | 2637 |
| 81145180 | 33 | 43.60 € | 1 | 675 | 81401730 | 339 | 39.90 € | 1 | 675 | 84030174CA | 103 | 1,299.90 € | 2 | 2637 |
| 81146160 | 34 | 50.60 € | 1 | 675 | 81401730 | 415 | 39.90 € | 1 | 675 | 84030174MT | 103 | 1,299.90 € | 2 | 2637 |
| 81146160 | 35 | 50.60 € | 1 | 675 | 81440180 | 415 | 199.90 € | 1 | 693 | 84030183 | 103 | 999.90 € | 2 | 2637 |
| 81146170 | 34 | 50.60 € | 1 | 675 | 81475180 | 415 | 249.90 € | 1 | 693 | 84030183CA | 103 | 1,299.90 € | 2 | 2637 |
| 81146170 | 35 | 50.60 € | 1 | 675 | 84010173 | 111 | 1,949.90 € | 2 | 2637 | 84030183MT | 103 | 1,299.90 € | 2 | 2637 |
| 81146180 | 34 | 50.60 € | 1 | 675 | 84010173CA | 111 | 2,099.90 € | 2 | 2637 | 84030184 | 103 | 999.90 € | 2 | 2637 |

| Article no. | Page | Price in € | Discount group | Product group | Article no. | Page | Price in € | Discount group | Product group | Article no. | Page | Price in € | Discount group | Product group |
|-------------|------|------------|----------------|---------------|-------------|------|------------|----------------|---------------|-------------|------|------------|----------------|---------------|
| 84030184CA | 103 | 1,299.90 € | 2 | 2637 | 84074183 | 105 | 2,099.90 € | 2 | 2637 | 88184175 | 77 | 129.90 € | 1 | 695 |
| 84030184MT | 103 | 1,299.90 € | 2 | 2637 | 84074183CA | 105 | 2,399.90 € | 2 | 2637 | 88184183 | 77 | 129.90 € | 1 | 695 |
| 84032173 | 103 | 1,399.90 € | 2 | 2637 | 84074183MT | 105 | 2,399.90 € | 2 | 2637 | 88184184 | 77 | 129.90 € | 1 | 695 |
| 84032173CA | 103 | 1,699.90 € | 2 | 2637 | 84074184 | 105 | 2,099.90 € | 2 | 2637 | 88184185 | 77 | 129.90 € | 1 | 695 |
| 84032173MT | 103 | 1,699.90 € | 2 | 2637 | 84074184CA | 105 | 2,399.90 € | 2 | 2637 | 88242163 | 72 | 109.90 € | 1 | 695 |
| 84032174 | 103 | 1,399.90 € | 2 | 2637 | 84074184MT | 105 | 2,399.90 € | 2 | 2637 | 88242164 | 72 | 109.90 € | 1 | 695 |
| 84032174CA | 103 | 1,699.90 € | 2 | 2637 | 84110173 | 107 | 2,099.90 € | 2 | 2637 | 88242165 | 72 | 109.90 € | 1 | 695 |
| 84032174MT | 103 | 1,699.90 € | 2 | 2637 | 84110173CA | 107 | 2,399.90 € | 2 | 2637 | 88242173 | 72 | 109.90 € | 1 | 695 |
| 84034173 | 103 | 2,099.90 € | 2 | 2637 | 84110173MT | 107 | 2,399.90 € | 2 | 2637 | 88242174 | 72 | 109.90 € | 1 | 695 |
| 84034173CA | 103 | 2,399.90 € | 2 | 2637 | 84110174 | 107 | 2,099.90 € | 2 | 2637 | 88242175 | 72 | 109.90 € | 1 | 695 |
| 84034173MT | 103 | 2,399.90 € | 2 | 2637 | 84110174CA | 107 | 2,399.90 € | 2 | 2637 | 88242183 | 72 | 109.90 € | 1 | 695 |
| 84034174 | 103 | 2,099.90 € | 2 | 2637 | 84110174MT | 107 | 2,399.90 € | 2 | 2637 | 88242184 | 72 | 109.90 € | 1 | 695 |
| 84034174CA | 103 | 2,399.90 € | 2 | 2637 | 84110183 | 107 | 2,099.90 € | 2 | 2637 | 88242185 | 72 | 109.90 € | 1 | 695 |
| 84034174MT | 103 | 2,399.90 € | 2 | 2637 | 84110183CA | 107 | 2,399.90 € | 2 | 2637 | 88244163 | 72 | 109.90 € | 1 | 695 |
| 84070173 | 105 | 999.90 € | 2 | 2637 | 84110183MT | 107 | 2,399.90 € | 2 | 2637 | 88244164 | 72 | 109.90 € | 1 | 695 |
| 84070173CA | 105 | 1,299.90 € | 2 | 2637 | 84110184 | 107 | 2,099.90 € | 2 | 2637 | 88244165 | 72 | 109.90 € | 1 | 695 |
| 84070173MT | 105 | 1,299.90 € | 2 | 2637 | 84110184CA | 107 | 2,399.90 € | 2 | 2637 | 88244173 | 72 | 109.90 € | 1 | 695 |
| 84070174 | 105 | 999.90 € | 2 | 2637 | 84110184MT | 107 | 2,399.90 € | 2 | 2637 | 88244174 | 72 | 109.90 € | 1 | 695 |
| 84070174CA | 105 | 1,299.90 € | 2 | 2637 | 84112173 | 107 | 2,699.90 € | 2 | 2637 | 88244175 | 72 | 109.90 € | 1 | 695 |
| 84070174MT | 105 | 1,299.90 € | 2 | 2637 | 84112173CA | 107 | 2,999.90 € | 2 | 2637 | 88244183 | 72 | 109.90 € | 1 | 695 |
| 84070183 | 105 | 999.90 € | 2 | 2637 | 84112173MT | 107 | 2,999.90 € | 2 | 2637 | 88244184 | 72 | 109.90 € | 1 | 695 |
| 84070183CA | 105 | 1,299.90 € | 2 | 2637 | 84112174 | 107 | 2,699.90 € | 2 | 2637 | 88244185 | 72 | 109.90 € | 1 | 695 |
| 84070183MT | 105 | 1,299.90 € | 2 | 2637 | 84112174CA | 107 | 2,999.90 € | 2 | 2637 | 88246163 | 72 | 109.90 € | 1 | 695 |
| 84070184 | 105 | 999.90 € | 2 | 2637 | 84112174MT | 107 | 2,999.90 € | 2 | 2637 | 88246164 | 72 | 109.90 € | 1 | 695 |
| 84070184CA | 105 | 1,299.90 € | 2 | 2637 | 84112183 | 107 | 2,699.90 € | 2 | 2637 | 88246165 | 72 | 109.90 € | 1 | 695 |
| 84070184MT | 105 | 1,299.90 € | 2 | 2637 | 84112183CA | 107 | 2,999.90 € | 2 | 2637 | 88246173 | 72 | 109.90 € | 1 | 695 |
| 84072173 | 105 | 1,399.90 € | 2 | 2637 | 84112183MT | 107 | 2,999.90 € | 2 | 2637 | 88246174 | 72 | 109.90 € | 1 | 695 |
| 84072173CA | 105 | 1,699.90 € | 2 | 2637 | 84112184 | 107 | 2,699.90 € | 2 | 2637 | 88246175 | 72 | 109.90 € | 1 | 695 |
| 84072173MT | 105 | 1,699.90 € | 2 | 2637 | 84112184CA | 107 | 2,999.90 € | 2 | 2637 | 88246183 | 72 | 109.90 € | 1 | 695 |
| 84072174 | 105 | 1,399.90 € | 2 | 2637 | 84112184MT | 107 | 2,999.90 € | 2 | 2637 | 88246184 | 72 | 109.90 € | 1 | 695 |
| 84072174CA | 105 | 1,699.90 € | 2 | 2637 | 84114173 | 107 | 3,699.90 € | 2 | 2637 | 88246185 | 72 | 109.90 € | 1 | 695 |
| 84072174MT | 105 | 1,699.90 € | 2 | 2637 | 84114173CA | 107 | 3,999.90 € | 2 | 2637 | 88252163 | 73 | 129.90 € | 1 | 695 |
| 84072183 | 105 | 1,399.90 € | 2 | 2637 | 84114173MT | 107 | 3,999.90 € | 2 | 2637 | 88252164 | 73 | 129.90 € | 1 | 695 |
| 84072183CA | 105 | 1,699.90 € | 2 | 2637 | 84114174 | 107 | 3,699.90 € | 2 | 2637 | 88252165 | 73 | 129.90 € | 1 | 695 |
| 84072183MT | 105 | 1,699.90 € | 2 | 2637 | 84114174CA | 107 | 3,999.90 € | 2 | 2637 | 88252173 | 73 | 129.90 € | 1 | 695 |
| 84072184 | 105 | 1,399.90 € | 2 | 2637 | 84114174MT | 107 | 3,999.90 € | 2 | 2637 | 88252174 | 73 | 129.90 € | 1 | 695 |
| 84072184CA | 105 | 1,699.90 € | 2 | 2637 | 84114183 | 107 | 3,699.90 € | 2 | 2637 | 88252175 | 73 | 129.90 € | 1 | 695 |
| 84072184MT | 105 | 1,699.90 € | 2 | 2637 | 84114183CA | 107 | 3,999.90 € | 2 | 2637 | 88252183 | 73 | 129.90 € | 1 | 695 |
| 84074173 | 105 | 2,099.90 € | 2 | 2637 | 84114183MT | 107 | 3,999.90 € | 2 | 2637 | 88252184 | 73 | 129.90 € | 1 | 695 |
| 84074173CA | 105 | 2,399.90 € | 2 | 2637 | 84114184 | 107 | 3,699.90 € | 2 | 2637 | 88252185 | 73 | 129.90 € | 1 | 695 |
| 84074173MT | 105 | 2,399.90 € | 2 | 2637 | 84114184CA | 107 | 3,999.90 € | 2 | 2637 | 88253163 | 73 | 129.90 € | 1 | 695 |
| 84074174 | 105 | 2,099.90 € | 2 | 2637 | 84114184MT | 107 | 3,999.90 € | 2 | 2637 | 88253164 | 73 | 129.90 € | 1 | 695 |
| 84074174CA | 105 | 2,399.90 € | 2 | 2637 | 88184173 | 77 | 129.90 € | 1 | 695 | 88253165 | 73 | 129.90 € | 1 | 695 |
| 84074174MT | 105 | 2,399.90 € | 2 | 2637 | 88184174 | 77 | 129.90 € | 1 | 695 | 88253173 | 73 | 129.90 € | 1 | 695 |

| Article no. | Page | Price in € | Discount group | Product group | Article no. | Page | Price in € | Discount group | Product group | Article no. | Page | Price in € | Discount group | Product group |
|-------------|------|------------|----------------|---------------|-------------|------|------------|----------------|---------------|-------------|------|------------|----------------|---------------|
| 88253174 | 73 | 129.90 € | 1 | 695 | 88266173 | 74 | 149.90 € | 1 | 695 | 88276165 | 75 | 169.90 € | 1 | 695 |
| 88253175 | 73 | 129.90 € | 1 | 695 | 88266174 | 74 | 149.90 € | 1 | 695 | 88276173 | 75 | 169.90 € | 1 | 695 |
| 88253183 | 73 | 129.90 € | 1 | 695 | 88266175 | 74 | 149.90 € | 1 | 695 | 88276174 | 75 | 169.90 € | 1 | 695 |
| 88253184 | 73 | 129.90 € | 1 | 695 | 88266183 | 74 | 149.90 € | 1 | 695 | 88276175 | 75 | 169.90 € | 1 | 695 |
| 88253185 | 73 | 129.90 € | 1 | 695 | 88266184 | 74 | 149.90 € | 1 | 695 | 88276183 | 75 | 169.90 € | 1 | 695 |
| 88254163 | 73 | 129.90 € | 1 | 695 | 88266185 | 74 | 149.90 € | 1 | 695 | 88276184 | 75 | 169.90 € | 1 | 695 |
| 88254164 | 73 | 129.90 € | 1 | 695 | 88271163 | 75 | 169.90 € | 1 | 695 | 88276185 | 75 | 169.90 € | 1 | 695 |
| 88254165 | 73 | 129.90 € | 1 | 695 | 88271164 | 75 | 169.90 € | 1 | 695 | 88693163 | 50 | 119.90 € | 1 | 695 |
| 88254173 | 73 | 129.90 € | 1 | 695 | 88271165 | 75 | 169.90 € | 1 | 695 | 88693164 | 50 | 119.90 € | 1 | 695 |
| 88254174 | 73 | 129.90 € | 1 | 695 | 88271173 | 75 | 169.90 € | 1 | 695 | 88693165 | 50 | 119.90 € | 1 | 695 |
| 88254175 | 73 | 129.90 € | 1 | 695 | 88271174 | 75 | 169.90 € | 1 | 695 | 88693173 | 50 | 119.90 € | 1 | 695 |
| 88254183 | 73 | 129.90 € | 1 | 695 | 88271175 | 75 | 169.90 € | 1 | 695 | 88693174 | 50 | 119.90 € | 1 | 695 |
| 88254184 | 73 | 129.90 € | 1 | 695 | 88271183 | 75 | 169.90 € | 1 | 695 | 88693175 | 50 | 119.90 € | 1 | 695 |
| 88254185 | 73 | 129.90 € | 1 | 695 | 88271184 | 75 | 169.90 € | 1 | 695 | 88693183 | 50 | 119.90 € | 1 | 695 |
| 88256163 | 73 | 129.90 € | 1 | 695 | 88271185 | 75 | 169.90 € | 1 | 695 | 88693184 | 50 | 119.90 € | 1 | 695 |
| 88256164 | 73 | 129.90 € | 1 | 695 | 88272163 | 75 | 169.90 € | 1 | 695 | 88693185 | 50 | 119.90 € | 1 | 695 |
| 88256165 | 73 | 129.90 € | 1 | 695 | 88272164 | 75 | 169.90 € | 1 | 695 | 88694163 | 50 | 119.90 € | 1 | 695 |
| 88256173 | 73 | 129.90 € | 1 | 695 | 88272165 | 75 | 169.90 € | 1 | 695 | 88694164 | 50 | 119.90 € | 1 | 695 |
| 88256174 | 73 | 129.90 € | 1 | 695 | 88272173 | 75 | 169.90 € | 1 | 695 | 88694165 | 50 | 119.90 € | 1 | 695 |
| 88256175 | 73 | 129.90 € | 1 | 695 | 88272174 | 75 | 169.90 € | 1 | 695 | 88694173 | 50 | 119.90 € | 1 | 695 |
| 88256183 | 73 | 129.90 € | 1 | 695 | 88272175 | 75 | 169.90 € | 1 | 695 | 88694174 | 50 | 119.90 € | 1 | 695 |
| 88256184 | 73 | 129.90 € | 1 | 695 | 88272183 | 75 | 169.90 € | 1 | 695 | 88694175 | 50 | 119.90 € | 1 | 695 |
| 88256185 | 73 | 129.90 € | 1 | 695 | 88272184 | 75 | 169.90 € | 1 | 695 | 88694183 | 50 | 119.90 € | 1 | 695 |
| 88262163 | 74 | 149.90 € | 1 | 695 | 88272185 | 75 | 169.90 € | 1 | 695 | 88694184 | 50 | 119.90 € | 1 | 695 |
| 88262164 | 74 | 149.90 € | 1 | 695 | 88273163 | 75 | 169.90 € | 1 | 695 | 88694185 | 50 | 119.90 € | 1 | 695 |
| 88262165 | 74 | 149.90 € | 1 | 695 | 88273164 | 75 | 169.90 € | 1 | 695 | 88696163 | 50 | 119.90 € | 1 | 695 |
| 88262173 | 74 | 149.90 € | 1 | 695 | 88273165 | 75 | 169.90 € | 1 | 695 | 88696164 | 50 | 119.90 € | 1 | 695 |
| 88262174 | 74 | 149.90 € | 1 | 695 | 88273173 | 75 | 169.90 € | 1 | 695 | 88696165 | 50 | 119.90 € | 1 | 695 |
| 88262175 | 74 | 149.90 € | 1 | 695 | 88273174 | 75 | 169.90 € | 1 | 695 | 88696173 | 50 | 119.90 € | 1 | 695 |
| 88262183 | 74 | 149.90 € | 1 | 695 | 88273175 | 75 | 169.90 € | 1 | 695 | 88696174 | 50 | 119.90 € | 1 | 695 |
| 88262184 | 74 | 149.90 € | 1 | 695 | 88273183 | 75 | 169.90 € | 1 | 695 | 88696175 | 50 | 119.90 € | 1 | 695 |
| 88262185 | 74 | 149.90 € | 1 | 695 | 88273184 | 75 | 169.90 € | 1 | 695 | 88696183 | 50 | 119.90 € | 1 | 695 |
| 88263163 | 74 | 149.90 € | 1 | 695 | 88273185 | 75 | 169.90 € | 1 | 695 | 88696184 | 50 | 119.90 € | 1 | 695 |
| 88263164 | 74 | 149.90 € | 1 | 695 | 88274163 | 75 | 169.90 € | 1 | 695 | 88696185 | 50 | 119.90 € | 1 | 695 |
| 88263165 | 74 | 149.90 € | 1 | 695 | 88274164 | 75 | 169.90 € | 1 | 695 | 88702163 | 51 | 142.90 € | 1 | 695 |
| 88263173 | 74 | 149.90 € | 1 | 695 | 88274165 | 75 | 169.90 € | 1 | 695 | 88702164 | 51 | 142.90 € | 1 | 695 |
| 88263174 | 74 | 149.90 € | 1 | 695 | 88274173 | 75 | 169.90 € | 1 | 695 | 88702165 | 51 | 142.90 € | 1 | 695 |
| 88263175 | 74 | 149.90 € | 1 | 695 | 88274174 | 75 | 169.90 € | 1 | 695 | 88702173 | 51 | 142.90 € | 1 | 695 |
| 88263183 | 74 | 149.90 € | 1 | 695 | 88274175 | 75 | 169.90 € | 1 | 695 | 88702174 | 51 | 142.90 € | 1 | 695 |
| 88263184 | 74 | 149.90 € | 1 | 695 | 88274183 | 75 | 169.90 € | 1 | 695 | 88702175 | 51 | 142.90 € | 1 | 695 |
| 88263185 | 74 | 149.90 € | 1 | 695 | 88274184 | 75 | 169.90 € | 1 | 695 | 88702183 | 51 | 142.90 € | 1 | 695 |
| 88266163 | 74 | 149.90 € | 1 | 695 | 88274185 | 75 | 169.90 € | 1 | 695 | 88702184 | 51 | 142.90 € | 1 | 695 |
| 88266164 | 74 | 149.90 € | 1 | 695 | 88276163 | 75 | 169.90 € | 1 | 695 | 88702185 | 51 | 142.90 € | 1 | 695 |
| 88266165 | 74 | 149.90 € | 1 | 695 | 88276164 | 75 | 169.90 € | 1 | 695 | 88704163 | 51 | 142.90 € | 1 | 695 |

| Article no. | Page | Price in € | Discount group | Product group | Article no. | Page | Price in € | Discount group | Product group | Article no. | Page | Price in € | Discount group | Product group |
|-------------|------|------------|----------------|---------------|-------------|------|------------|----------------|---------------|-------------|------|------------|----------------|---------------|
| 88704164 | 51 | 142.90 € | 1 | 695 | 88722163 | 53 | 205.90 € | 1 | 695 | 88734185 | 58 | 99.90 € | 1 | 679 |
| 88704165 | 51 | 142.90 € | 1 | 695 | 88722164 | 53 | 205.90 € | 1 | 695 | 88736163 | 58 | 99.90 € | 1 | 679 |
| 88704173 | 51 | 142.90 € | 1 | 695 | 88722165 | 53 | 205.90 € | 1 | 695 | 88736164 | 58 | 99.90 € | 1 | 679 |
| 88704174 | 51 | 142.90 € | 1 | 695 | 88722173 | 53 | 205.90 € | 1 | 695 | 88736165 | 58 | 99.90 € | 1 | 679 |
| 88704175 | 51 | 142.90 € | 1 | 695 | 88722174 | 53 | 205.90 € | 1 | 695 | 88736173 | 58 | 99.90 € | 1 | 679 |
| 88704183 | 51 | 142.90 € | 1 | 695 | 88722175 | 53 | 205.90 € | 1 | 695 | 88736174 | 58 | 99.90 € | 1 | 679 |
| 88704184 | 51 | 142.90 € | 1 | 695 | 88722183 | 53 | 205.90 € | 1 | 695 | 88736175 | 58 | 99.90 € | 1 | 679 |
| 88704185 | 51 | 142.90 € | 1 | 695 | 88722184 | 53 | 205.90 € | 1 | 695 | 88736183 | 58 | 99.90 € | 1 | 679 |
| 88706163 | 51 | 142.90 € | 1 | 695 | 88722185 | 53 | 205.90 € | 1 | 695 | 88736184 | 58 | 99.90 € | 1 | 679 |
| 88706164 | 51 | 142.90 € | 1 | 695 | 88723163 | 53 | 205.90 € | 1 | 695 | 88736185 | 58 | 99.90 € | 1 | 679 |
| 88706165 | 51 | 142.90 € | 1 | 695 | 88723164 | 53 | 205.90 € | 1 | 695 | 88742163 | 59 | 139.90 € | 1 | 679 |
| 88706173 | 51 | 142.90 € | 1 | 695 | 88723165 | 53 | 205.90 € | 1 | 695 | 88742164 | 59 | 139.90 € | 1 | 679 |
| 88706174 | 51 | 142.90 € | 1 | 695 | 88723173 | 53 | 205.90 € | 1 | 695 | 88742165 | 59 | 139.90 € | 1 | 679 |
| 88706175 | 51 | 142.90 € | 1 | 695 | 88723174 | 53 | 205.90 € | 1 | 695 | 88742173 | 59 | 139.90 € | 1 | 679 |
| 88706183 | 51 | 142.90 € | 1 | 695 | 88723175 | 53 | 205.90 € | 1 | 695 | 88742174 | 59 | 139.90 € | 1 | 679 |
| 88706184 | 51 | 142.90 € | 1 | 695 | 88723183 | 53 | 205.90 € | 1 | 695 | 88742175 | 59 | 139.90 € | 1 | 679 |
| 88706185 | 51 | 142.90 € | 1 | 695 | 88723184 | 53 | 205.90 € | 1 | 695 | 88742183 | 59 | 139.90 € | 1 | 679 |
| 88712163 | 52 | 182.90 € | 1 | 695 | 88723185 | 53 | 205.90 € | 1 | 695 | 88742184 | 59 | 139.90 € | 1 | 679 |
| 88712164 | 52 | 182.90 € | 1 | 695 | 88724163 | 53 | 205.90 € | 1 | 695 | 88742185 | 59 | 139.90 € | 1 | 679 |
| 88712165 | 52 | 182.90 € | 1 | 695 | 88724164 | 53 | 205.90 € | 1 | 695 | 88744163 | 59 | 139.90 € | 1 | 679 |
| 88712173 | 52 | 182.90 € | 1 | 695 | 88724165 | 53 | 205.90 € | 1 | 695 | 88744164 | 59 | 139.90 € | 1 | 679 |
| 88712174 | 52 | 182.90 € | 1 | 695 | 88724173 | 53 | 205.90 € | 1 | 695 | 88744165 | 59 | 139.90 € | 1 | 679 |
| 88712175 | 52 | 182.90 € | 1 | 695 | 88724174 | 53 | 205.90 € | 1 | 695 | 88744173 | 59 | 139.90 € | 1 | 679 |
| 88712183 | 52 | 182.90 € | 1 | 695 | 88724175 | 53 | 205.90 € | 1 | 695 | 88744174 | 59 | 139.90 € | 1 | 679 |
| 88712184 | 52 | 182.90 € | 1 | 695 | 88724183 | 53 | 205.90 € | 1 | 695 | 88744175 | 59 | 139.90 € | 1 | 679 |
| 88712185 | 52 | 182.90 € | 1 | 695 | 88724184 | 53 | 205.90 € | 1 | 695 | 88744183 | 59 | 139.90 € | 1 | 679 |
| 88713163 | 52 | 182.90 € | 1 | 695 | 88724185 | 53 | 205.90 € | 1 | 695 | 88744184 | 59 | 139.90 € | 1 | 679 |
| 88713164 | 52 | 182.90 € | 1 | 695 | 88733163 | 58 | 99.90 € | 1 | 679 | 88744185 | 59 | 139.90 € | 1 | 679 |
| 88713165 | 52 | 182.90 € | 1 | 695 | 88733164 | 58 | 99.90 € | 1 | 679 | 88746163 | 59 | 139.90 € | 1 | 679 |
| 88713173 | 52 | 182.90 € | 1 | 695 | 88733165 | 58 | 99.90 € | 1 | 679 | 88746164 | 59 | 139.90 € | 1 | 679 |
| 88713174 | 52 | 182.90 € | 1 | 695 | 88733173 | 58 | 99.90 € | 1 | 679 | 88746165 | 59 | 139.90 € | 1 | 679 |
| 88713175 | 52 | 182.90 € | 1 | 695 | 88733174 | 58 | 99.90 € | 1 | 679 | 88746173 | 59 | 139.90 € | 1 | 679 |
| 88713183 | 52 | 182.90 € | 1 | 695 | 88733175 | 58 | 99.90 € | 1 | 679 | 88746174 | 59 | 139.90 € | 1 | 679 |
| 88713184 | 52 | 182.90 € | 1 | 695 | 88733183 | 58 | 99.90 € | 1 | 679 | 88746175 | 59 | 139.90 € | 1 | 679 |
| 88713185 | 52 | 182.90 € | 1 | 695 | 88733184 | 58 | 99.90 € | 1 | 679 | 88746183 | 59 | 139.90 € | 1 | 679 |
| 88715163 | 52 | 182.90 € | 1 | 695 | 88733185 | 58 | 99.90 € | 1 | 679 | 88746184 | 59 | 139.90 € | 1 | 679 |
| 88715164 | 52 | 182.90 € | 1 | 695 | 88734163 | 58 | 99.90 € | 1 | 679 | 88746185 | 59 | 139.90 € | 1 | 679 |
| 88715165 | 52 | 182.90 € | 1 | 695 | 88734164 | 58 | 99.90 € | 1 | 679 | 88752163 | 60 | 179.90 € | 1 | 679 |
| 88715173 | 52 | 182.90 € | 1 | 695 | 88734165 | 58 | 99.90 € | 1 | 679 | 88752164 | 60 | 179.90 € | 1 | 679 |
| 88715174 | 52 | 182.90 € | 1 | 695 | 88734173 | 58 | 99.90 € | 1 | 679 | 88752165 | 60 | 179.90 € | 1 | 679 |
| 88715175 | 52 | 182.90 € | 1 | 695 | 88734174 | 58 | 99.90 € | 1 | 679 | 88752173 | 60 | 179.90 € | 1 | 679 |
| 88715183 | 52 | 182.90 € | 1 | 695 | 88734175 | 58 | 99.90 € | 1 | 679 | 88752174 | 60 | 179.90 € | 1 | 679 |
| 88715184 | 52 | 182.90 € | 1 | 695 | 88734183 | 58 | 99.90 € | 1 | 679 | 88752175 | 60 | 179.90 € | 1 | 679 |
| 88715185 | 52 | 182.90 € | 1 | 695 | 88734184 | 58 | 99.90 € | 1 | 679 | 88752183 | 60 | 179.90 € | 1 | 679 |

| Article no. | Page | Price in € | Discount group | Product group | Article no. | Page | Price in € | Discount group | Product group | Article no. | Page | Price in € | Discount group | Product group |
|-------------|------|------------|----------------|---------------|-------------|------|------------|----------------|---------------|-------------|------|------------|----------------|---------------|
| 88752184 | 60 | 179.90 € | 1 | 679 | 88764183 | 61 | 199.90 € | 1 | 679 | 88784175 | 55 | 122.90 € | 1 | 679 |
| 88752185 | 60 | 179.90 € | 1 | 679 | 88764184 | 61 | 199.90 € | 1 | 679 | 88784183 | 55 | 122.90 € | 1 | 679 |
| 88753163 | 60 | 179.90 € | 1 | 679 | 88764185 | 61 | 199.90 € | 1 | 679 | 88784184 | 55 | 122.90 € | 1 | 679 |
| 88753164 | 60 | 179.90 € | 1 | 679 | 88773163 | 54 | 99.90 € | 1 | 679 | 88784185 | 55 | 122.90 € | 1 | 679 |
| 88753165 | 60 | 179.90 € | 1 | 679 | 88773164 | 54 | 99.90 € | 1 | 679 | 88786163 | 55 | 122.90 € | 1 | 679 |
| 88753173 | 60 | 179.90 € | 1 | 679 | 88773165 | 54 | 99.90 € | 1 | 679 | 88786164 | 55 | 122.90 € | 1 | 679 |
| 88753174 | 60 | 179.90 € | 1 | 679 | 88773173 | 54 | 99.90 € | 1 | 679 | 88786165 | 55 | 122.90 € | 1 | 679 |
| 88753175 | 60 | 179.90 € | 1 | 679 | 88773174 | 54 | 99.90 € | 1 | 679 | 88786173 | 55 | 122.90 € | 1 | 679 |
| 88753183 | 60 | 179.90 € | 1 | 679 | 88773175 | 54 | 99.90 € | 1 | 679 | 88786174 | 55 | 122.90 € | 1 | 679 |
| 88753184 | 60 | 179.90 € | 1 | 679 | 88773183 | 54 | 99.90 € | 1 | 679 | 88786175 | 55 | 122.90 € | 1 | 679 |
| 88753185 | 60 | 179.90 € | 1 | 679 | 88773184 | 54 | 99.90 € | 1 | 679 | 88786183 | 55 | 122.90 € | 1 | 679 |
| 88755163 | 60 | 179.90 € | 1 | 679 | 88773185 | 54 | 99.90 € | 1 | 679 | 88786184 | 55 | 122.90 € | 1 | 679 |
| 88755164 | 60 | 179.90 € | 1 | 679 | 88774163 | 54 | 99.90 € | 1 | 679 | 88786185 | 55 | 122.90 € | 1 | 679 |
| 88755165 | 60 | 179.90 € | 1 | 679 | 88774164 | 54 | 99.90 € | 1 | 679 | 88792163 | 56 | 168.90 € | 1 | 679 |
| 88755173 | 60 | 179.90 € | 1 | 679 | 88774165 | 54 | 99.90 € | 1 | 679 | 88792164 | 56 | 168.90 € | 1 | 679 |
| 88755174 | 60 | 179.90 € | 1 | 679 | 88774173 | 54 | 99.90 € | 1 | 679 | 88792165 | 56 | 168.90 € | 1 | 679 |
| 88755175 | 60 | 179.90 € | 1 | 679 | 88774174 | 54 | 99.90 € | 1 | 679 | 88792173 | 56 | 168.90 € | 1 | 679 |
| 88755183 | 60 | 179.90 € | 1 | 679 | 88774175 | 54 | 99.90 € | 1 | 679 | 88792174 | 56 | 168.90 € | 1 | 679 |
| 88755184 | 60 | 179.90 € | 1 | 679 | 88774183 | 54 | 99.90 € | 1 | 679 | 88792175 | 56 | 168.90 € | 1 | 679 |
| 88755185 | 60 | 179.90 € | 1 | 679 | 88774184 | 54 | 99.90 € | 1 | 679 | 88792183 | 56 | 168.90 € | 1 | 679 |
| 88762163 | 61 | 199.90 € | 1 | 679 | 88774185 | 54 | 99.90 € | 1 | 679 | 88792184 | 56 | 168.90 € | 1 | 679 |
| 88762164 | 61 | 199.90 € | 1 | 679 | 88776163 | 54 | 99.90 € | 1 | 679 | 88792185 | 56 | 168.90 € | 1 | 679 |
| 88762165 | 61 | 199.90 € | 1 | 679 | 88776164 | 54 | 99.90 € | 1 | 679 | 88793163 | 56 | 168.90 € | 1 | 679 |
| 88762173 | 61 | 199.90 € | 1 | 679 | 88776165 | 54 | 99.90 € | 1 | 679 | 88793164 | 56 | 168.90 € | 1 | 679 |
| 88762174 | 61 | 199.90 € | 1 | 679 | 88776173 | 54 | 99.90 € | 1 | 679 | 88793165 | 56 | 168.90 € | 1 | 679 |
| 88762175 | 61 | 199.90 € | 1 | 679 | 88776174 | 54 | 99.90 € | 1 | 679 | 88793173 | 56 | 168.90 € | 1 | 679 |
| 88762183 | 61 | 199.90 € | 1 | 679 | 88776175 | 54 | 99.90 € | 1 | 679 | 88793174 | 56 | 168.90 € | 1 | 679 |
| 88762184 | 61 | 199.90 € | 1 | 679 | 88776183 | 54 | 99.90 € | 1 | 679 | 88793175 | 56 | 168.90 € | 1 | 679 |
| 88762185 | 61 | 199.90 € | 1 | 679 | 88776184 | 54 | 99.90 € | 1 | 679 | 88793183 | 56 | 168.90 € | 1 | 679 |
| 88763163 | 61 | 199.90 € | 1 | 679 | 88776185 | 54 | 99.90 € | 1 | 679 | 88793184 | 56 | 168.90 € | 1 | 679 |
| 88763164 | 61 | 199.90 € | 1 | 679 | 88782163 | 55 | 122.90 € | 1 | 679 | 88793185 | 56 | 168.90 € | 1 | 679 |
| 88763165 | 61 | 199.90 € | 1 | 679 | 88782164 | 55 | 122.90 € | 1 | 679 | 88795163 | 56 | 168.90 € | 1 | 679 |
| 88763173 | 61 | 199.90 € | 1 | 679 | 88782165 | 55 | 122.90 € | 1 | 679 | 88795164 | 56 | 168.90 € | 1 | 679 |
| 88763174 | 61 | 199.90 € | 1 | 679 | 88782173 | 55 | 122.90 € | 1 | 679 | 88795165 | 56 | 168.90 € | 1 | 679 |
| 88763175 | 61 | 199.90 € | 1 | 679 | 88782174 | 55 | 122.90 € | 1 | 679 | 88795173 | 56 | 168.90 € | 1 | 679 |
| 88763183 | 61 | 199.90 € | 1 | 679 | 88782175 | 55 | 122.90 € | 1 | 679 | 88795174 | 56 | 168.90 € | 1 | 679 |
| 88763184 | 61 | 199.90 € | 1 | 679 | 88782183 | 55 | 122.90 € | 1 | 679 | 88795175 | 56 | 168.90 € | 1 | 679 |
| 88763185 | 61 | 199.90 € | 1 | 679 | 88782184 | 55 | 122.90 € | 1 | 679 | 88795183 | 56 | 168.90 € | 1 | 679 |
| 88764163 | 61 | 199.90 € | 1 | 679 | 88782185 | 55 | 122.90 € | 1 | 679 | 88795184 | 56 | 168.90 € | 1 | 679 |
| 88764164 | 61 | 199.90 € | 1 | 679 | 88784163 | 55 | 122.90 € | 1 | 679 | 88795185 | 56 | 168.90 € | 1 | 679 |
| 88764165 | 61 | 199.90 € | 1 | 679 | 88784164 | 55 | 122.90 € | 1 | 679 | 88802163 | 57 | 191.90 € | 1 | 679 |
| 88764173 | 61 | 199.90 € | 1 | 679 | 88784165 | 55 | 122.90 € | 1 | 679 | 88802164 | 57 | 191.90 € | 1 | 679 |
| 88764174 | 61 | 199.90 € | 1 | 679 | 88784173 | 55 | 122.90 € | 1 | 679 | 88802165 | 57 | 191.90 € | 1 | 679 |
| 88764175 | 61 | 199.90 € | 1 | 679 | 88784174 | 55 | 122.90 € | 1 | 679 | 88802173 | 57 | 191.90 € | 1 | 679 |

| Article no. | Page | Price in € | Discount group | Product group | Article no. | Page | Price in € | Discount group | Product group | Article no. | Page | Price in € | Discount group | Product group |
|-------------|------|------------|----------------|---------------|-------------|------|------------|----------------|---------------|-------------|------|------------|----------------|---------------|
| 88802174 | 57 | 191.90 € | 1 | 679 | 88816173 | 62 | 94.90 € | 1 | 695 | 88833165 | 64 | 155.90 € | 1 | 695 |
| 88802175 | 57 | 191.90 € | 1 | 679 | 88816174 | 62 | 94.90 € | 1 | 695 | 88833173 | 64 | 155.90 € | 1 | 695 |
| 88802183 | 57 | 191.90 € | 1 | 679 | 88816175 | 62 | 94.90 € | 1 | 695 | 88833174 | 64 | 155.90 € | 1 | 695 |
| 88802184 | 57 | 191.90 € | 1 | 679 | 88816183 | 62 | 94.90 € | 1 | 695 | 88833175 | 64 | 155.90 € | 1 | 695 |
| 88802185 | 57 | 191.90 € | 1 | 679 | 88816184 | 62 | 94.90 € | 1 | 695 | 88833183 | 64 | 155.90 € | 1 | 695 |
| 88803163 | 57 | 191.90 € | 1 | 679 | 88816185 | 62 | 94.90 € | 1 | 695 | 88833184 | 64 | 155.90 € | 1 | 695 |
| 88803164 | 57 | 191.90 € | 1 | 679 | 88822163 | 63 | 114.90 € | 1 | 695 | 88833185 | 64 | 155.90 € | 1 | 695 |
| 88803165 | 57 | 191.90 € | 1 | 679 | 88822164 | 63 | 114.90 € | 1 | 695 | 88835163 | 64 | 155.90 € | 1 | 695 |
| 88803173 | 57 | 191.90 € | 1 | 679 | 88822165 | 63 | 114.90 € | 1 | 695 | 88835164 | 64 | 155.90 € | 1 | 695 |
| 88803174 | 57 | 191.90 € | 1 | 679 | 88822173 | 63 | 114.90 € | 1 | 695 | 88835165 | 64 | 155.90 € | 1 | 695 |
| 88803175 | 57 | 191.90 € | 1 | 679 | 88822174 | 63 | 114.90 € | 1 | 695 | 88835173 | 64 | 155.90 € | 1 | 695 |
| 88803183 | 57 | 191.90 € | 1 | 679 | 88822175 | 63 | 114.90 € | 1 | 695 | 88835174 | 64 | 155.90 € | 1 | 695 |
| 88803184 | 57 | 191.90 € | 1 | 679 | 88822183 | 63 | 114.90 € | 1 | 695 | 88835175 | 64 | 155.90 € | 1 | 695 |
| 88803185 | 57 | 191.90 € | 1 | 679 | 88822184 | 63 | 114.90 € | 1 | 695 | 88835183 | 64 | 155.90 € | 1 | 695 |
| 88804163 | 57 | 191.90 € | 1 | 679 | 88822185 | 63 | 114.90 € | 1 | 695 | 88835184 | 64 | 155.90 € | 1 | 695 |
| 88804164 | 57 | 191.90 € | 1 | 679 | 88824163 | 63 | 114.90 € | 1 | 695 | 88835185 | 64 | 155.90 € | 1 | 695 |
| 88804165 | 57 | 191.90 € | 1 | 679 | 88824164 | 63 | 114.90 € | 1 | 695 | 88842163 | 65 | 172.90 € | 1 | 695 |
| 88804173 | 57 | 191.90 € | 1 | 679 | 88824165 | 63 | 114.90 € | 1 | 695 | 88842164 | 65 | 172.90 € | 1 | 695 |
| 88804174 | 57 | 191.90 € | 1 | 679 | 88824173 | 63 | 114.90 € | 1 | 695 | 88842165 | 65 | 172.90 € | 1 | 695 |
| 88804175 | 57 | 191.90 € | 1 | 679 | 88824174 | 63 | 114.90 € | 1 | 695 | 88842173 | 65 | 172.90 € | 1 | 695 |
| 88804183 | 57 | 191.90 € | 1 | 679 | 88824175 | 63 | 114.90 € | 1 | 695 | 88842174 | 65 | 172.90 € | 1 | 695 |
| 88804184 | 57 | 191.90 € | 1 | 679 | 88824183 | 63 | 114.90 € | 1 | 695 | 88842175 | 65 | 172.90 € | 1 | 695 |
| 88804185 | 57 | 191.90 € | 1 | 679 | 88824184 | 63 | 114.90 € | 1 | 695 | 88842183 | 65 | 172.90 € | 1 | 695 |
| 88813163 | 62 | 94.90 € | 1 | 695 | 88824185 | 63 | 114.90 € | 1 | 695 | 88842184 | 65 | 172.90 € | 1 | 695 |
| 88813164 | 62 | 94.90 € | 1 | 695 | 88826163 | 63 | 114.90 € | 1 | 695 | 88842185 | 65 | 172.90 € | 1 | 695 |
| 88813165 | 62 | 94.90 € | 1 | 695 | 88826164 | 63 | 114.90 € | 1 | 695 | 88843163 | 65 | 172.90 € | 1 | 695 |
| 88813173 | 62 | 94.90 € | 1 | 695 | 88826165 | 63 | 114.90 € | 1 | 695 | 88843164 | 65 | 172.90 € | 1 | 695 |
| 88813174 | 62 | 94.90 € | 1 | 695 | 88826173 | 63 | 114.90 € | 1 | 695 | 88843165 | 65 | 172.90 € | 1 | 695 |
| 88813175 | 62 | 94.90 € | 1 | 695 | 88826174 | 63 | 114.90 € | 1 | 695 | 88843173 | 65 | 172.90 € | 1 | 695 |
| 88813183 | 62 | 94.90 € | 1 | 695 | 88826175 | 63 | 114.90 € | 1 | 695 | 88843174 | 65 | 172.90 € | 1 | 695 |
| 88813184 | 62 | 94.90 € | 1 | 695 | 88826183 | 63 | 114.90 € | 1 | 695 | 88843175 | 65 | 172.90 € | 1 | 695 |
| 88813185 | 62 | 94.90 € | 1 | 695 | 88826184 | 63 | 114.90 € | 1 | 695 | 88843183 | 65 | 172.90 € | 1 | 695 |
| 88814163 | 62 | 94.90 € | 1 | 695 | 88826185 | 63 | 114.90 € | 1 | 695 | 88843184 | 65 | 172.90 € | 1 | 695 |
| 88814164 | 62 | 94.90 € | 1 | 695 | 88832163 | 64 | 155.90 € | 1 | 695 | 88843185 | 65 | 172.90 € | 1 | 695 |
| 88814165 | 62 | 94.90 € | 1 | 695 | 88832164 | 64 | 155.90 € | 1 | 695 | 88844163 | 65 | 172.90 € | 1 | 695 |
| 88814173 | 62 | 94.90 € | 1 | 695 | 88832165 | 64 | 155.90 € | 1 | 695 | 88844164 | 65 | 172.90 € | 1 | 695 |
| 88814174 | 62 | 94.90 € | 1 | 695 | 88832173 | 64 | 155.90 € | 1 | 695 | 88844165 | 65 | 172.90 € | 1 | 695 |
| 88814175 | 62 | 94.90 € | 1 | 695 | 88832174 | 64 | 155.90 € | 1 | 695 | 88844173 | 65 | 172.90 € | 1 | 695 |
| 88814183 | 62 | 94.90 € | 1 | 695 | 88832175 | 64 | 155.90 € | 1 | 695 | 88844174 | 65 | 172.90 € | 1 | 695 |
| 88814184 | 62 | 94.90 € | 1 | 695 | 88832183 | 64 | 155.90 € | 1 | 695 | 88844175 | 65 | 172.90 € | 1 | 695 |
| 88814185 | 62 | 94.90 € | 1 | 695 | 88832184 | 64 | 155.90 € | 1 | 695 | 88844183 | 65 | 172.90 € | 1 | 695 |
| 88816163 | 62 | 94.90 € | 1 | 695 | 88832185 | 64 | 155.90 € | 1 | 695 | 88844184 | 65 | 172.90 € | 1 | 695 |
| 88816164 | 62 | 94.90 € | 1 | 695 | 88833163 | 64 | 155.90 € | 1 | 695 | 88844185 | 65 | 172.90 € | 1 | 695 |
| 88816165 | 62 | 94.90 € | 1 | 695 | 88833164 | 64 | 155.90 € | 1 | 695 | 88853163 | 66 | 114.90 € | 1 | 695 |

| Article no. | Page | Price in € | Discount group | Product group | Article no. | Page | Price in € | Discount group | Product group | Article no. | Page | Price in € | Discount group | Product group |
|-------------|------|------------|----------------|---------------|-------------|------|------------|----------------|---------------|-------------|------|------------|----------------|---------------|
| 88853164 | 66 | 114.90 € | 1 | 695 | 88866163 | 67 | 135.90 € | 1 | 695 | 88882185 | 69 | 193.90 € | 1 | 695 |
| 88853165 | 66 | 114.90 € | 1 | 695 | 88866164 | 67 | 135.90 € | 1 | 695 | 88883163 | 69 | 193.90 € | 1 | 695 |
| 88853173 | 66 | 114.90 € | 1 | 695 | 88866165 | 67 | 135.90 € | 1 | 695 | 88883164 | 69 | 193.90 € | 1 | 695 |
| 88853174 | 66 | 114.90 € | 1 | 695 | 88866173 | 67 | 135.90 € | 1 | 695 | 88883165 | 69 | 193.90 € | 1 | 695 |
| 88853175 | 66 | 114.90 € | 1 | 695 | 88866174 | 67 | 135.90 € | 1 | 695 | 88883173 | 69 | 193.90 € | 1 | 695 |
| 88853183 | 66 | 114.90 € | 1 | 695 | 88866175 | 67 | 135.90 € | 1 | 695 | 88883174 | 69 | 193.90 € | 1 | 695 |
| 88853184 | 66 | 114.90 € | 1 | 695 | 88866183 | 67 | 135.90 € | 1 | 695 | 88883175 | 69 | 193.90 € | 1 | 695 |
| 88853185 | 66 | 114.90 € | 1 | 695 | 88866184 | 67 | 135.90 € | 1 | 695 | 88883183 | 69 | 193.90 € | 1 | 695 |
| 88854163 | 66 | 114.90 € | 1 | 695 | 88866185 | 67 | 135.90 € | 1 | 695 | 88883184 | 69 | 193.90 € | 1 | 695 |
| 88854164 | 66 | 114.90 € | 1 | 695 | 88872163 | 68 | 175.90 € | 1 | 695 | 88883185 | 69 | 193.90 € | 1 | 695 |
| 88854165 | 66 | 114.90 € | 1 | 695 | 88872164 | 68 | 175.90 € | 1 | 695 | 88884163 | 69 | 193.90 € | 1 | 695 |
| 88854173 | 66 | 114.90 € | 1 | 695 | 88872165 | 68 | 175.90 € | 1 | 695 | 88884164 | 69 | 193.90 € | 1 | 695 |
| 88854174 | 66 | 114.90 € | 1 | 695 | 88872173 | 68 | 175.90 € | 1 | 695 | 88884165 | 69 | 193.90 € | 1 | 695 |
| 88854175 | 66 | 114.90 € | 1 | 695 | 88872174 | 68 | 175.90 € | 1 | 695 | 88884173 | 69 | 193.90 € | 1 | 695 |
| 88854183 | 66 | 114.90 € | 1 | 695 | 88872175 | 68 | 175.90 € | 1 | 695 | 88884174 | 69 | 193.90 € | 1 | 695 |
| 88854184 | 66 | 114.90 € | 1 | 695 | 88872183 | 68 | 175.90 € | 1 | 695 | 88884175 | 69 | 193.90 € | 1 | 695 |
| 88854185 | 66 | 114.90 € | 1 | 695 | 88872184 | 68 | 175.90 € | 1 | 695 | 88884183 | 69 | 193.90 € | 1 | 695 |
| 88856163 | 66 | 114.90 € | 1 | 695 | 88872185 | 68 | 175.90 € | 1 | 695 | 88884184 | 69 | 193.90 € | 1 | 695 |
| 88856164 | 66 | 114.90 € | 1 | 695 | 88873163 | 68 | 175.90 € | 1 | 695 | 88884185 | 69 | 193.90 € | 1 | 695 |
| 88856165 | 66 | 114.90 € | 1 | 695 | 88873164 | 68 | 175.90 € | 1 | 695 | P3817WW | 390 | 148.30 € | 1 | 693 |
| 88856173 | 66 | 114.90 € | 1 | 695 | 88873165 | 68 | 175.90 € | 1 | 695 | | | | | |
| 88856174 | 66 | 114.90 € | 1 | 695 | 88873173 | 68 | 175.90 € | 1 | 695 | | | | | |
| 88856175 | 66 | 114.90 € | 1 | 695 | 88873174 | 68 | 175.90 € | 1 | 695 | | | | | |
| 88856183 | 66 | 114.90 € | 1 | 695 | 88873175 | 68 | 175.90 € | 1 | 695 | | | | | |
| 88856184 | 66 | 114.90 € | 1 | 695 | 88873183 | 68 | 175.90 € | 1 | 695 | | | | | |
| 88856185 | 66 | 114.90 € | 1 | 695 | 88873184 | 68 | 175.90 € | 1 | 695 | | | | | |
| 88862163 | 67 | 135.90 € | 1 | 695 | 88873185 | 68 | 175.90 € | 1 | 695 | | | | | |
| 88862164 | 67 | 135.90 € | 1 | 695 | 88875163 | 68 | 175.90 € | 1 | 695 | | | | | |
| 88862165 | 67 | 135.90 € | 1 | 695 | 88875164 | 68 | 175.90 € | 1 | 695 | | | | | |
| 88862173 | 67 | 135.90 € | 1 | 695 | 88875165 | 68 | 175.90 € | 1 | 695 | | | | | |
| 88862174 | 67 | 135.90 € | 1 | 695 | 88875173 | 68 | 175.90 € | 1 | 695 | | | | | |
| 88862175 | 67 | 135.90 € | 1 | 695 | 88875174 | 68 | 175.90 € | 1 | 695 | | | | | |
| 88862183 | 67 | 135.90 € | 1 | 695 | 88875175 | 68 | 175.90 € | 1 | 695 | | | | | |
| 88862184 | 67 | 135.90 € | 1 | 695 | 88875183 | 68 | 175.90 € | 1 | 695 | | | | | |
| 88862185 | 67 | 135.90 € | 1 | 695 | 88875184 | 68 | 175.90 € | 1 | 695 | | | | | |
| 88864163 | 67 | 135.90 € | 1 | 695 | 88875185 | 68 | 175.90 € | 1 | 695 | | | | | |
| 88864164 | 67 | 135.90 € | 1 | 695 | 88882163 | 69 | 193.90 € | 1 | 695 | | | | | |
| 88864165 | 67 | 135.90 € | 1 | 695 | 88882164 | 69 | 193.90 € | 1 | 695 | | | | | |
| 88864173 | 67 | 135.90 € | 1 | 695 | 88882165 | 69 | 193.90 € | 1 | 695 | | | | | |
| 88864174 | 67 | 135.90 € | 1 | 695 | 88882173 | 69 | 193.90 € | 1 | 695 | | | | | |
| 88864175 | 67 | 135.90 € | 1 | 695 | 88882174 | 69 | 193.90 € | 1 | 695 | | | | | |
| 88864183 | 67 | 135.90 € | 1 | 695 | 88882175 | 69 | 193.90 € | 1 | 695 | | | | | |
| 88864184 | 67 | 135.90 € | 1 | 695 | 88882183 | 69 | 193.90 € | 1 | 695 | | | | | |
| 88864185 | 67 | 135.90 € | 1 | 695 | 88882184 | 69 | 193.90 € | 1 | 695 | | | | | |

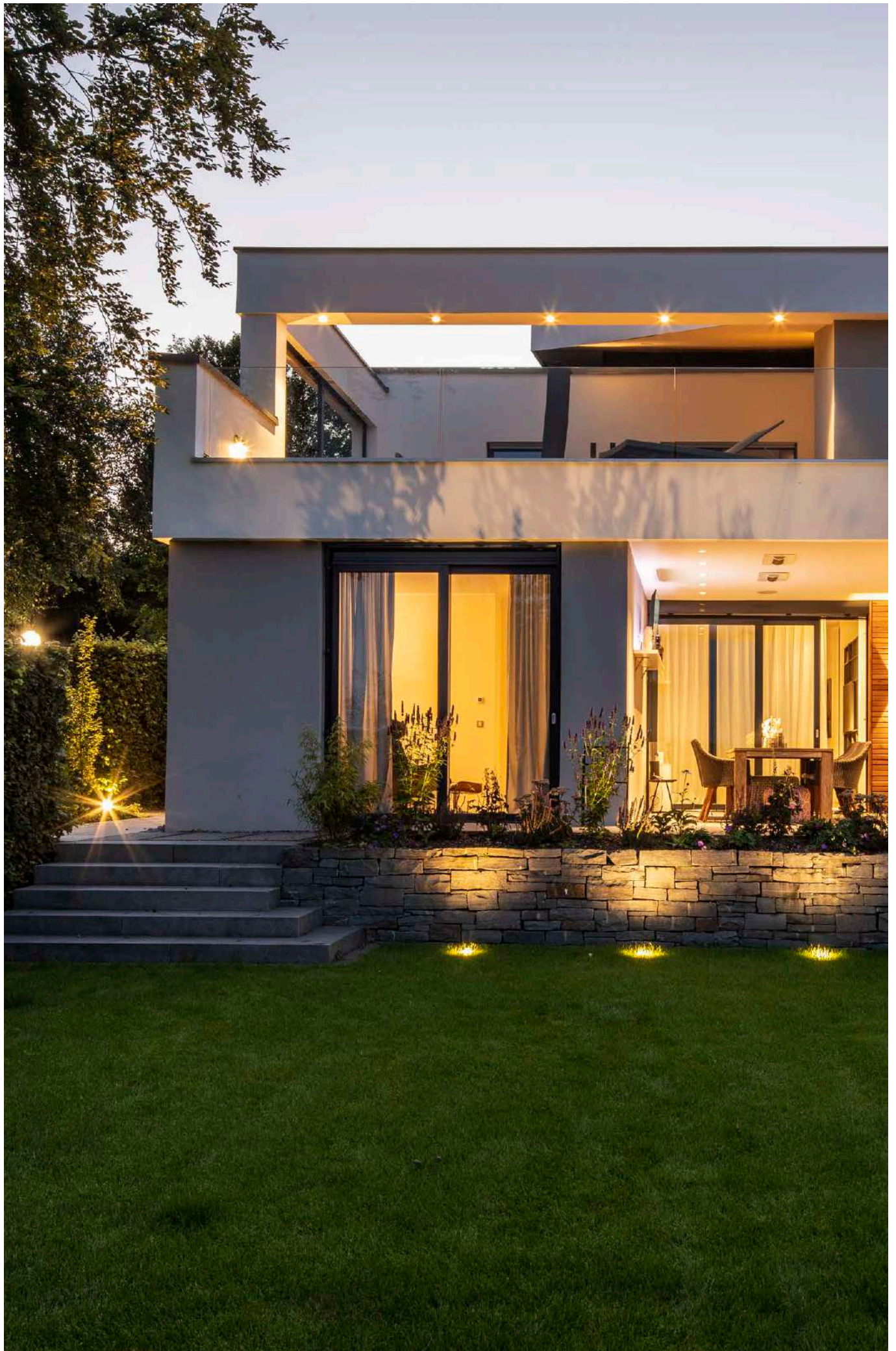

General Terms and Conditions of Sale

1. General - Scope

1.1 Our Terms and Conditions of Sale shall apply exclusively; we do not recognise any terms and conditions of the Purchaser that conflict with or deviate from our Terms and Conditions of Sale unless we have expressly agreed to their validity in writing. Our Terms and Conditions of Sale shall also apply if we carry out the delivery to the purchaser without reservation in the knowledge that the purchaser's terms and conditions conflict with or deviate from our Terms and Conditions of Sale.

1.2 Our written offer is decisive for the content and scope of deliveries and services and, if we issue an order confirmation, it is our written order confirmation.

1.3 Our Terms and Conditions of Sale shall only apply to companies within the meaning of Article 14 of the German Civil Code (BGB), legal entities under public law and special funds under public law.

1.4 The following terms and conditions shall take precedence over deviating terms and conditions of the purchaser. The purchaser's waiver of the validity of any terms and conditions of business of his own shall also not be removed by our silence or our performance. Any deviation from the following conditions requires our written confirmation in individual cases.

1.5 All technical data of our catalogues and other sales documents, lists and drawings as well as weight, dimensional and mixed data have been carefully prepared; in case of errors, we reserve the right to make subsequent corrections.

1.6 It is the responsibility of the purchaser to check whether our product is suitable for their purpose.

1.7 Insofar as declarations according to these Terms and Conditions have to be made in writing, this is also ensured by the text form in accordance with Section 126 b BGB.

2. Offer – Offer documents

2.1 If the order qualifies as an offer in accordance with Section 145 BGB, we can accept it within four weeks.

2.2 We retain the property rights and copyrights to illustrations, drawings, calculations and documents; they may not be made accessible to third parties. This also applies to such written documents that are designated as "confidential". The purchaser must obtain our express written consent before passing them on to third parties. Offers are only valid in written form. The prices quoted are subject to the proviso that the order data on which the quotation was based remain unchanged.

2.3 We shall only produce initial samples and initial sample test reports by express written agreement and at cost.

2.4 Products which are ordered from us by the purchaser on the basis of drawings or samples are subject to the purchaser's obligation to check and not to infringe any third-party property rights. If, in the event of non-compliance with this obligation, we are prohibited by a third party from producing a product with reference to a property right belonging to them, or if the product cannot be used due to the infringement of the property right, we shall be entitled - without examining the legal situation and excluding all claims for damages by the purchaser, irrespective of the legal grounds - to discontinue production and delivery until the facts of the case have been clarified and to demand compensation from the purchaser, at least in the amount of 15% of the invoice value for the product ordered. The purchaser retains the right to provide evidence of lesser damage. The purchaser exempts us on first demand from claims for damages and other claims for compensation by third parties, in particular by holders of rights. The scope of damages shall also include such costs that we incur in defending ourselves against third-party claims.

3. Prices - Payment Terms

3.1 Unless otherwise stated in the order confirmation, our prices shall apply "ex works", including the packaging normally used by us for our products plus the VAT

applicable on the date of invoicing. Requested special packaging or outer packaging or special small packaging will be charged to the purchaser. The prices apply in each case only to the contractually agreed quantity and design. If the purchaser requests changes that require a higher degree of processing than is based on the contract or the usual production process, we reserve the right to make reasonable changes to the prices. We reserve the right to adjust our prices by the amount of the resulting cost increase if our costs increase unforeseeably after conclusion of the contract, in particular due to wage settlements, material price increases, especially raw material price increases or energy cost increases.

3.2 Our prices do not include the statutory VAT; it will be shown separately in the invoice at the statutory rate on the day of invoicing.

3.3 The deduction of an early payment discount requires a special written agreement.

3.4 Unless otherwise stated in the order confirmation, the purchase price (without deduction) to be paid free of charge to the paying agent and is due for payment within 10 days of the invoice date. If the purchaser is in default of payment, we shall be entitled to demand default interest in the amount of 9 percentage points above the statutory base interest rate per annum. If we are able to prove higher losses caused by default, we shall be entitled to assert such losses. However, the purchaser shall be entitled to prove to us that we have incurred no or less loss as a result of the delay in payment.

3.5 The purchaser shall only be entitled to set-off rights if his counter-claims have been legally established, are undisputed or acknowledged by us, or if they are in a reciprocal relationship (synallagma) to the main claim. The purchaser shall only be entitled to a right of retention due to counter-claims which have been established, are undisputed, recognised by us or are in a reciprocal relationship (synallagma) to the main claim. Furthermore, he shall be entitled to exercise a right of retention insofar as his counter-claim is based on the same contractual relationship.

3.6 Credit notes are issued expressly for the purpose of clearing. There is no entitlement to a payout.

3.7 In case of doubt about the solvency of the purchaser, we reserve the right to demand advance payments or securities. If it becomes known to us that attempts to distrain the purchaser have been without success or if we receive indications of the purchaser's financial collapse, we shall be entitled to withdraw from the contract, setting off the expenses incurred.

4. Delivery period – Delivery terms

4.1 The commencement of the delivery period stated by us or agreed with us shall be subject to the clarification of all technical questions, documents to be supplied by the purchaser, necessary approvals and releases, in particular of plans, as well as compliance with the agreed terms of payment and the fulfilment of other co-operative acts by the purchaser.

4.2 Compliance with our delivery obligation further presupposes the timely and proper fulfilment of the purchaser's obligation as well as our proper supply with the raw materials required for the manufacture of the product to be supplied. The objection of non-performance of the contract remains reserved.

4.3 If we are unable to meet binding delivery deadlines for reasons for which we are not responsible, we will inform the purchaser of this immediately and at the same time inform him of the expected new delivery deadline. If delivery is also not possible within the new period, we are entitled to withdraw from the contract in whole or in part; we will immediately reimburse any consideration already paid by the purchaser.

4.4 Where non-compliance with delivery deadlines is due to force majeure, e.g. strike, lockout, pandemic, etc., the deadlines shall be reasonably extended. Such a reasonable extension of the delivery periods shall also occur if we are not supplied correctly and on time (reservation of correct and timely self-delivery).

4.5 If the purchaser is in default of acceptance or culpably violates other obligations to cooperate, we shall be entitled to demand compensation for the losses incurred by us in this respect, including any additional expenses. Further claims or rights are reserved. If the supply, dispatch or delivery is postponed at the request of the purchaser, 10 days after notification that the goods are ready for dispatch, we may charge the purchaser a storage fee of 0.05 % of the invoice amount for each month or part thereof, but not more than 5 % of the invoice amount. Both contracting parties reserve the right to prove higher or lower expenses.

4.6 Provided that the conditions in 4.4 are met, the risk of accidental loss or accidental deterioration of the purchased goods shall pass to the purchaser at the time at which the purchaser is in default of acceptance or debtor's delay.

4.7 We shall be liable in accordance with the statutory provisions insofar as the underlying purchase contract includes a drop dead date within the meaning of Section 286 (2) No. 4 of the German Civil Code (BGB) or Section 376 of the German Commercial Code (HGB). We shall also be liable in accordance with the statutory provisions if, as a consequence of a delay in delivery for which we are responsible, the purchaser justifiably asserts that it is not interested in a continuation of the contract.

4.8 Furthermore, we shall be liable in accordance with the statutory provisions if the delay in delivery is due to an intentional or grossly negligent breach of contract for which we are responsible; fault on the part of our representatives or vicarious agents shall be attributed to us. In the event of force majeure in accordance with 4.3, our representatives or vicarious agents shall not be deemed at fault. If the delay in delivery is due to a grossly negligent breach of contract for which we are responsible, our liability for damages shall be limited to the foreseeable, typically occurring losses.

4.9 We shall also be liable in accordance with the statutory provisions insofar as the delay in delivery for which we are responsible is due to a culpable breach of a material contractual obligation; in this case, however, the liability for damages shall be limited to the foreseeable, typically occurring losses.

4.10 We are entitled to make partial deliveries to a reasonable extent. Deviations with regard to the dimensions, weight, technical design, manufacture and scope of the goods to be delivered shall be permissible within the customary product-specific tolerances. Changes which serve the technical improvement of our products shall also be deemed to have met with the purchaser's approval.

5. Transfer of risk - Packaging costs

5.1 Unless otherwise stated in the order confirmation, delivery is agreed to be "ex works".

5.2 Special agreements apply to the return of packaging.

5.3 If requested by the purchaser, we shall take out transport insurance for the delivery; the costs thereby incurred shall be borne by the purchaser.

5.4 The purchaser is obliged to name one or more persons who are authorised by the purchaser to receive the goods and the accompanying documents and to sign the delivery documents and accompanying papers within a reasonable period before delivery of the goods. This applies in particular if the goods are to be delivered to a place other than the purchaser's registered office. If such information is not provided, the persons who have actually received the goods shall be deemed as entitled to receive the goods and authorised to sign the transfer documents (delivery note and other accompanying documents).

5.5 If no person designated by the purchaser is present at the specified location on the agreed date or if this person or other persons are not willing to accept the goods, the purchaser is in default of acceptance with the consequence that the risk is transferred to him. Furthermore, he has to bear the additional costs incurred as a result of a renewed delivery.

5.6 The purchaser is not permitted to refuse acceptance of deliveries due to minor defects.

6. Liability

6.1 Claims for defects on the part of the purchaser require that the purchaser has properly fulfilled their obligation of examination and complaint in accordance with Section 377 HGB (German Commercial Code).

6.2 Insofar as the purchased item is defective, we shall be entitled, at our discretion, to subsequent performance in the form of rectification of the defect or delivery of a new item free of defects. In the event of rectification of the defect, we shall be obliged to bear all expenses necessary for the purpose of subsequent performance, in particular transport, travel, labour and material costs as well as the expenses for removing the defective item and installing or mounting the rectified or supplied defect-free item, provided that these are not increased by the fact that the purchased item has been transported to a place other than the place of performance, unless such transport corresponds to its intended use. We may refuse supplementary performance if the expenses for remedying the defect are likely to exceed the purchase price. In case of an unjustified request to remedy a defect, we may demand reimbursement of the costs incurred if the purchaser knew or could have recognised that there was in fact no defect.

6.3 We shall bear the installation and removal costs only if the item has been installed in or attached to another item in accordance with its type and intended use and we are responsible for the defect that is the cause of the claim for supplementary performance.

6.4 If the supplementary performance fails, the purchaser shall be entitled to choose between withdrawal from the contract or a reduction in the purchase price. However, there is no right of cancellation in the event of an insignificant defect.

6.5 Claims by the purchaser for reimbursement of expenses pursuant to Section 445a (1) BGB are excluded unless the last contract in the supply chain is a purchase of consumer goods.

6.6 We shall be liable in accordance with the statutory provisions if the purchaser asserts claims for damages based on intent or gross negligence, including intent or gross negligence on the part of our representatives or vicarious agents. Insofar as we are not accused of intentional breach of contract, the liability for damages shall be limited to the foreseeable, typically occurring losses.

6.7 We shall be liable in accordance with the statutory provisions if we culpably breach a material contractual obligation; however, even in this case, liability for damages shall be limited to the foreseeable, typically occurring losses. A material contractual obligation exists if the breach of duty relates to an obligation on the fulfilment of which the purchaser has relied and was entitled to rely.

6.8 Liability for culpable injury to life, limb or health shall remain unaffected; this shall also apply to mandatory liability under the Product Liability Act.

6.9 Unless otherwise stipulated above, liability is excluded.

6.10 The limitation period for claims for defects is 12 months, calculated from the transfer of risk.

7. Overall liability

7.1 Any further liability for damages than provided for in clause 6 and clause 4 shall be excluded – regardless of the legal nature of the asserted claim. This shall apply in particular to claims for damages arising from culpa in contrahendo, other breaches of duty or claims in tort for compensation for damage to property pursuant to Section 823 of the German Civil Code (BGB).

7.2 A limitation period of 18 months shall apply to the limitation periods that are not subject to the statute of limitations due to a defect in the item. It begins from knowledge of the damage and the person of the liable party.

7.3 The limitation under clause 7.1 shall also apply insofar as the purchaser demands compensation for futile expenditure instead of a claim for damages in lieu of performance.

7.4 Insofar as our liability for damages is excluded or limited, this shall also apply with regard to the personal liability for damages of our employees, representatives and vicarious agents.

8. Retention of title

8.1 We retain title to the purchased item until receipt of all payments arising from the business relationship with the purchaser. If the purchaser violates its contractual obligation or is in default of payment, we may withdraw from the contract if it does not comply with its obligations after setting a reasonable deadline or if we cannot reasonably be expected to adhere to the contract even without a reminder. We can also declare the withdrawal by taking back the purchased item. After taking back the purchased item, we shall be entitled to dispose of it; the proceeds of disposal shall be set off against the purchaser's liabilities – less reasonable disposal costs.

8.2 Until the final transfer of ownership, the purchaser is obliged to treat the purchased item with care; in particular, it is obliged to adequately insure it at his own expense against losses due to fire, water and theft at replacement value. If maintenance and inspection work is required, the purchaser must carry this out in good time at its own expense.

8.3 In the event of distraint proceedings or other interventions by third parties, the purchaser must notify us immediately in writing so that we can take legal action in accordance with Section 771 of the German Code of Civil Procedure (ZPO). Insofar as the third party is not in a position to reimburse us for the court and out-of-court costs of an action in accordance with Section 771 ZPO (German Code of Civil Procedure), the purchaser shall be liable for the losses incurred by us.

8.4 The purchaser shall be entitled to resell the purchased item in the ordinary course of business; however, he hereby cedes all claims in the amount of the final invoice amount (including VAT) of our claim accruing to him from the resale against his customers or third parties, irrespective of whether the purchased item has been resold without or after processing. The purchaser shall remain authorised to collect this claim even after the cession. Our authorisation to collect the claim ourselves remains hereby unaffected. However, we undertake not to collect the claim as long as the purchaser meets his payment obligations from the proceeds collected, is not in default of payment and, in particular, has not filed for insolvency proceedings or suspended payments. However, if this is the case, we may demand that the purchaser inform us of the ceded claims and their debtors, provide all information required for collection, hand over the relevant documents and inform the debtors (third parties) of the cession. The claim ceded by us in advance also refers to the acknowledged balance, as in the case of insolvency of the customer to the then existing causal balance.

8.5 The processing or transformation of the purchased item by the purchaser shall always be carried out for us. If the purchased item is processed with other objects not belonging to us, we shall acquire co-ownership of the new object in the ratio of the value of the purchased item (final invoice amount, including VAT) to the other processed objects at the time of processing. In all other respects, the same shall apply to the item created by processing as to the purchased item supplied subject to reservation of title.

8.6 If the purchased item is inseparably combined with other items not belonging to us, we shall acquire co-ownership of the new item in the ratio of the value of the purchased item (final invoice amount, including VAT) to the other mixed items at the time of mixing. If the combination takes place in such a way that the customer's item is considered to be the main item, it is agreed that the purchaser shall transfer co-ownership to us on a pro rata basis. The purchaser shall preserve the sole ownership or co-ownership thus created on our behalf.

8.7 The purchaser also assigns to us the claims to secure our claims against him which arise against a third party through the connection of the purchased item with a property.

8.8 We undertake to release the securities to which we are entitled at the request of the purchaser to the extent that the realisable value of our securities exceeds the claims to be secured by more than 10 %; the selection of the securities to be released shall be incumbent upon us.

9. Jurisdiction - Place of performance - Severability clause

9.1 If the purchaser is a merchant, the place of jurisdiction for all disputes arising shall be Sundern (Sauerland), to the exclusion of other places of jurisdiction; however, we shall also be entitled to sue the customer at its general place of jurisdiction.

9.2 The law of the Federal Republic of Germany shall apply; the validity of the UN Convention on Contracts for the International Sale of Goods (CISG) is excluded.

9.3 Unless otherwise stated in the order confirmation, the place of performance for all services and consideration, including payments, shall be our headquarters in Sundern (Sauerland).

9.4 These General Terms and Conditions of Sale shall remain valid even if individual clauses prove to be invalid. The invalid clause shall be supplemented or reinterpreted by the parties in such a way that the commercial purpose intended by the invalid provision is as far as possible achieved. The same procedure shall be followed if a loophole requiring supplementation arises during the performance of the contractual relationship. If the invalidity is based on a performance or time provision, it shall be replaced by the legally permissible measure. Should any provision of these General Terms and Conditions of Sale be invalid with regard to mandatory foreign law, the purchaser shall, upon request, agree with us such contractual supplements and make such declarations to third parties or authorities as will ensure the validity of the provision concerned and, if this is not possible, its commercial content also under the foreign law.

9.5 The German version of the General Terms and Conditions of Sale is the authoritative version. It shall take precedence over the English translation and is designed in accordance with German case law.

Status: January 2024

Colour coding



02 = chrome



15 = matt nickel



18 = textured black



03 = matt chrome



16 = textured silver



25 = matt aluminium

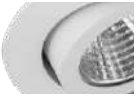

07 = white



17 = textured white



68 = silver



08 = black

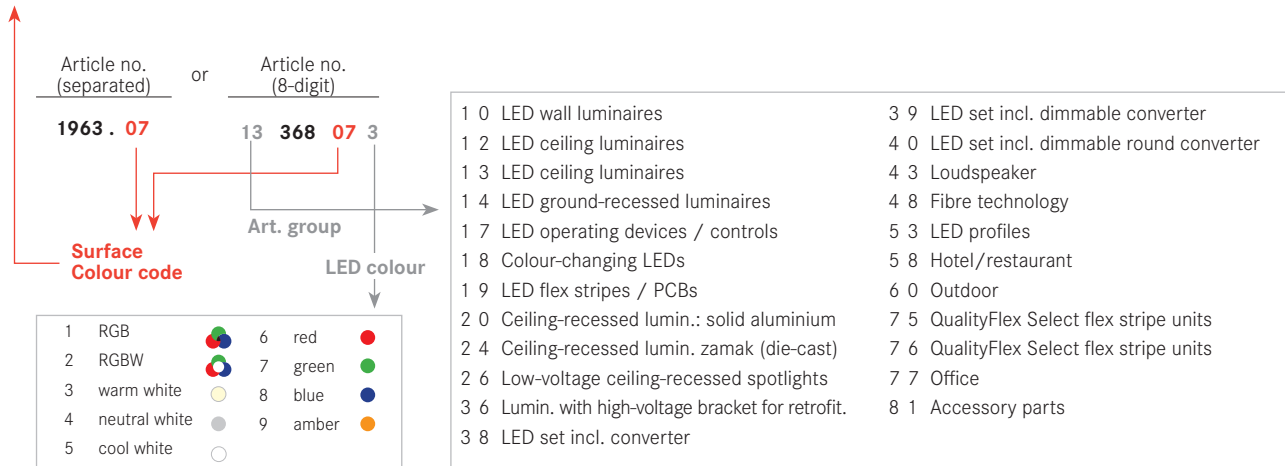

*Special product.

Note! The product with the colour temperature red, green, blue or amber is a special product. This product, with these colour temperatures, is used for coloured lighting. The spectral distribution of light is used to change the appearance of illuminated scenes or objects in addition to making them visible. The product is not intended for use in other applications. The special product is not suitable for home room illumination.

Degrees of protection

The **degree of protection** of a luminaire indicates its protection against the ingress of foreign bodies and moisture. The designation has the following structure: IP XX. The letters IP stand for the degree of protection and the placeholders are substituted as follows. 1. Position: foreign body protection, 2. Position: water ingress protection

Digits for protection against accidental contact / foreign object protection



















































| | |
|-------|--|
| IP 0X | No protection |
| IP 1X | Protected against solid objects larger > 50 mm. |
| IP 2X | Protected against solid objects larger > 12 mm. |
| IP 3X | Protected against solid objects larger > 2.5 mm. |
| IP 4X | Protected against solid objects larger > 1 mm. |
| IP 5X | Dust protected |
| IP 6X | Dust-tight |

Example: IP 44 means protected against solid objects > 1 mm and against spraying water.

Digits for water protection

| | |
|-------|--|
| IP X0 | No protection against ingress of water |
| IP X1 | Protection against vertically dripping water |
| IP X2 | Protection against dripping water when tilted at an angle (of 15° from the vertical) |
| IP X3 | Protection against spraying water (up to 60° from the vertical) |
| IP X4 | Protection against splashing of water |
| IP X5 | Protection against water jets |
| IP X6 | Protected against powerful water jets |
| IP X7 | Protection against immersion, up to 1 meter |
| IP X8 | Protection against immersion, more than 1 meter |

Pictograms

| | | | | | |
|---|--|---|--|---|---|
|  | Connection as a parallel circuit (constant voltage) |  | Lights for installation in furniture made of materials with unknown fire behaviour |  | IP... Protection class, Explanation see bottom left |
|  | Connection as a series circuit (constant current) |  | Not suitable for installation in device/ mounting boxes |  | V4A Article is made partly of V4A stainless steel and is suitable for use near the coast. |
|  | Luminaire operating current corresponds to the mA-Specification (constant current) |  | Rotation angle in various directions in ° |  | Moisture impregnated membrane |
|  | Luminaire operating voltage 12 V direct current (DC) |  | Cardan rotation angle in ° |  | VDE certification |
|  | Luminaire operating voltage 24 V direct current (DC) |  | Swivel angle in ° |  | ENEC certification |
|  | Luminaire operating voltage 230 V alternating current (AC) |  | Impact resistance / mechanical stress resistance |  | Load capacity in kg |
|  | Luminaire installation depth in mm The specified installation depth is the mechanical installation depth (pure luminaire depth)! For the actual installation depth please refer to the installation instructions. |  | Luminaire fixing WITHOUT visible snap ring |  | Article not suitable for covering with thermal insulation material |
|  | Ceiling cut-out circular (Ø) or square in mm |  | Specification of the suitable bracket for the article. Note: LV luminaires are generally Supplied WITHOUT hangers. Please order if required! |  | Article is equipped with our Plug&Play systems for easy connection. Miswiring is impossible. |
|  | Protection class I: with protective earthing (PE) |  | Dimmable via leading-edge and/or trailing-edge phase dimmer |  | Maximum luminous flux in lumens. Exact values are available on request. Measurement in accordance with EN 13032: this standard defines the measurement methods (e.g. using goniophotometers) and the presentation of photometric data (light distribution curve) for luminaires and lamps. |
|  | Protection class II: protective insulation (e.g. with plastic housing or reinforced or double insulation) |  | Dimmable via 1-10 V interface |  | This article can be controlled by Bluetooth. |
|  | Protection class III: protective extra-low voltage: voltages <=50 V AC; <=120 V DC |  | Dimmable via DALI BUS |  | For these articles, light distribution curves are available for download at www.brumberg.com . |
|  | Ambient temperature (LED flex stripes) |  | Dimmable via DALI BUS 2 |  | Short pitch: distance from LED chip centre to LED chip centre (LED flex stripes) |
|  | Nominal service life at 100 % BLF (escape sign luminaires) |  | Lights are also compatible with all other MR16s |  | Solder the connecting cable (LED flex stripes) |
|  | Nominal service life at 40 % BLF (escape sign luminaires) |  | LED number per metre (LED flex stripes) |  | Detection distance in m (escape sign luminaires) |
|  | D-marking. Luminaires for fire-hazardous premises. Maximum temperature of horizontal surfaces during normal operation 90 °C. Maximum glass surface temperature 150 °C. |  | Dimmable (LED flex stripes) |  | Non-replaceable light source |
|  | LED-light source replaceable by the end-user |  | LED light source replaceable by a qualified person |  | Light source replaceable by a qualified person |
|  | Light source replaceable by the end-user |  | Motion sensor | | |

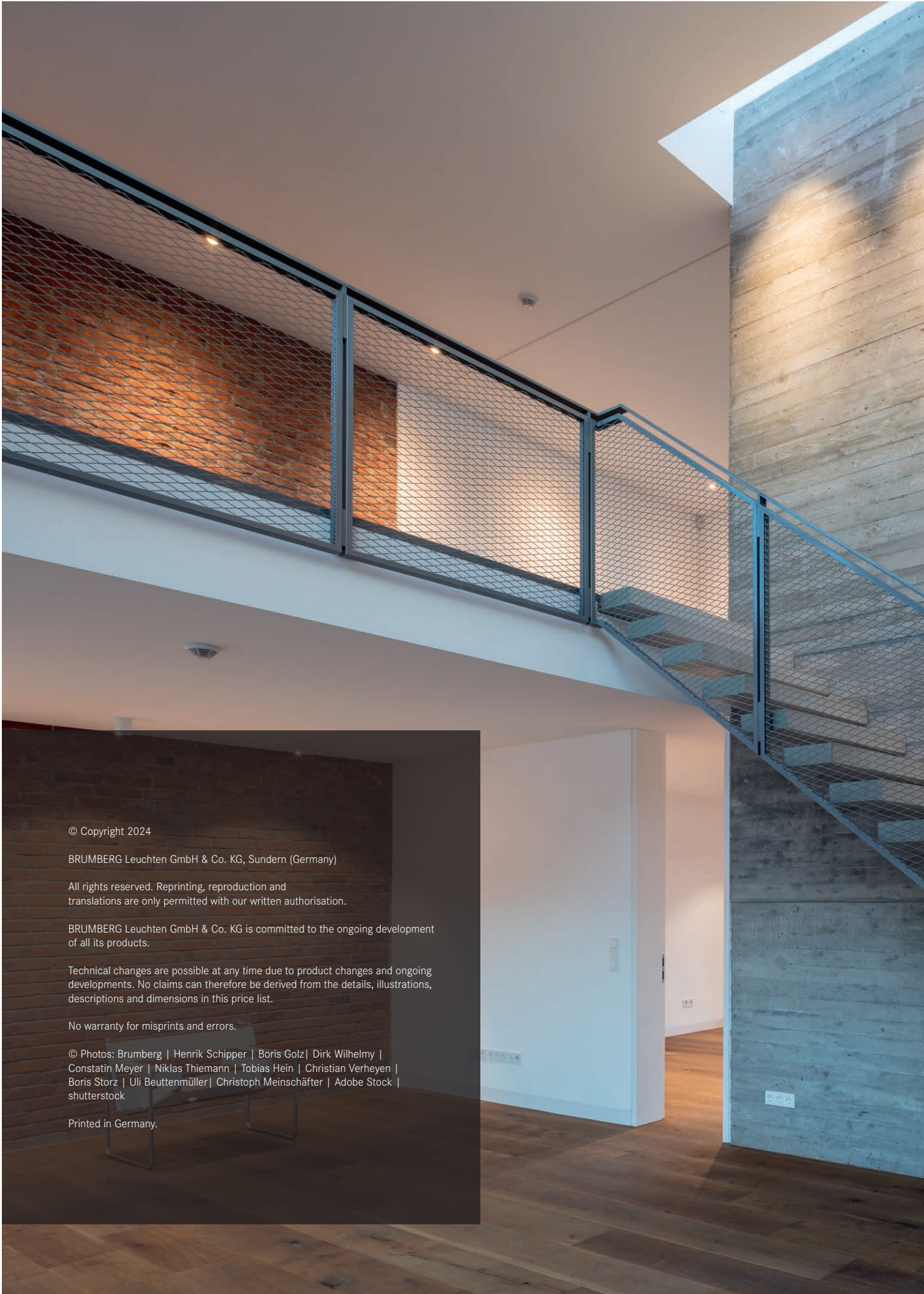

© Copyright 2024

BRUMBERG Leuchten GmbH & Co. KG, Sundern (Germany)

All rights reserved. Reprinting, reproduction and translations are only permitted with our written authorisation.

BRUMBERG Leuchten GmbH & Co. KG is committed to the ongoing development of all its products.

Technical changes are possible at any time due to product changes and ongoing developments. No claims can therefore be derived from the details, illustrations, descriptions and dimensions in this price list.

No warranty for misprints and errors.

© Photos: Brumberg | Henrik Schipper | Boris Golz | Dirk Wilhelmy | Constatin Meyer | Niklas Thiemann | Tobias Hein | Christian Verheyen | Boris Storz | Uli Beuttenmüller | Christoph Meinschäfer | Adobe Stock | shutterstock

Printed in Germany.



5 years Lighting guarantee

The BRUMBERG quality promise.

5-year lighting guarantee

Brumberg luminaires fulfil the highest standards of material and manufacturing quality. That is something we guarantee with the Brumberg quality promise. The lighting guarantee represents an upgrade to the statutory two-year warranty period.

Unrestricted product confidence in our luminaire systems and controls forms the basis for the lighting guarantee. Whenever you buy a Brumberg product we guarantee, within the framework of the warranty conditions, its perfect quality and function over the period of 5 years.

The lighting guarantee is completely free of charge and applies to our specialist partners from the trade.

The five-year guarantee is only valid after registration on the website.

www.brumberg.com/en/brumberg-warranty/



BRUMBERG

BRUMBERG Leuchten GmbH & Co. KG
Hellefelder Str. 63 | 59846 Sundern (Germany)
Phone: +49 (0) 29 34 / 96 11 0 | Fax: +49 (0) 29 34 / 96 11 96
info@brumberg.com | www.brumberg.com

PREMIUM | **MARKEN**
Partner 

BRUMBERG products are available exclusively from your electrical subcontractor. According to DIN VDE 0100 electrical equipment may only be installed by a qualified electrician.

